

















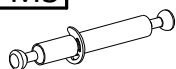

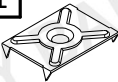

HAPPY SZ10-A

INSTRUKCJA MONTAŻU ASSEMBLY INSTRUCTIONS

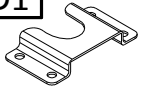
Narzędzia / Tools

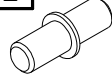
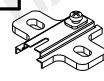
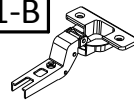
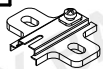
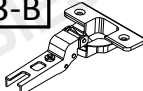

Akcesoria / Fittings

Q1  1 szt. / pcs	W4  Ø4 × 16 98 szt. / pcs	W5  Ø4 × 35 1 szt. / pcs	W6  Ø6.3 × 50 24 szt. / pcs	G1  24 szt. / pcs	M1  6 szt. / pcs	M3  3 szt. / pcs
Q2  1 szt. / pcs	K1  Ø8 × 35 6 szt. / pcs	K2  Ø8 × 60 2 szt. / pcs	S1  6 szt. / pcs	T1  14 szt. / pcs	N1  8 szt. / pcs	N2  8 szt. / pcs
U1  6 szt. / pcs	U2  Ø4 × 30 6 szt. / pcs	D1  2 szt. / pcs	D4  842 mm 1 szt. / pcs	B1  20 szt. / pcs	Z1-A  10 szt. / pcs	Z1-B  10 szt. / pcs
Z3-A  5 szt. / pcs	Z3-B  5 szt. / pcs	L3  1266 mm 1 szt. / pcs	TZ1  1 szt. / pcs	ZM1  6 szt. / pcs	ZW1  24 szt. / pcs	

**DO MONTAŻU POTRZEBNE SĄ DWIE OSOBY!
INSTALLATION REQUIRES TWO PEOPLE!**

BARDZO WAŻNE!
NALEŻY UWAŻNIE PRZECZYTAĆ
ZACHOWAĆ DO PÓŹNIEJSZEGO STOSOWANIA

INSTRUKCJA OBSŁUGI

1.

By zapobiec zadławieniu lub uduszeniu opakowanie z akcesoriami należy trzymać w miejscu niedostępnym dla niemowląt i dzieci.

2.

Wszystkie połączenia w meblu muszą być dobrze dokręcone, żaden z elementów łączących nie może być luźny.

3.

Nie należy używać szafy jeśli jakikolwiek element jest uszkodzony lub brakuje elementu.

4.

Należy używać tylko elementów dopuszczonych przez producenta.

5.

Nie należy w pobliżu szafy umieszczać otwartych źródeł ognia oraz innych silnych źródeł ciepła, jak promienniki gazowe lub elektryczne itp., gdyż grozi to pożarem.

6.

Szafę należy przytwierdzić do ściany za pomocą dołączonej taśmy zabezpieczającej!

VERY IMPORTANT!
PLEASE READ CAREFULLY
SAVE FOR FUTURE USE
USER'S MANUAL

1.

To avoid the danger of choking or strangulation keep the package with fittings away from babies and children.

2.

All connections must be tightened properly and no coupled element can not be loose.

3.

Do not use the wardrobe when, if any of the elements is damaged or if there is any element missing.

4.

Use only the elements given by manufacturer.

5.

Do not place the wardrobe near naked flames or other heat sources such as electric or gas radiators etc., this may cause a fire.

6.

The wardrobe must be fixed to the wall using the supplied roll-over protection tape!

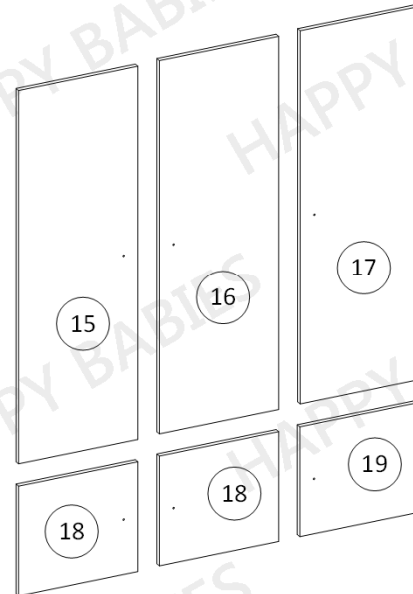
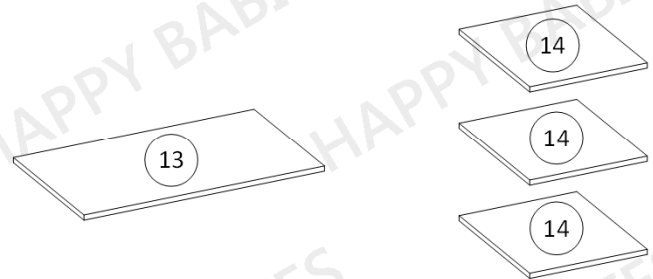
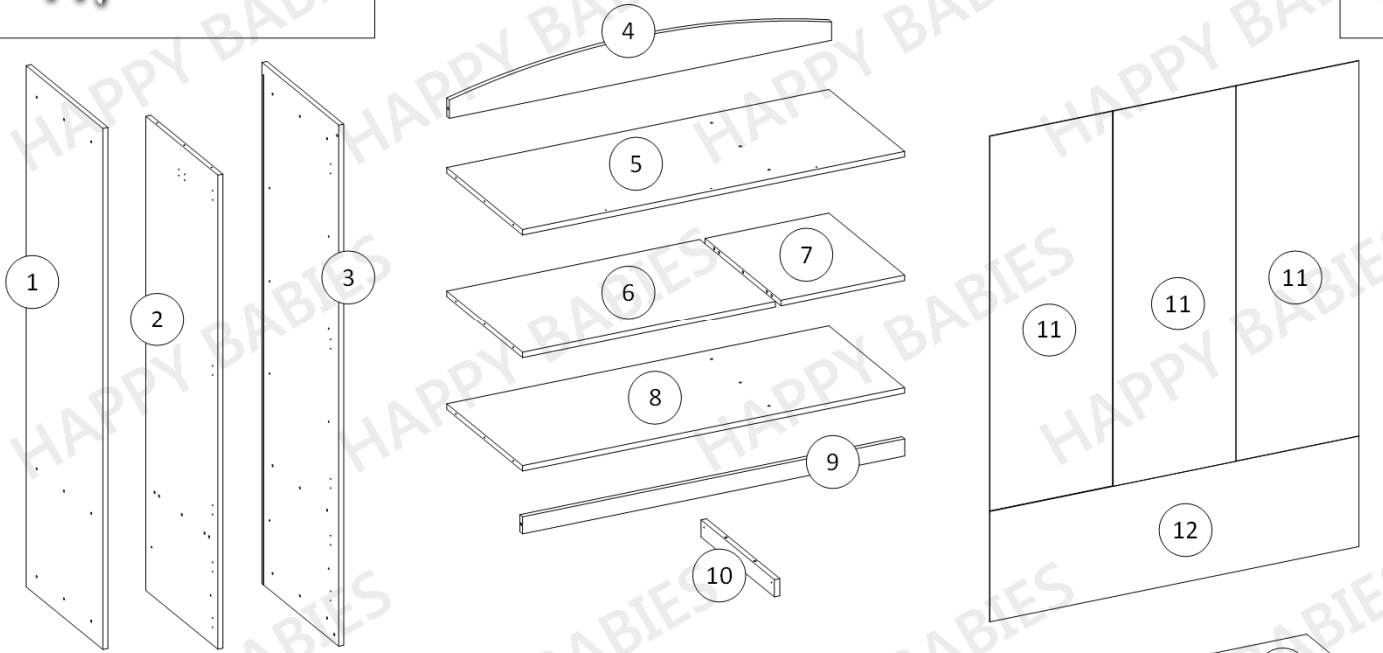

Paczka 1 z 3 / Package 1 of 3

Numer elementu / Item no.	Wymiary (mm) / Dimensions (mm)	Ilość / Quantity
1	1800 x 540 x 18	1
14	414 x 497 x 18	1
15	425 x 1290 x 18	1
16	425 x 1290 x 18	1
17	420 x 1290 x 18	1
19	420 x 378 x 18	1

Paczka 2 z 3 / Package 2 of 3

Numer elementu / Item no.	Wymiary (mm) / Dimensions (mm)	Ilość / Quantity
2	1638 x 507 x 18	1
3	1800 x 540 x 18	1
11	431 x 1292 x 3	3
12	1296 x 380 x 3	1
14	414 x 497 x 18	2
18	425 x 378 x 18	2

Paczka 3 z 3 / Package 3 of 3

Numer elementu / Item no.	Wymiary (mm) / Dimensions (mm)	Ilość / Quantity
4	1278 x 140 x 18	1
5	1278 x 507 x 18	1
6	846 x 507 x 18	1
7	414 x 507 x 18	1
8	1278 x 507 x 18	1
9	1278 x 56 x 18	1
10	487 x 56 x 18	1
13	846 x 497 x 18	1
14	414 x 497 x 18	1

PRZED MONTAŻEM MEBLA NALEŻY DOKŁADNIE SPRAWDZIĆ CZY PACZKI ZAWIERAJĄ WSZYSTKIE ELEMENTY WYSZCZEGÓLNIONE W TABELCE NA STRONIE 3 ORAZ CZY ELEMENTY TE NIE SĄ USZKODZONE !!! JEŚLI BRAKUJE ELEMENTÓW LUB NIEKTÓRE Z NICH SĄ USZKODZONE PROSIMY O KONTAKT Z NASZYM BIUREM OBSŁUGI KLIENTA. USZKODZENIA ELEMENTÓW STWIERDZONE JUŻ PO MONTAŻU MEBLA NIE BĘDĄ UWZGLĘDNIANE !!!

BEFORE ASSEMBLING THE FURNITURE PLEASE CHECK THAT PACKAGES INCLUDE ALL ITEMS LISTED IN THE TABLE ON PAGE NO 3, AND WHETHER THESE ITEMS ARE NOT DAMAGED !!! IF MISSING PARTS OR SOME OF THEM ARE DAMAGED, PLEASE CONTACT OUR CUSTOMER SERVICE OFFICE. DAMAGES FOUND AFTER ASSEMBLING WILL NOT BE CONSIDERED !!!

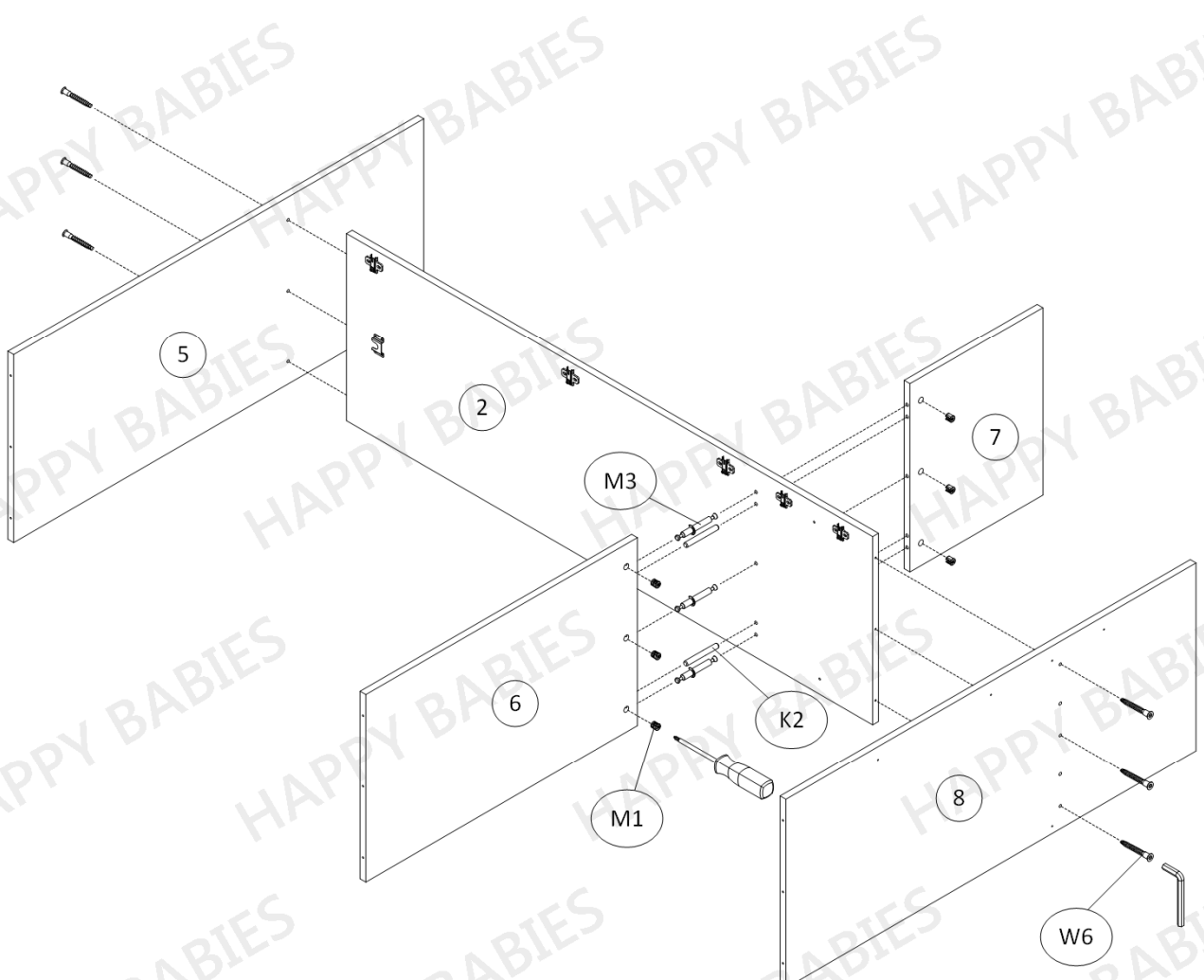
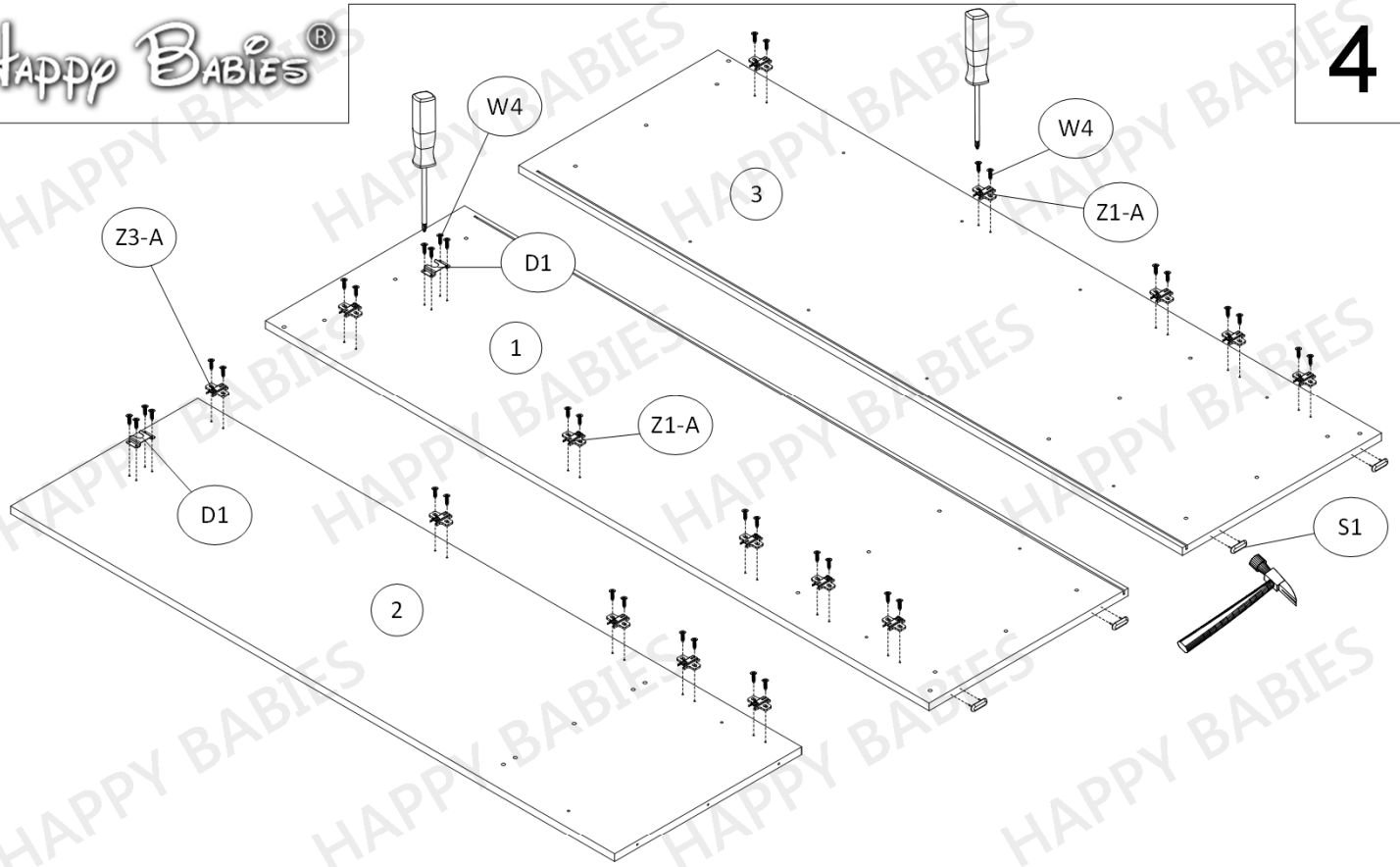

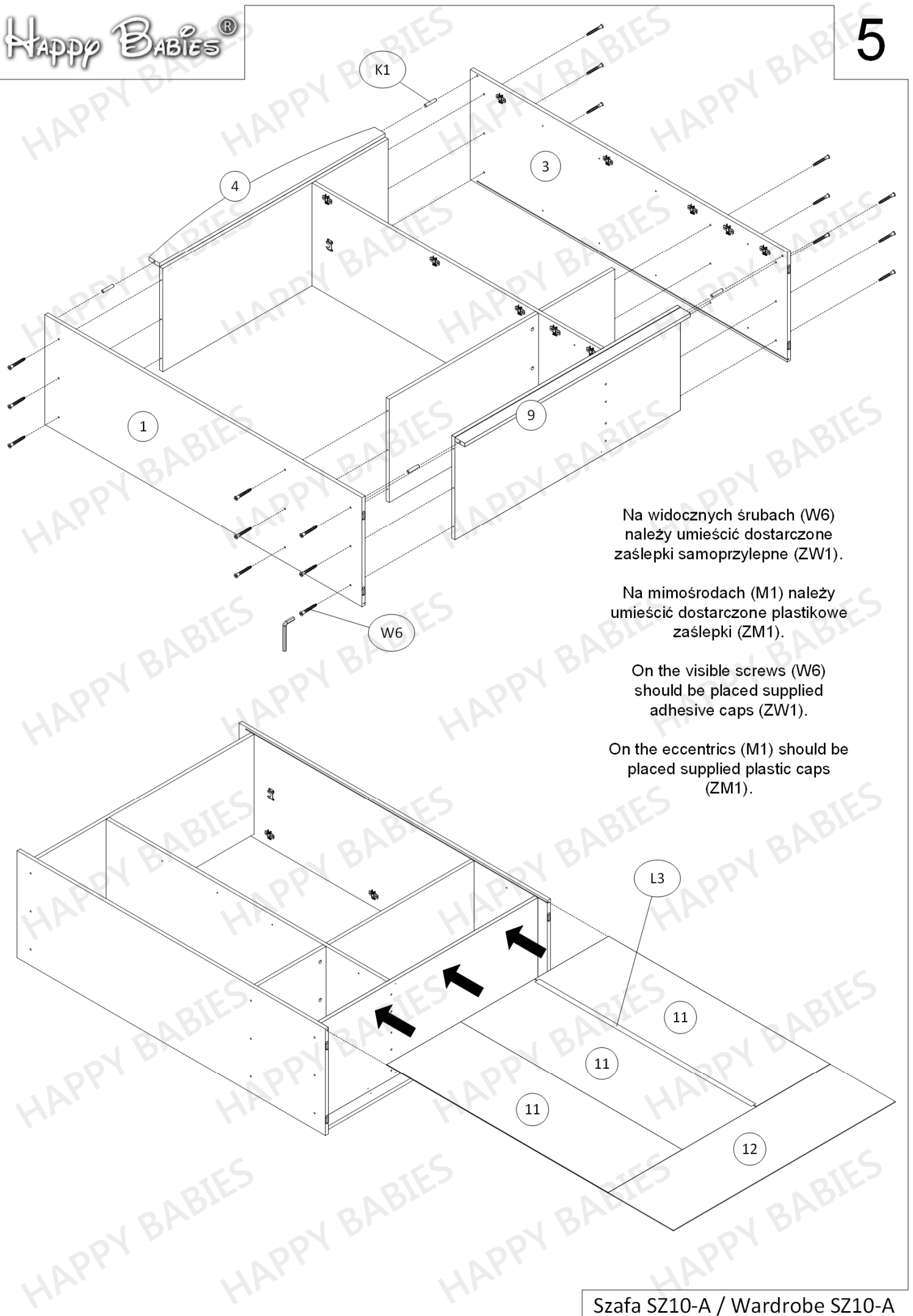

Na widocznych śrubach (W6) należy umieścić dostarczone zaślepki samoprzylepne (ZW1).

Na mimośrodkach (M1) należy umieścić dostarczone plastikowe zaślepki (ZM1).

On the visible screws (W6) should be placed supplied adhesive caps (ZW1).

On the eccentrics (M1) should be placed supplied plastic caps (ZM1).

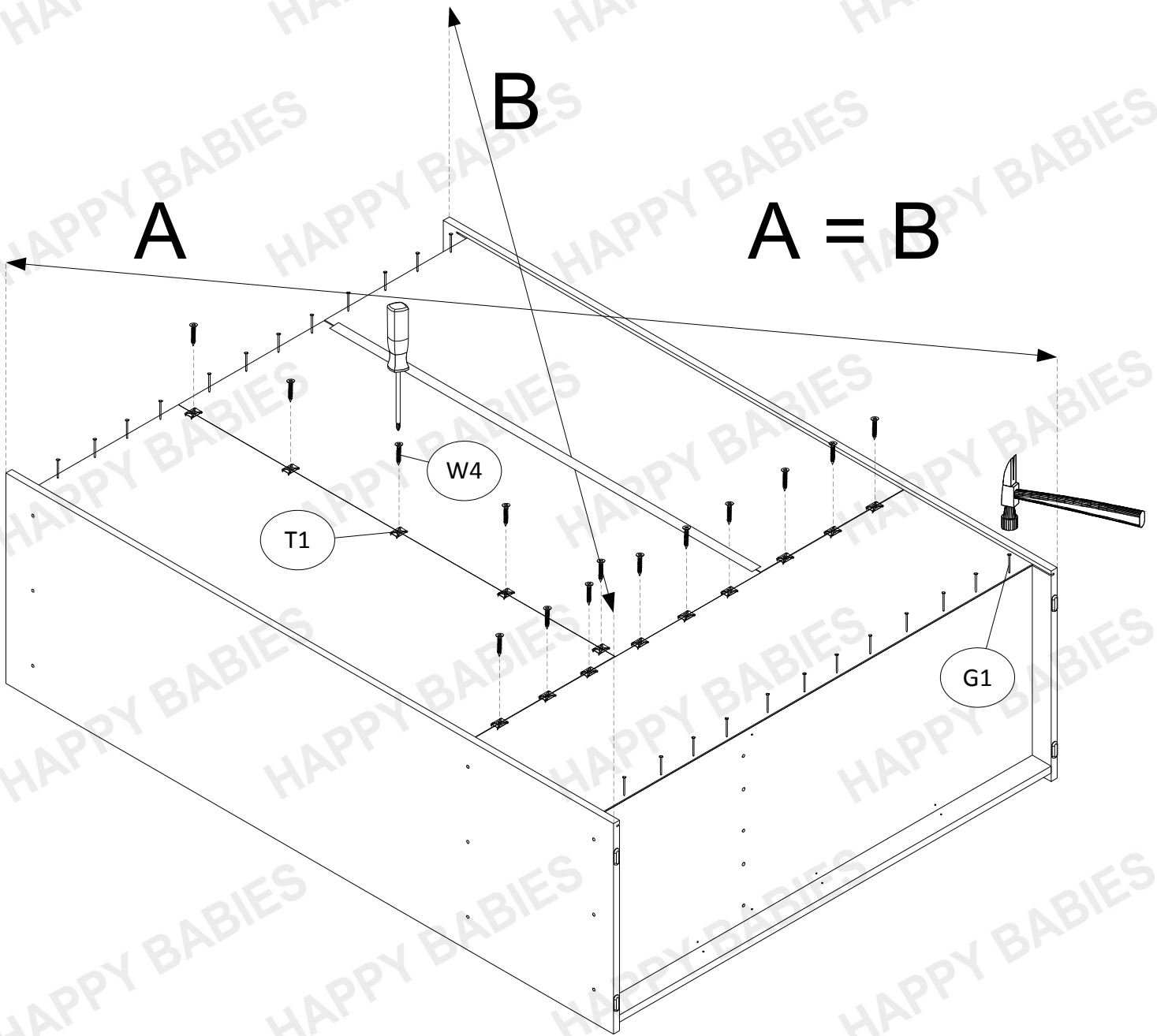

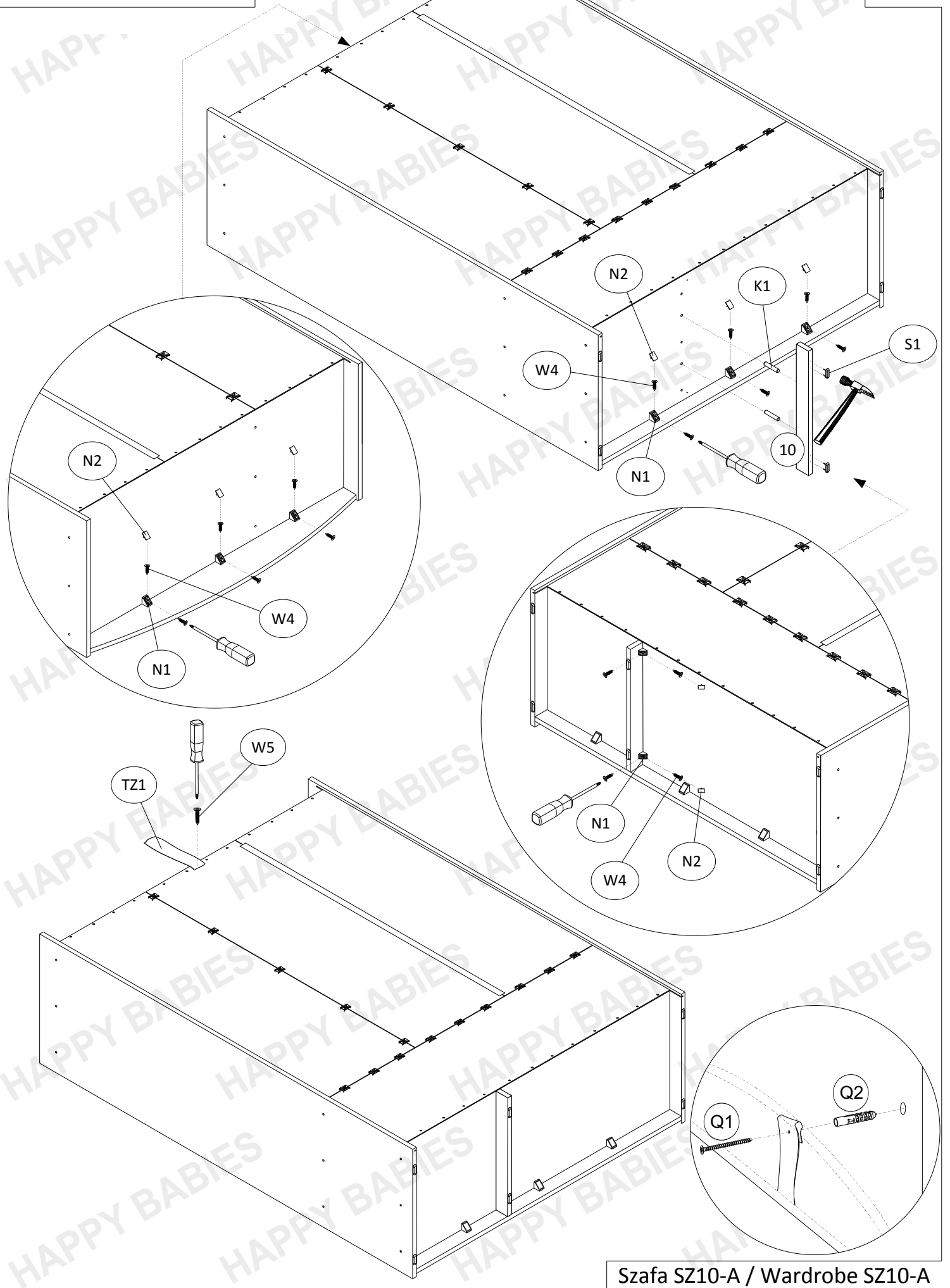

Szafa SZ10-A / Wardrobe SZ10-A

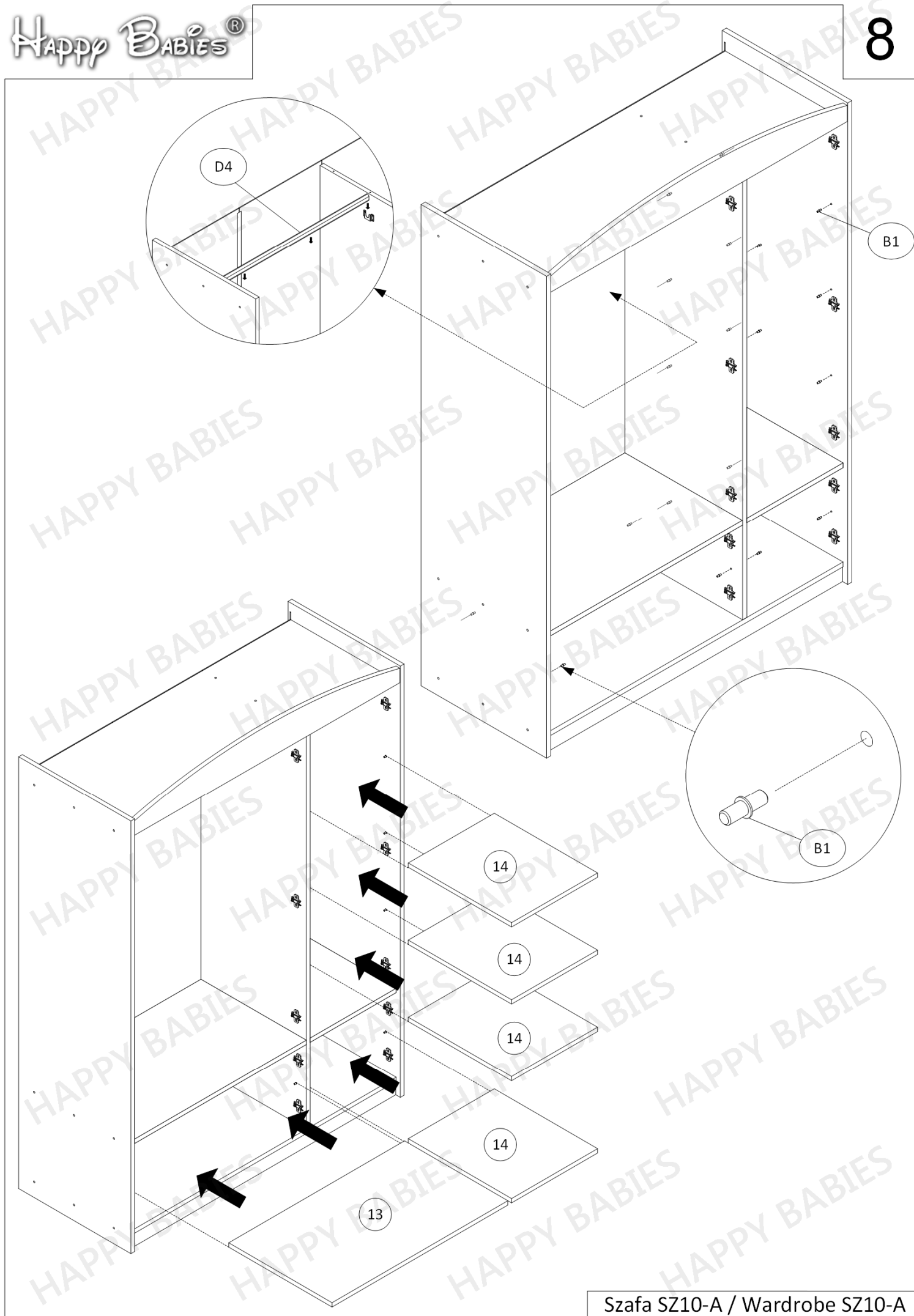

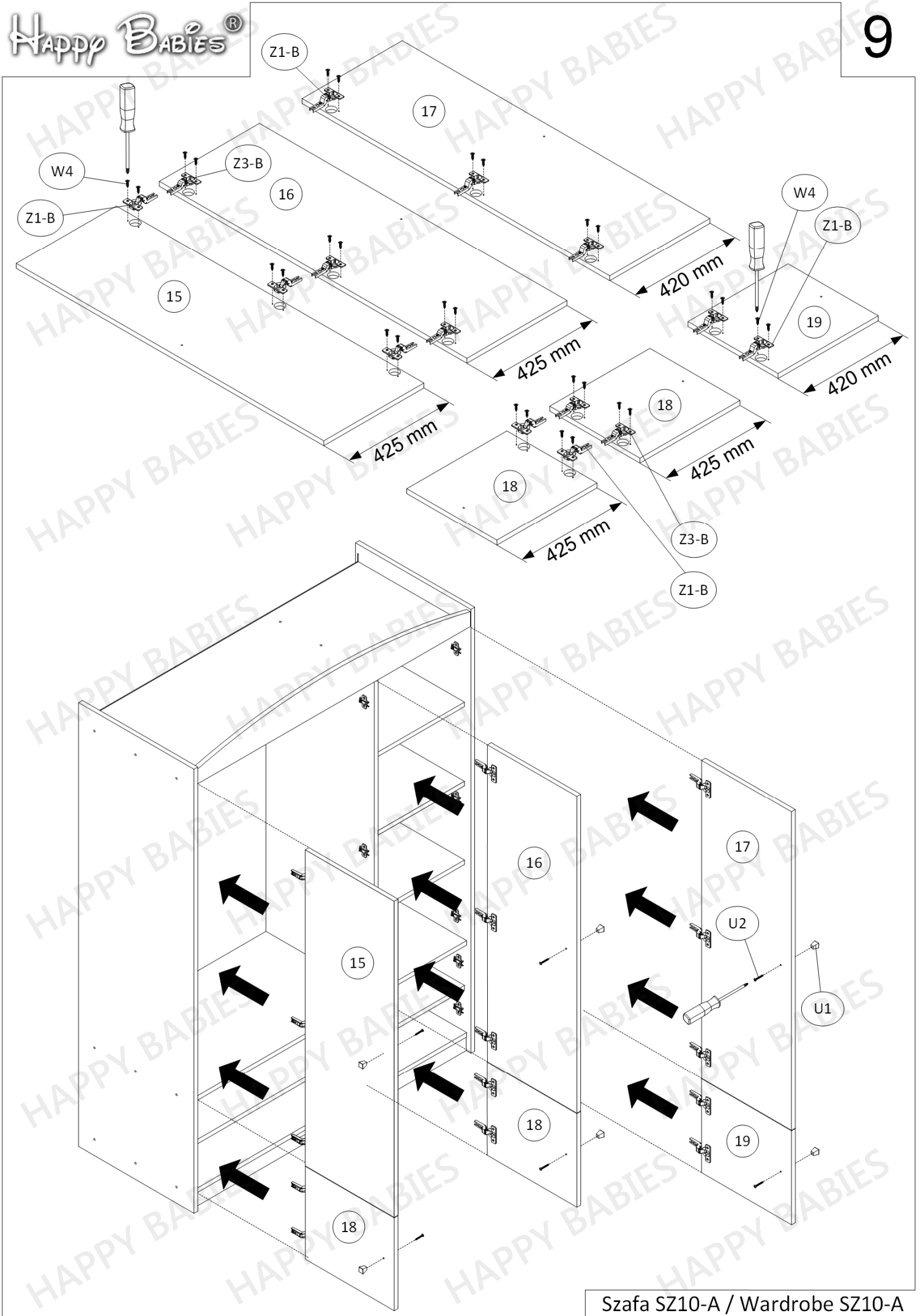

Szafa SZ10-A / Wardrobe SZ10-A