

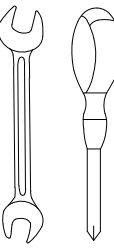

# MAGGIE

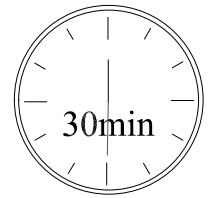

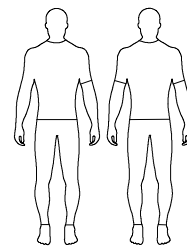
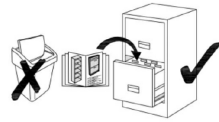
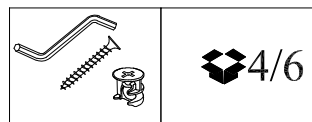
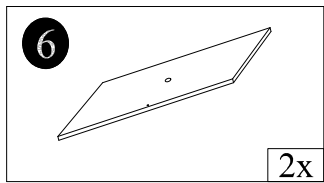
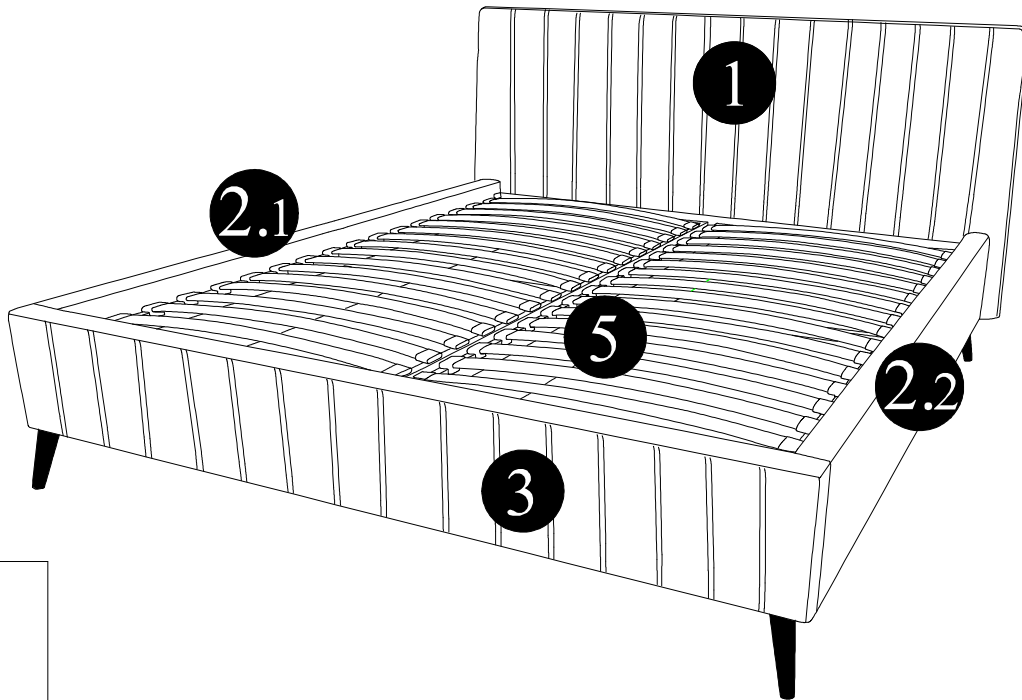

Teil	L	W	H	Pcs	Colli	Teil	L	W	H	Pcs	Colli
1	95	160/180/200	13	1x	1/6	4	12	18	32	1x	4/6
2.1	27	203	36	1x	2/6	5				1x	5/6
2.2	27	203	36	1x	2/6	6	100	142/162/182	7	2x	6/6
3	16	158/178/198	32	1x	3/6	7				1x	1/6

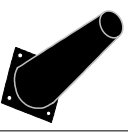
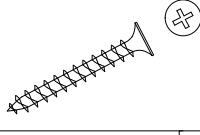

A	B	C	D	E	F	G	H
4x	17x	2x	6x	1x	1x	2x	1x
H-140	3,5x35	H-140		H-155	Ø60	3,5x70	H-110

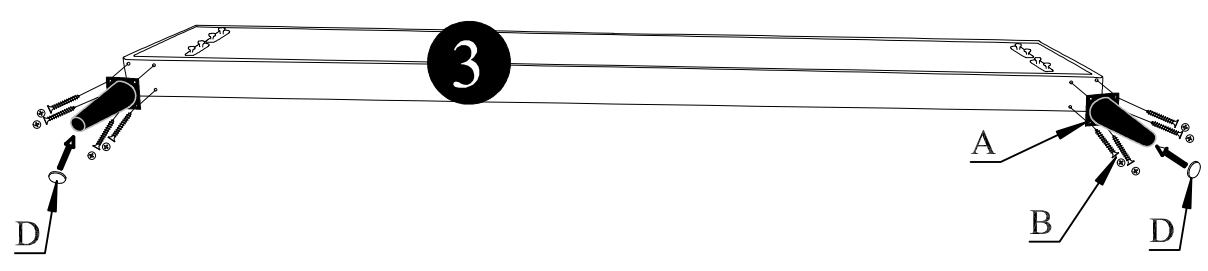
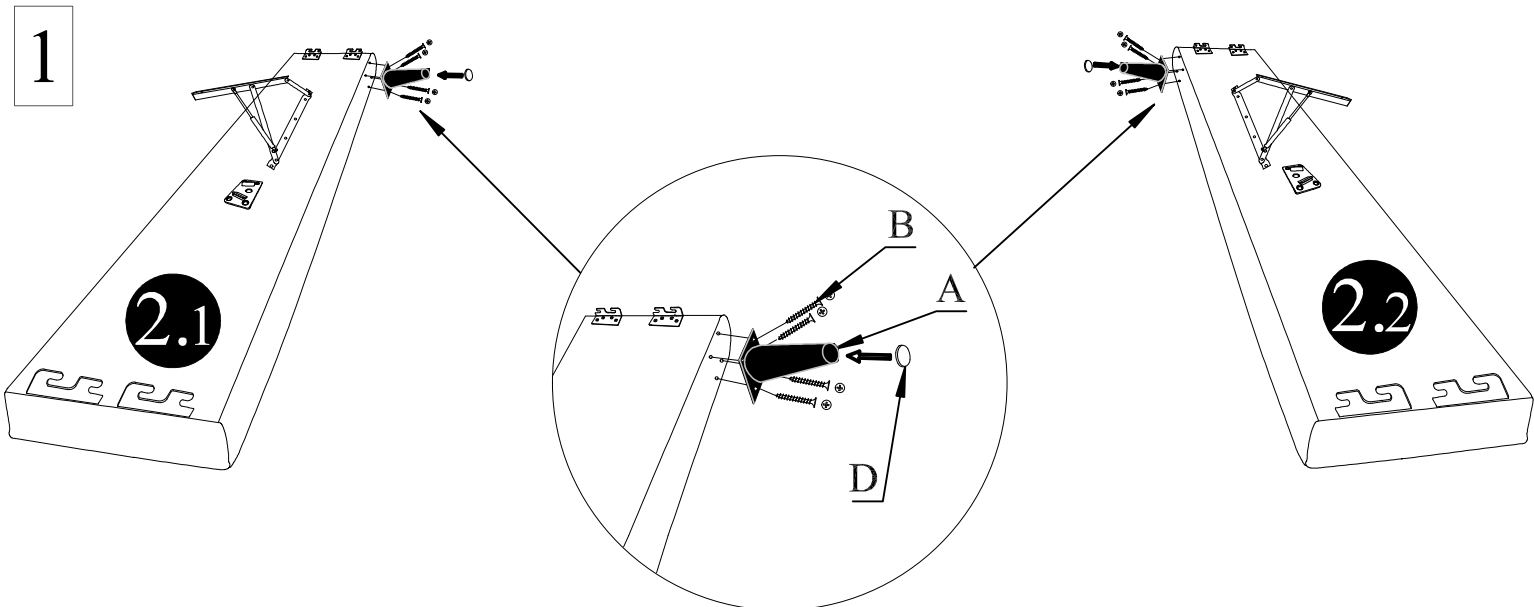
A		B		D	
	H-140	4x	3,5x35	16x	2x



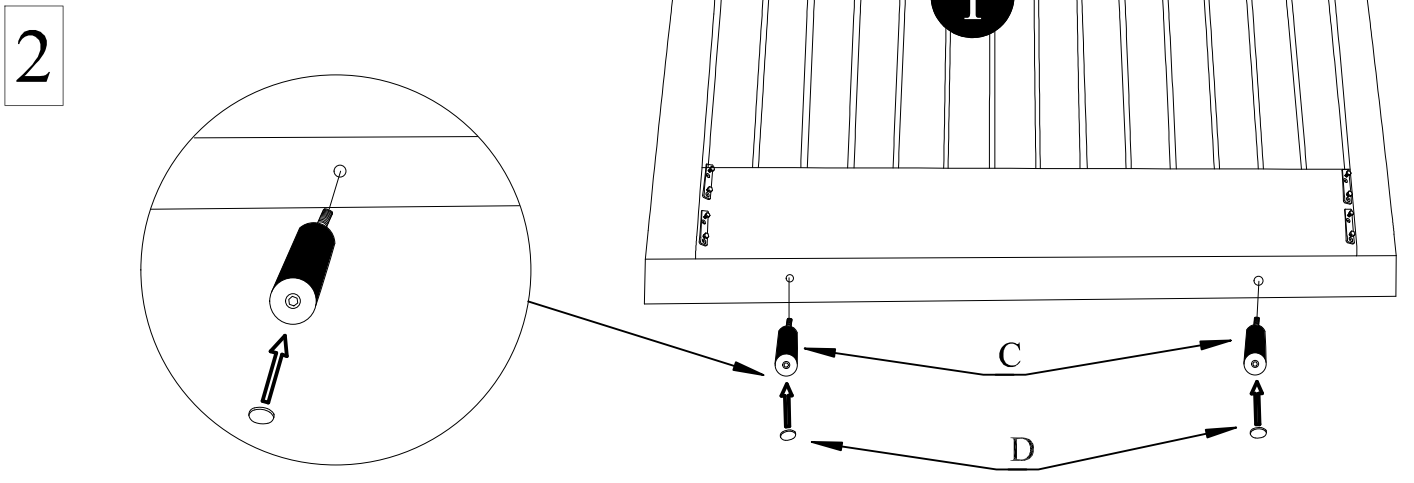

C		D	
	H-140	2x	2x

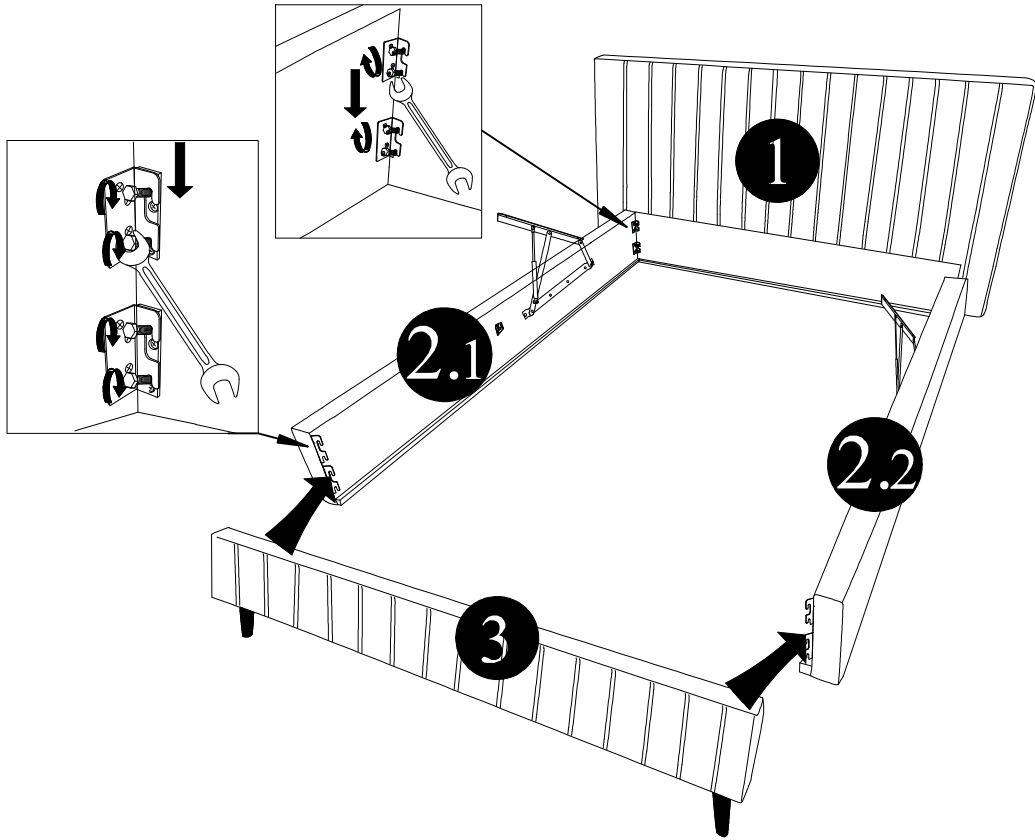

3

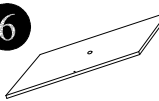

B	E	F	6
 3,5x35	 H-155	 Ø60	 1x

4

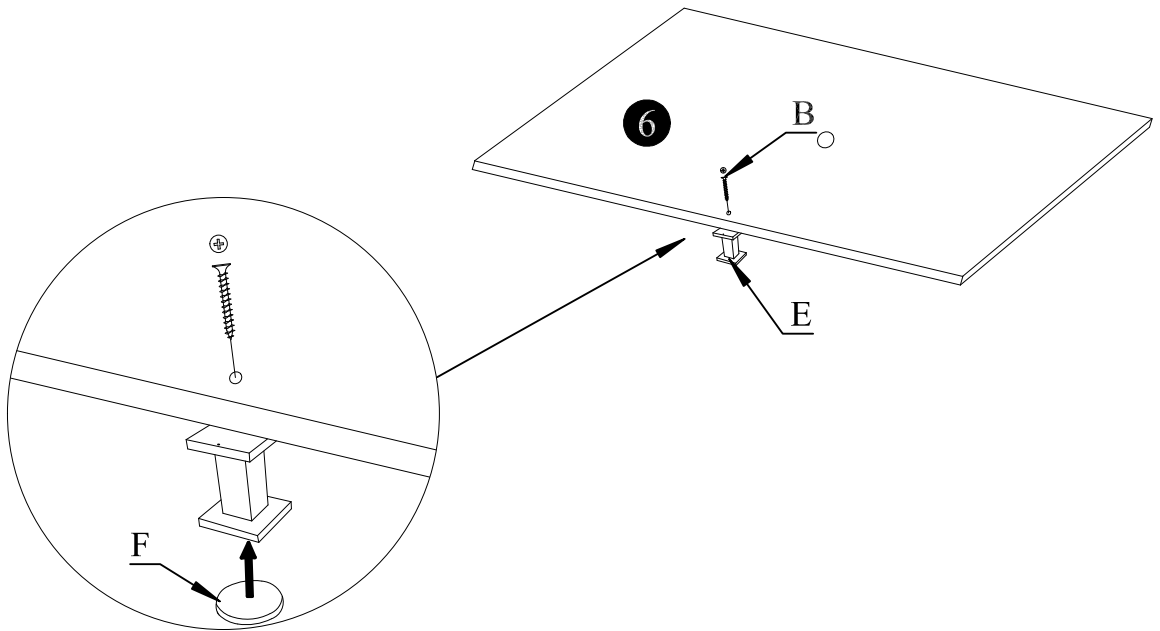

5

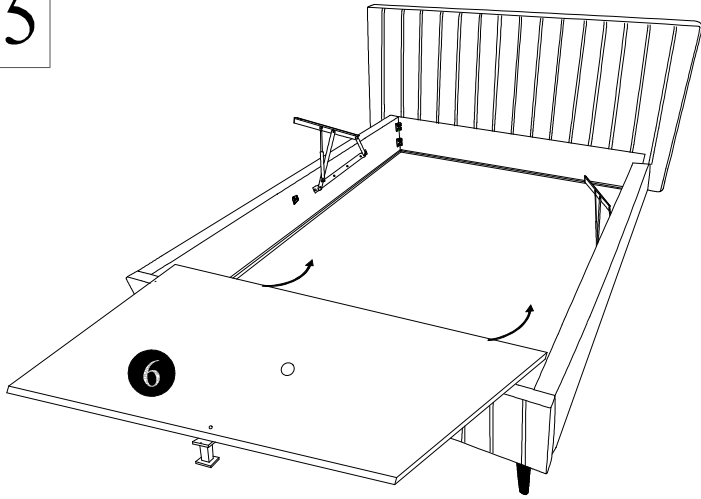

6

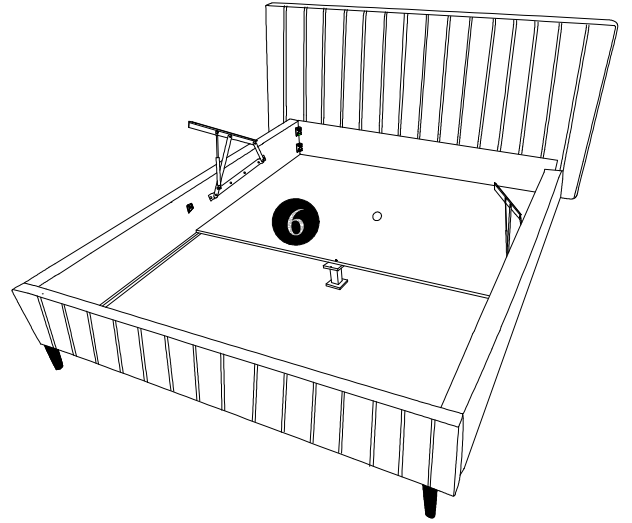

7

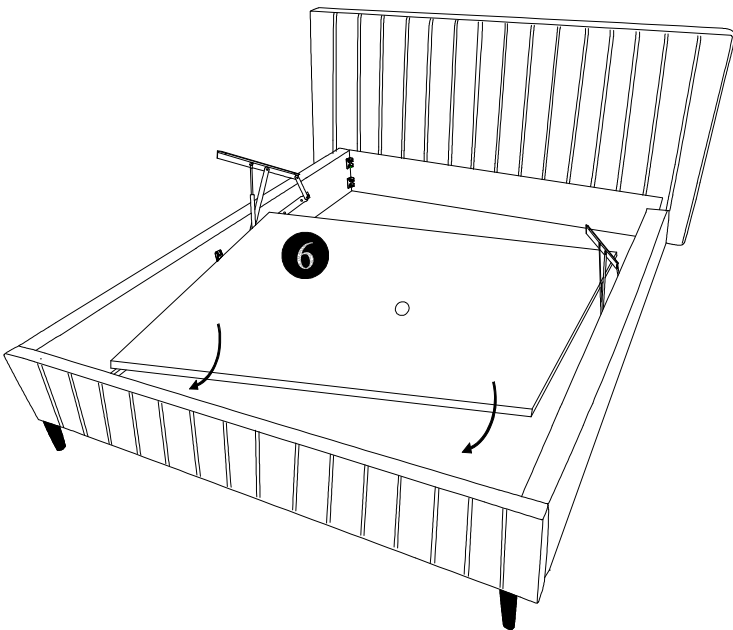
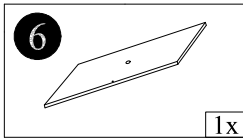

8

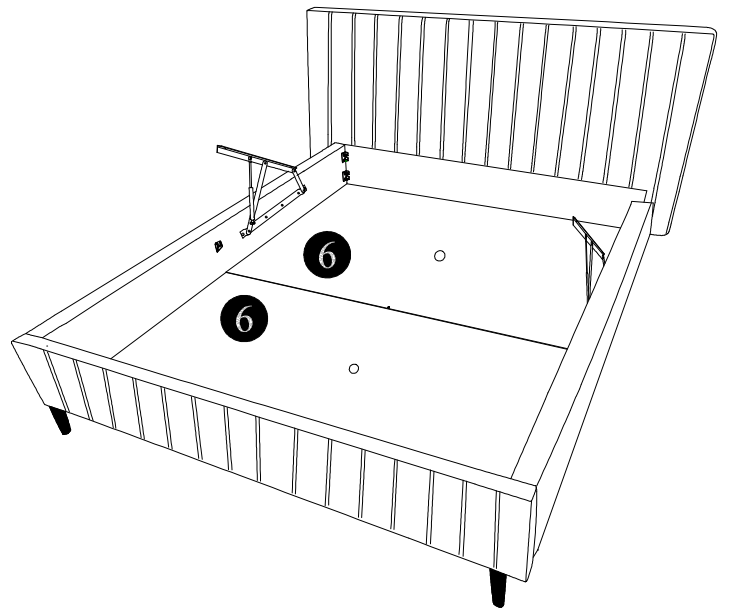

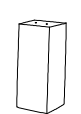
<b>G</b>  2x 3,5x70	<b>H</b>  1x H-110
--	--

9

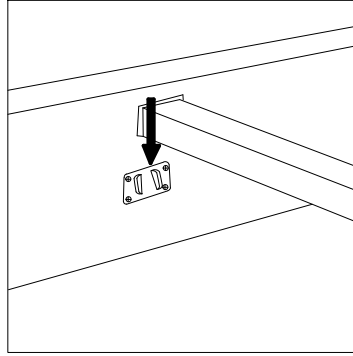
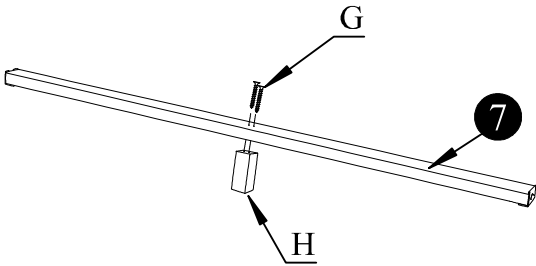

10

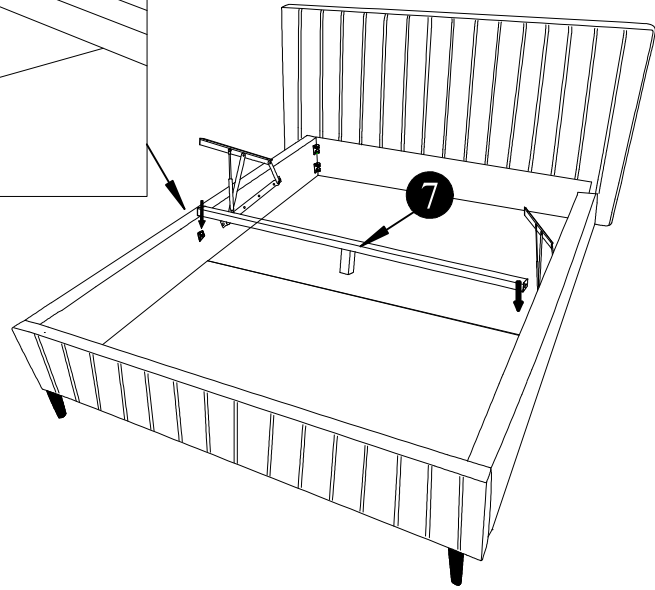

11

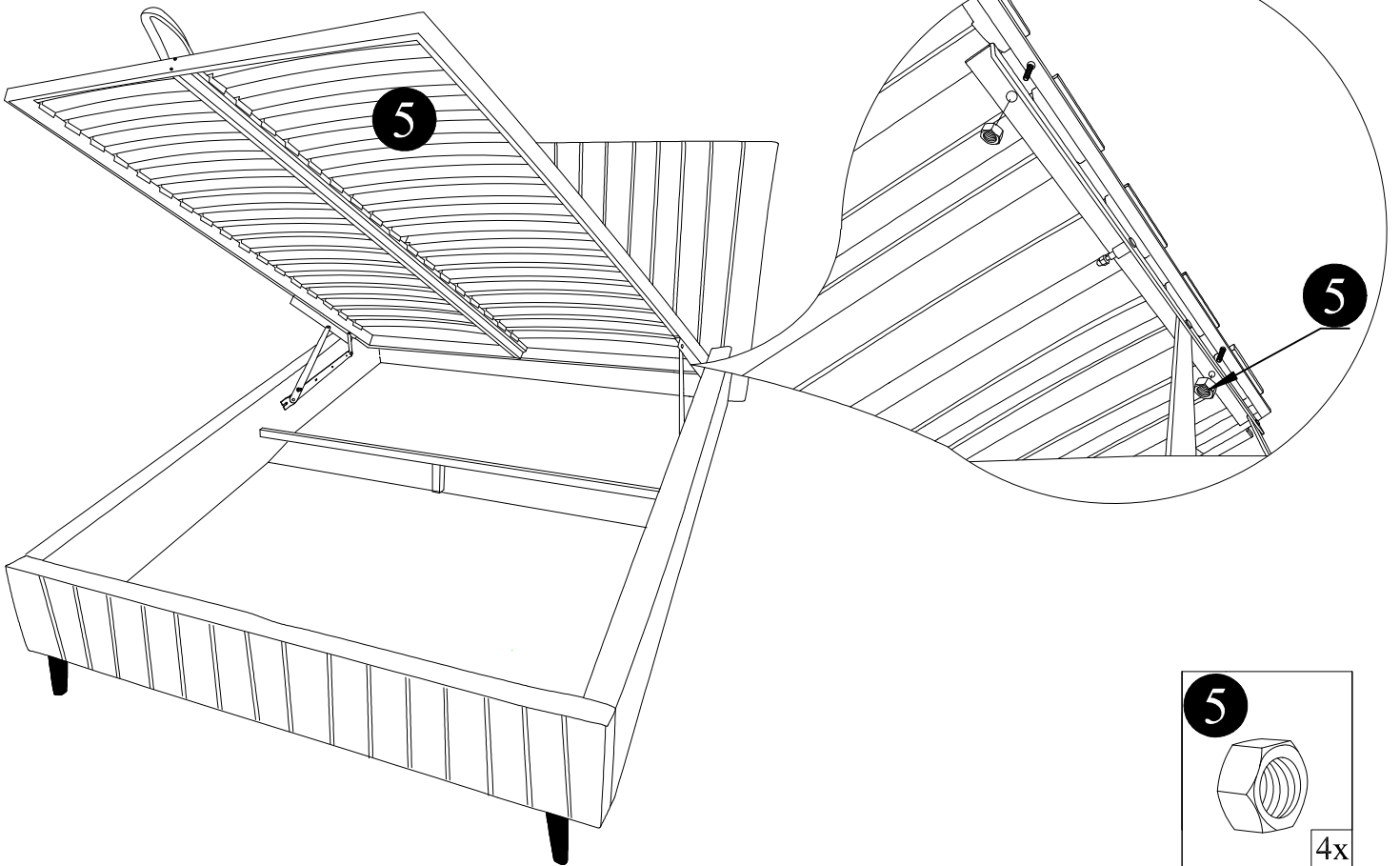
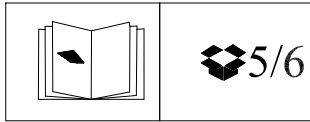

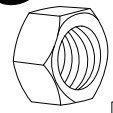
<b>5</b>  4x M8
---