

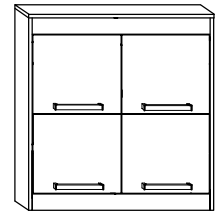

MXS-41 SZAFKA WISZĄCA 4D

→ 80 + 85 × 31



x 7



x 18



x 3



x 21



x 3 kpl.

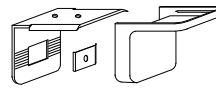

(a)

(b)

(c)

(d)

(e)

x 8



x 8

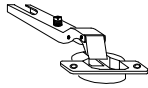

x 4



(f)

(g)

(h)

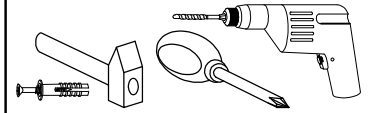

x 16
(3,5x16)



x 6
(6,2x13)



x 8



x 50

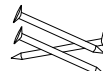

(i)

(j)

(k)

(l)

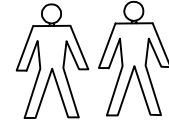

40 min



1 - FAZY MONTAŻU

A - OZNACZENIE ELEMENTÓW

a - OZNACZENIE AKCESORIÓW

1

x 3



x 6



x 3

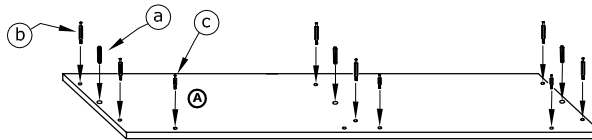

2

x 2



x 8



x 2



x 8



x 4



x 4

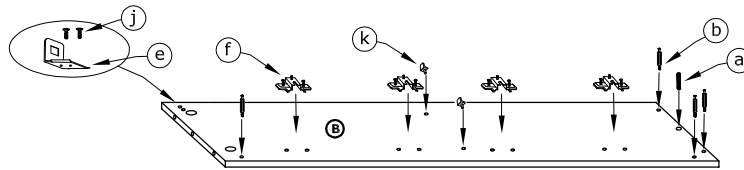

3

x 1



x 2



x 2

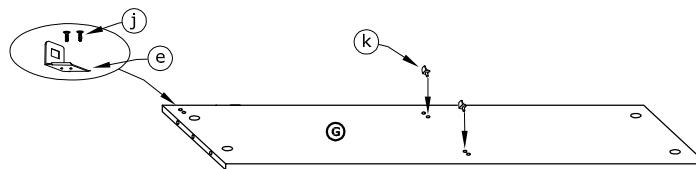

4

x 2





x 4

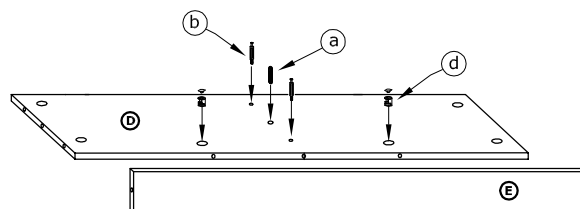
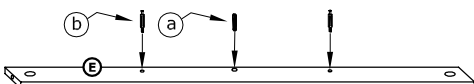

x 2



5

- x 10

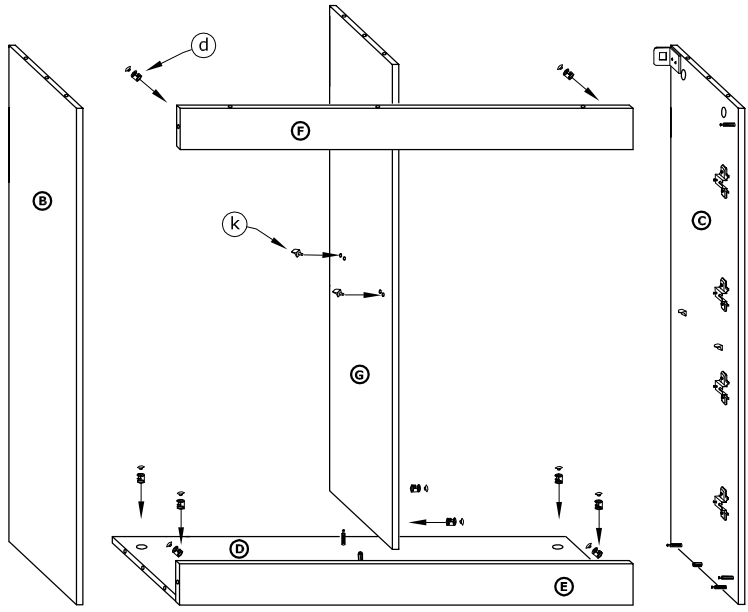
- x 2





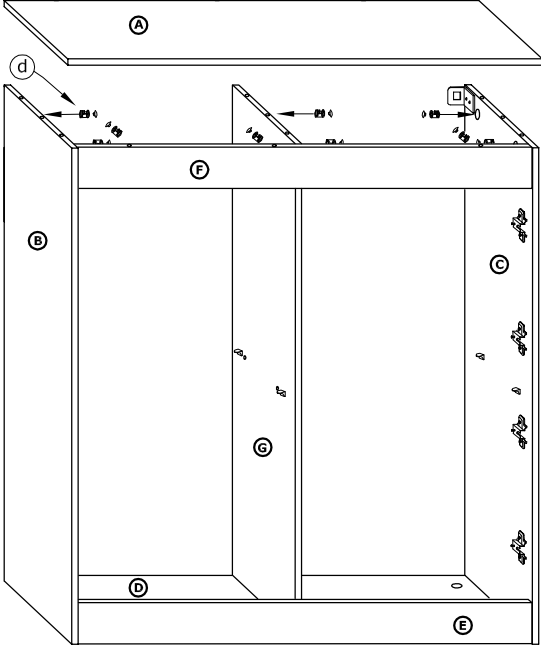

6

- x 9



7

- x 4

- x 4

- x 16
(3,5x16)

- x 50
