

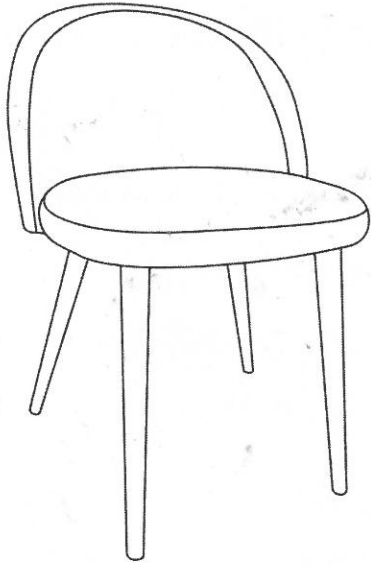



ASSEMBLY INSTRUCTION



Ax1 	Bx12 	Cx12 
Dx4 