

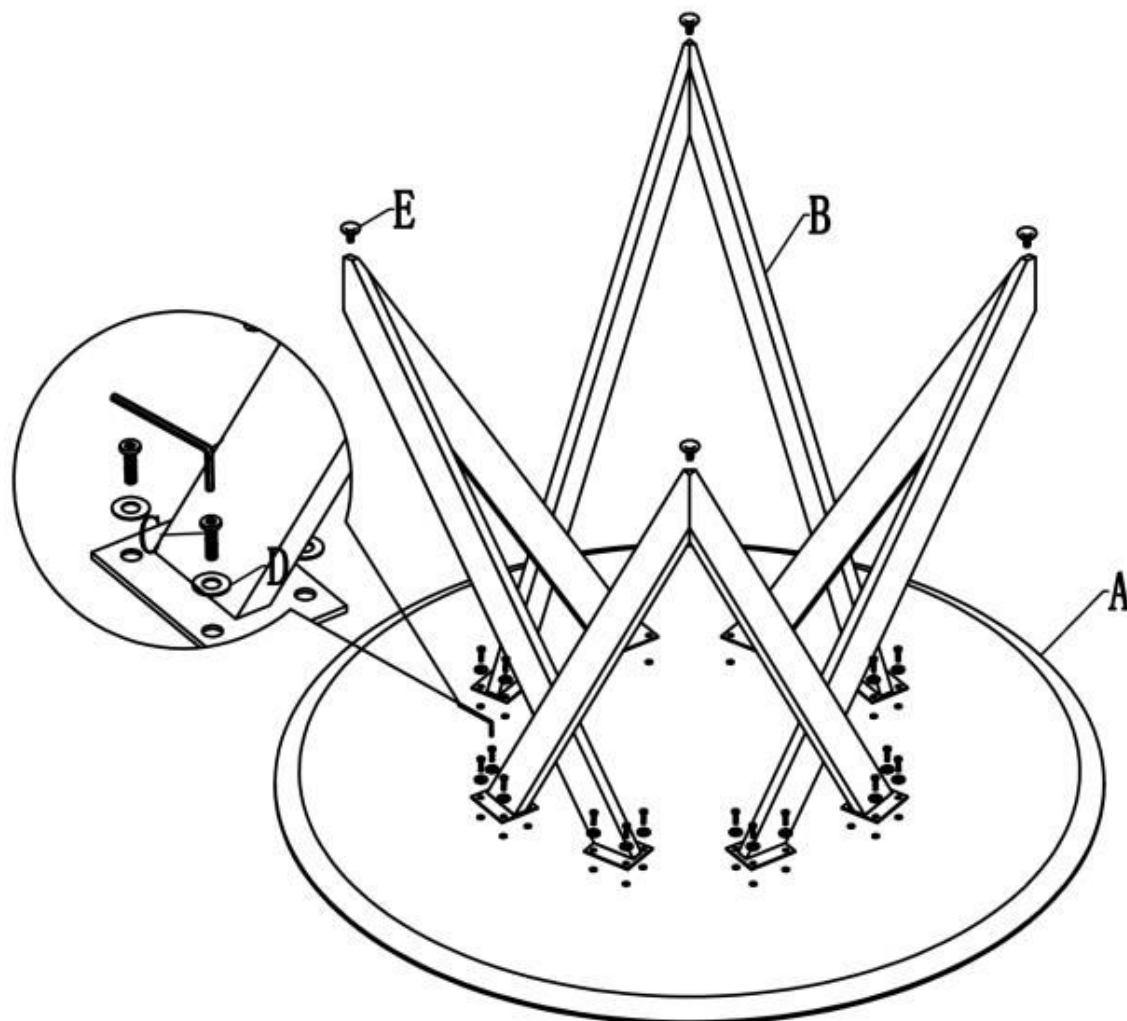







# GUSTIMO



A		1
B		4
C	 M8x25	32
D		32
E		4

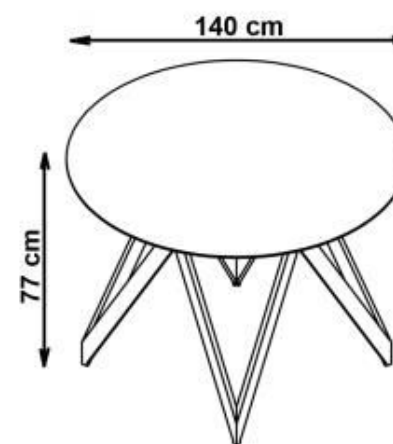

 max. 30 kg



v.1