

SZAFKA 250

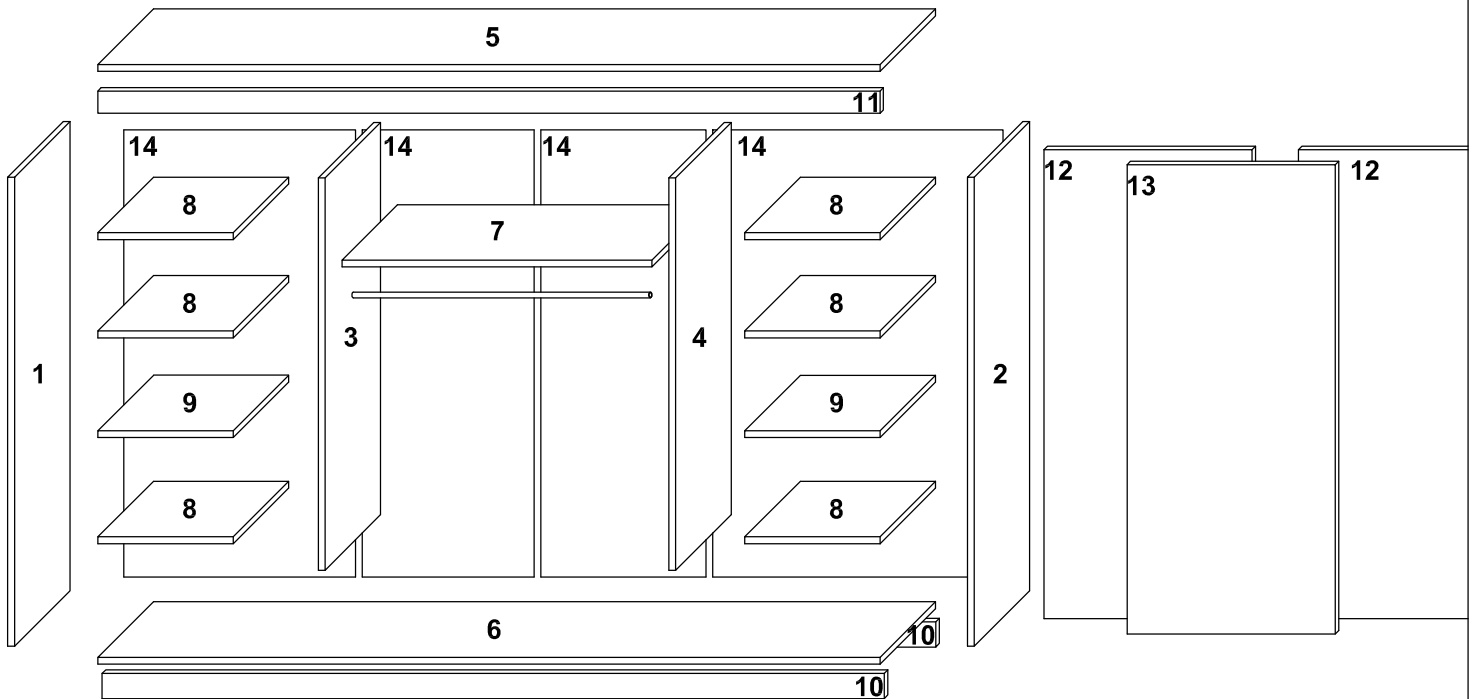

33 A	33 B	33 C	38 D	24 E	14 F	3 kpl N
2 G	W3,5x13	1 I	2 J	W4x30	L	M

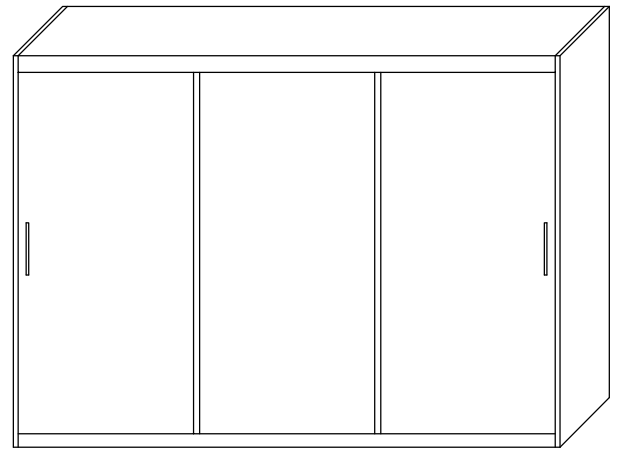
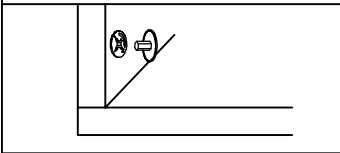
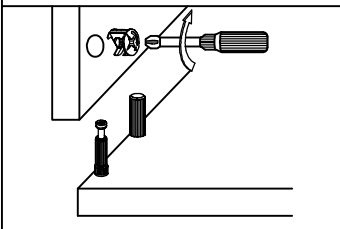
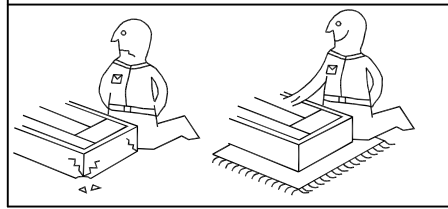
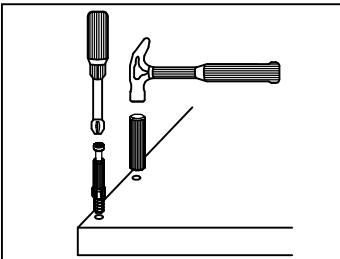
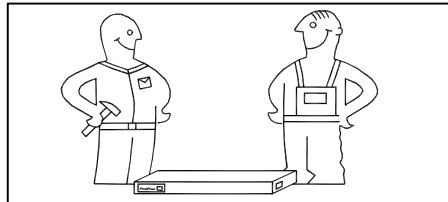
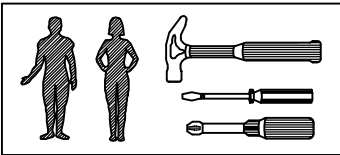
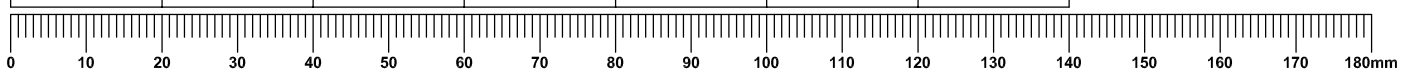

1

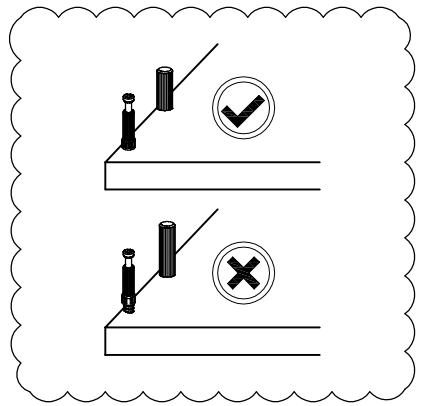
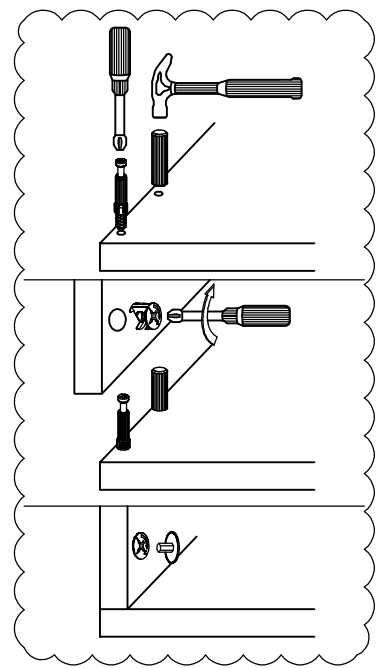
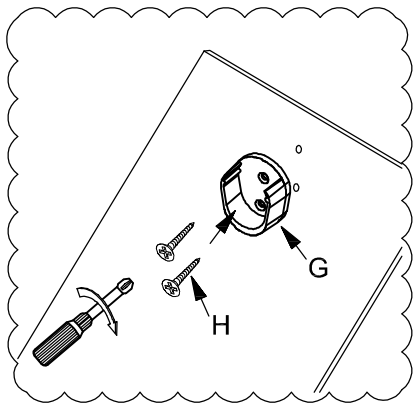
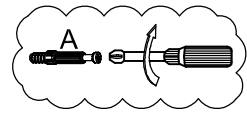
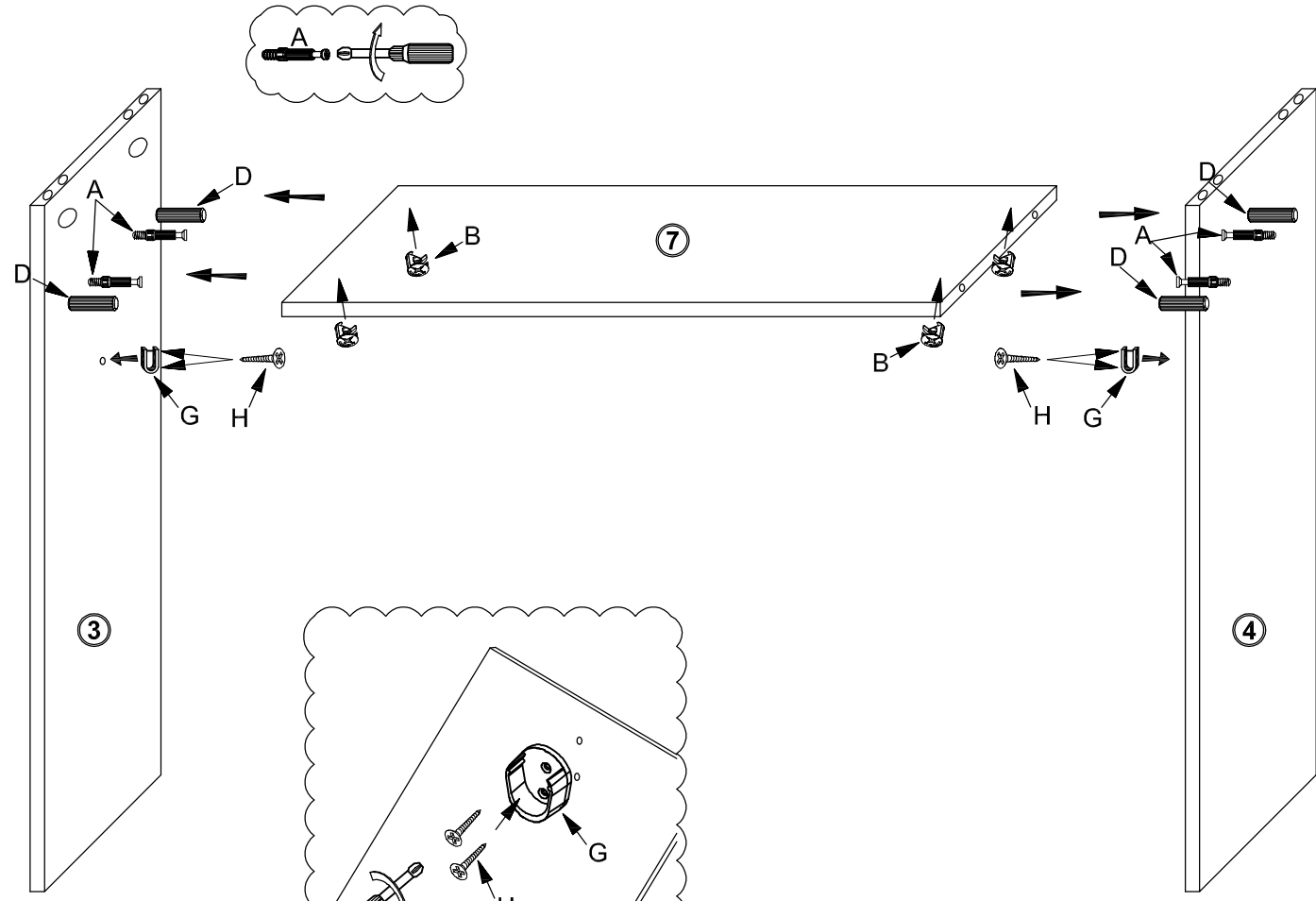



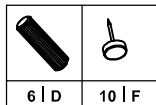
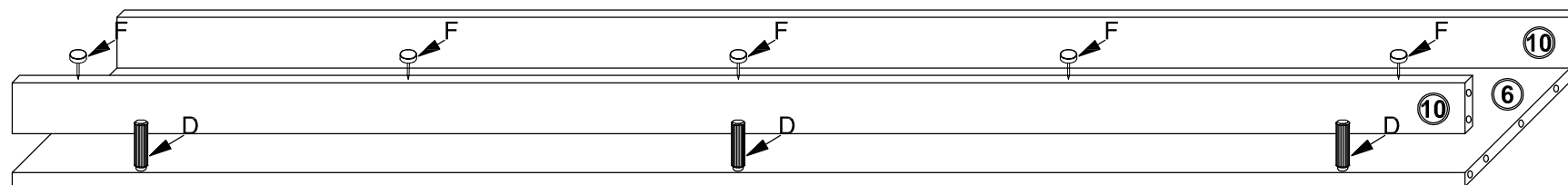
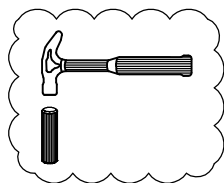
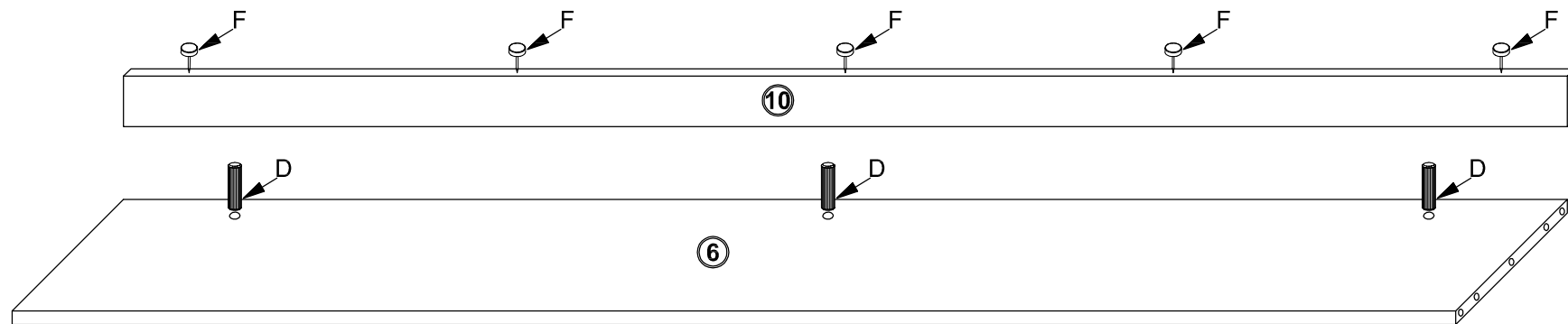

4 A	4 B	4 C	4 D	2 G	4 H

W3,5x13

2



3

			
12 A	12 B	12 C	8 D

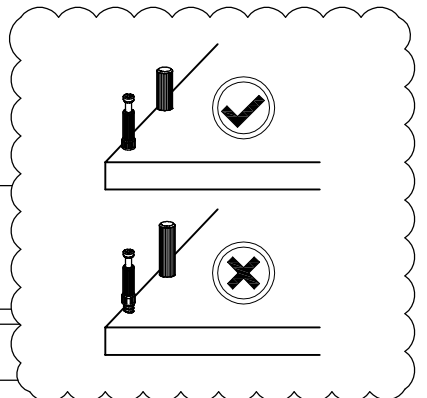
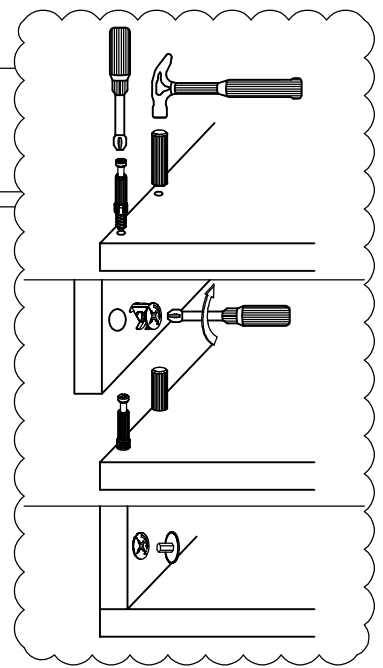
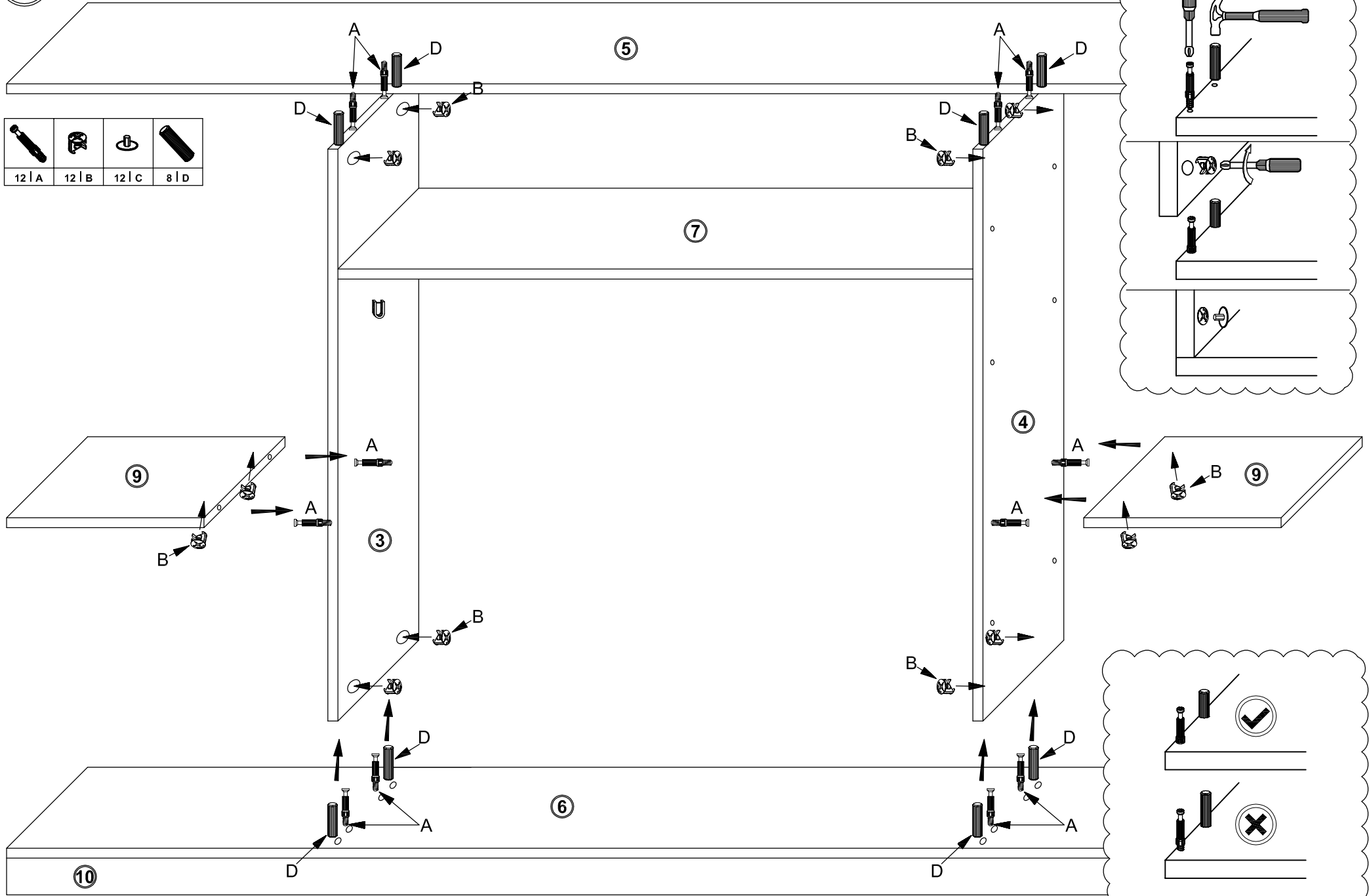

4

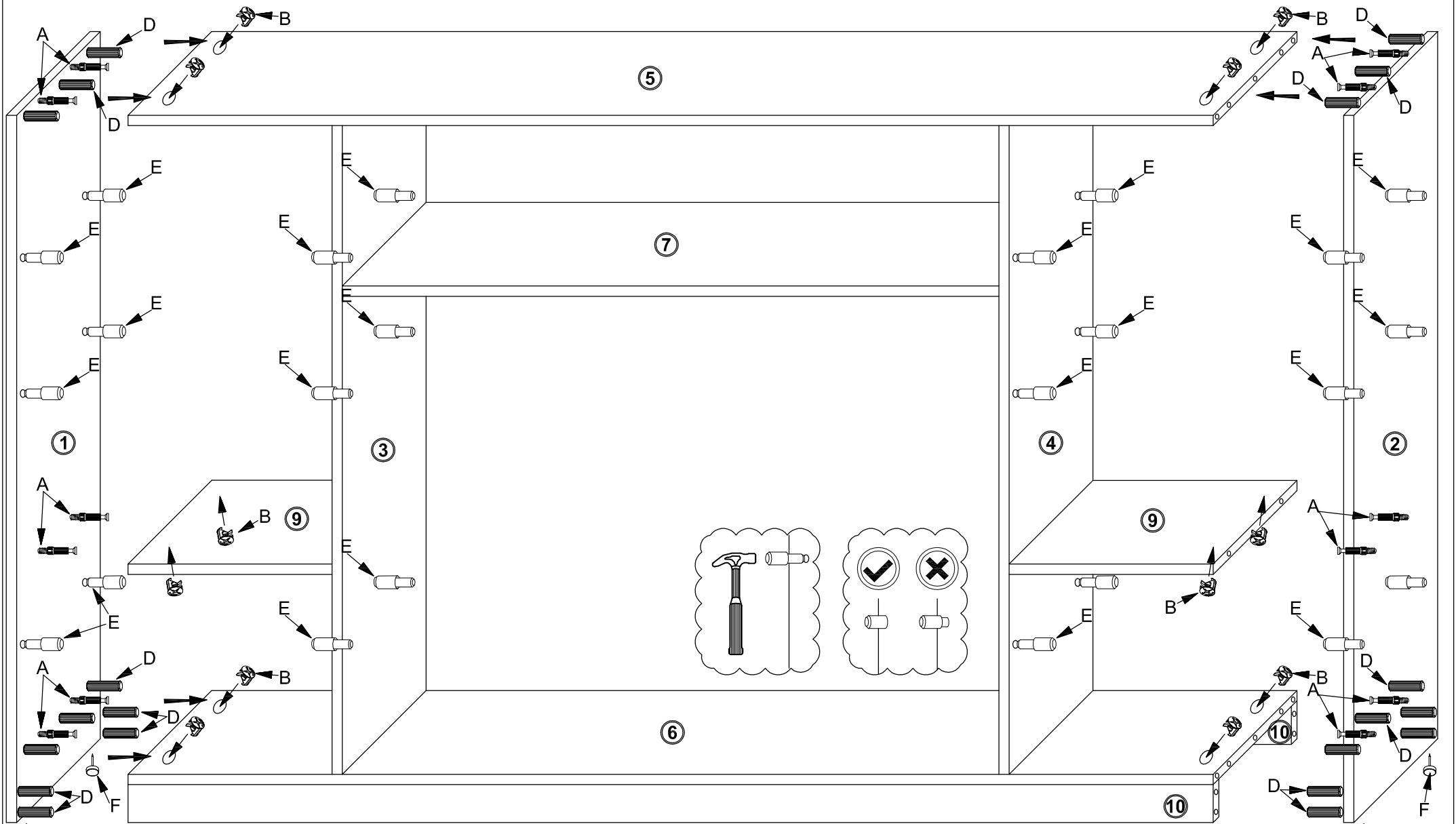

12 A	12 B	12 C	20 D	24 E	4 F

5

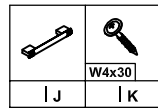
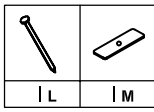
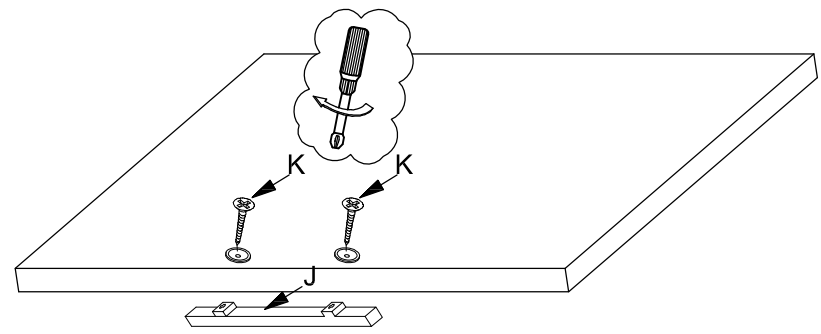
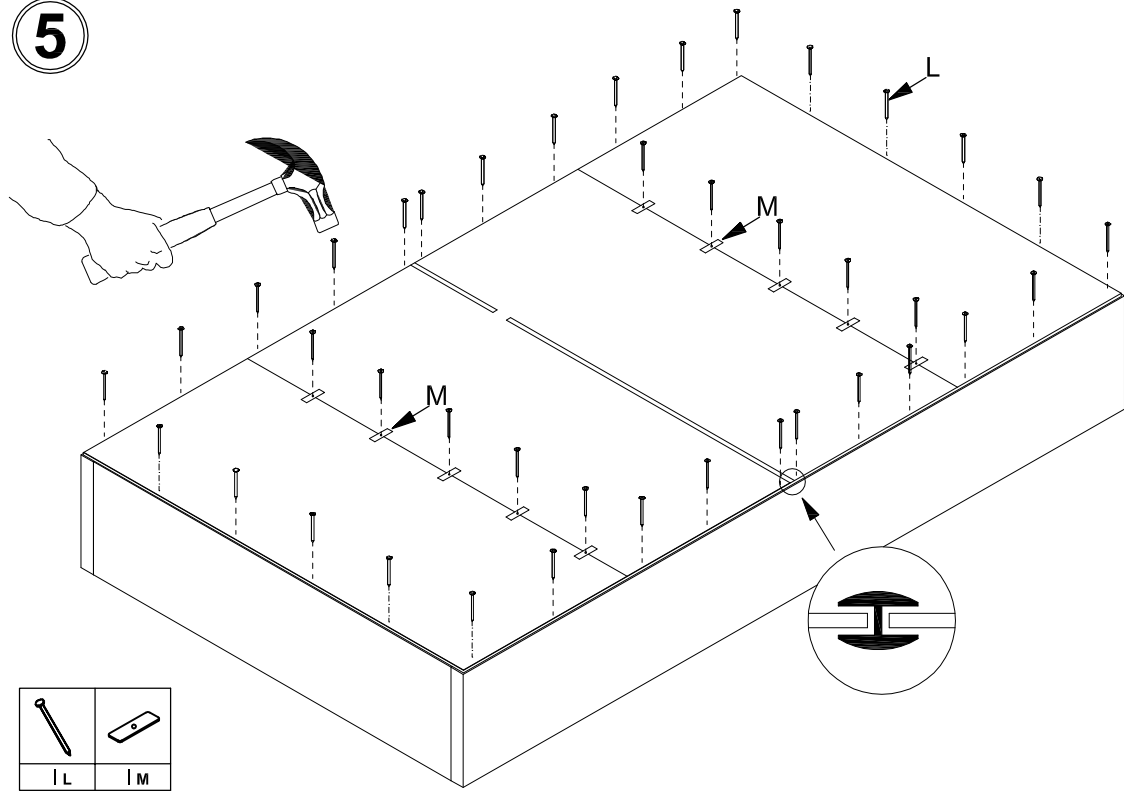

6

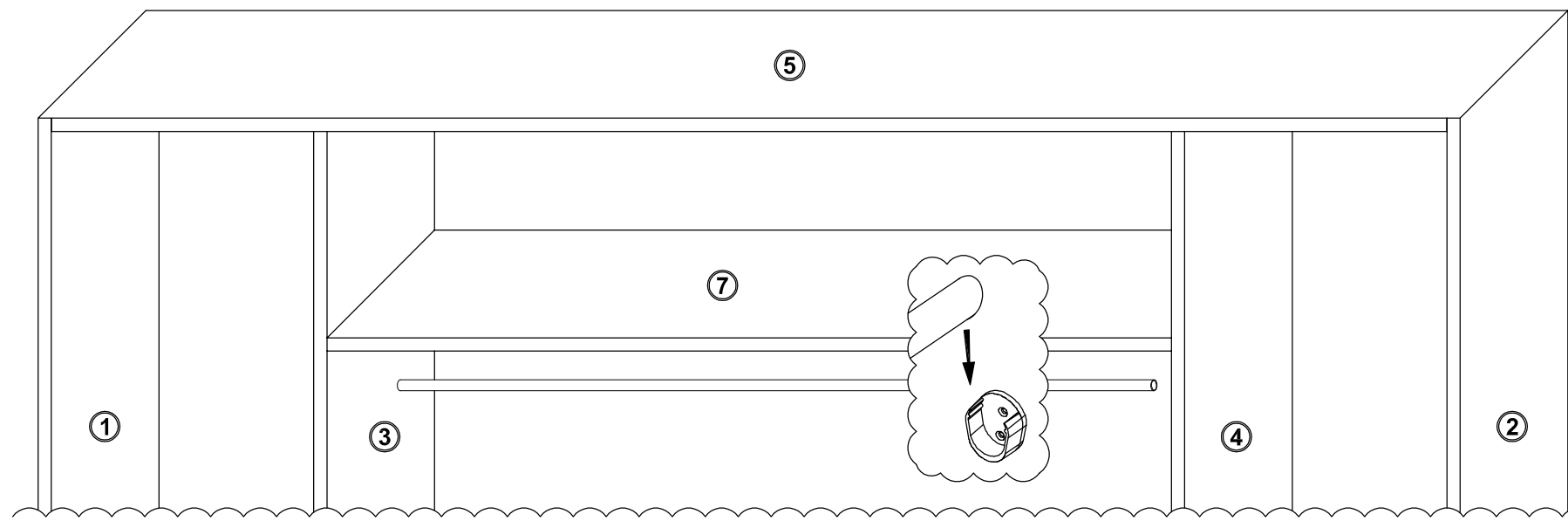

7

1

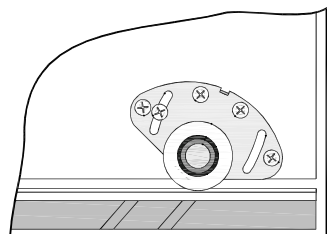
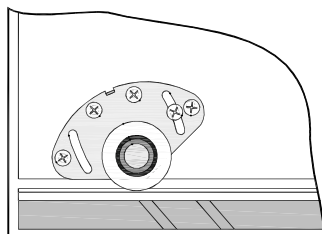
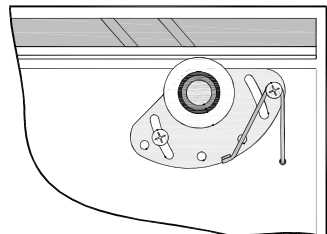
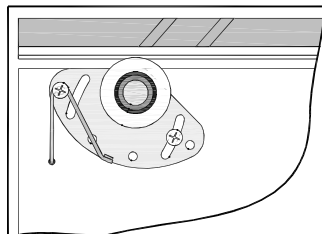
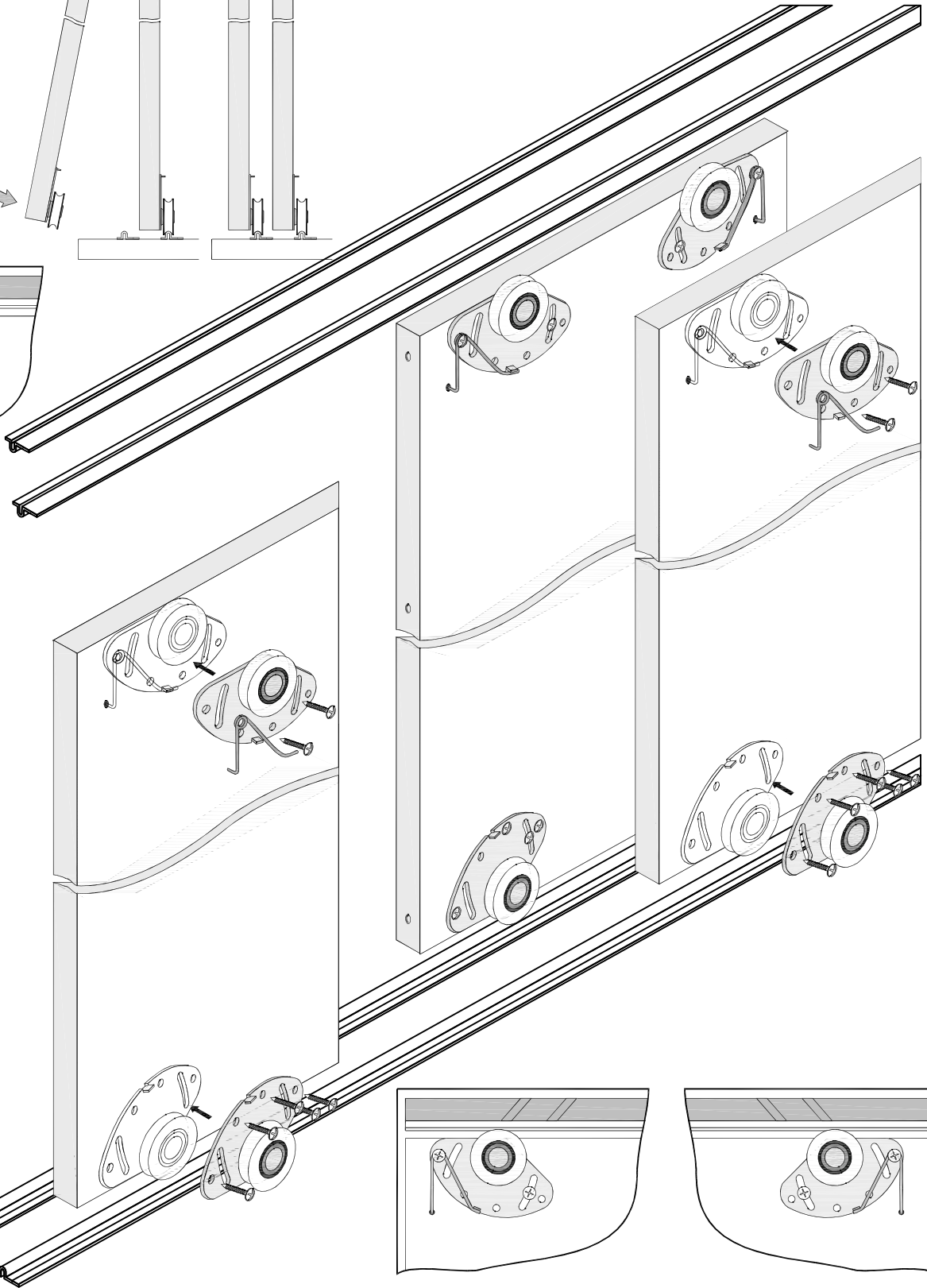
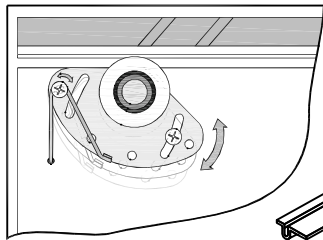
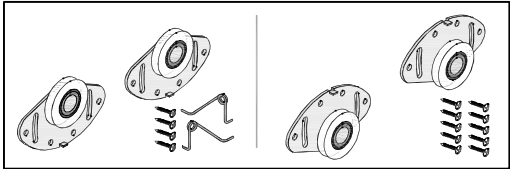

2

3

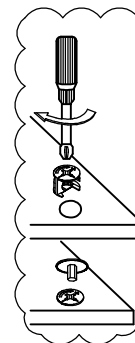
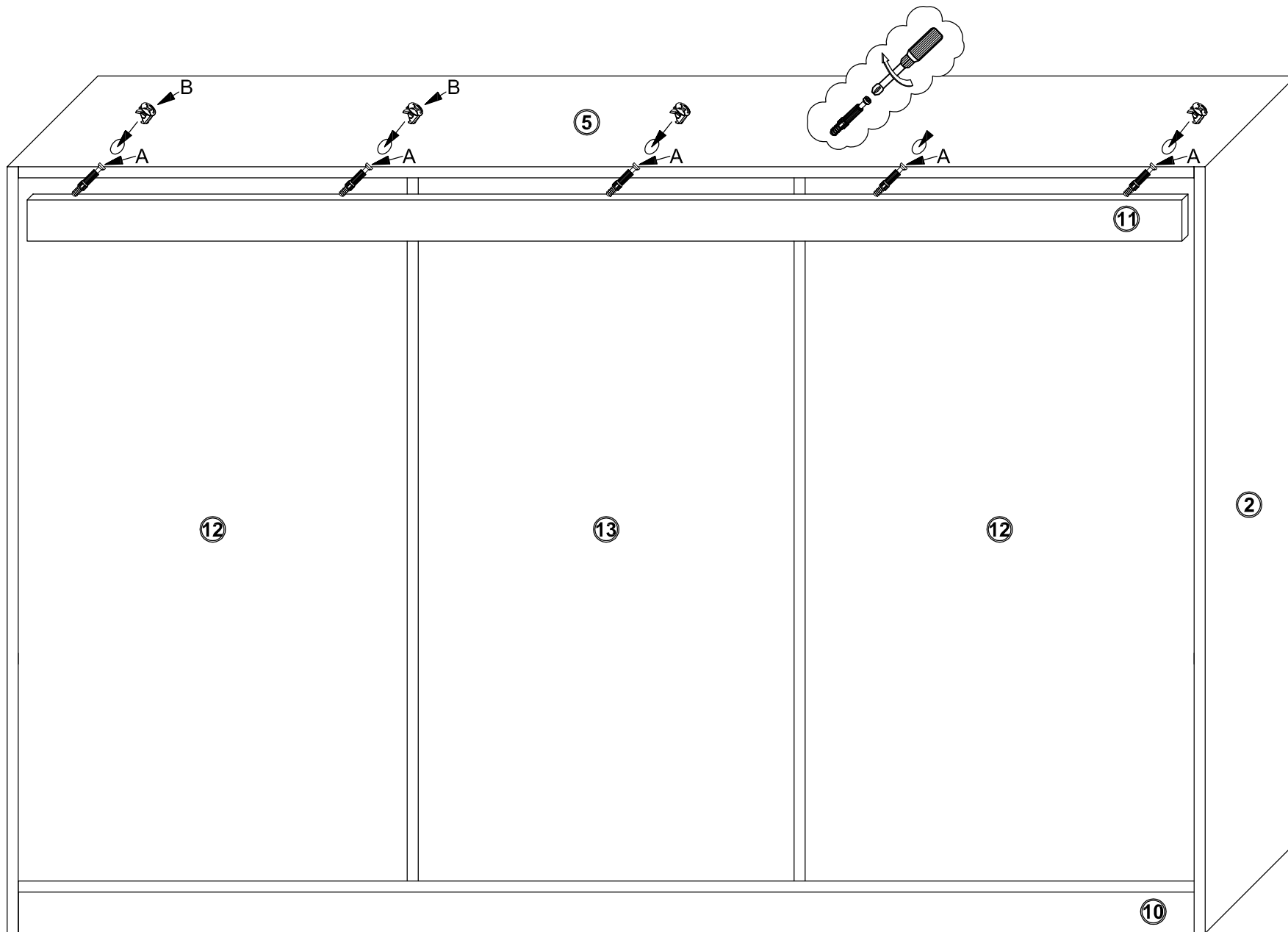

8



		
5 A	5 B	5 C