

120 min

TYP 610

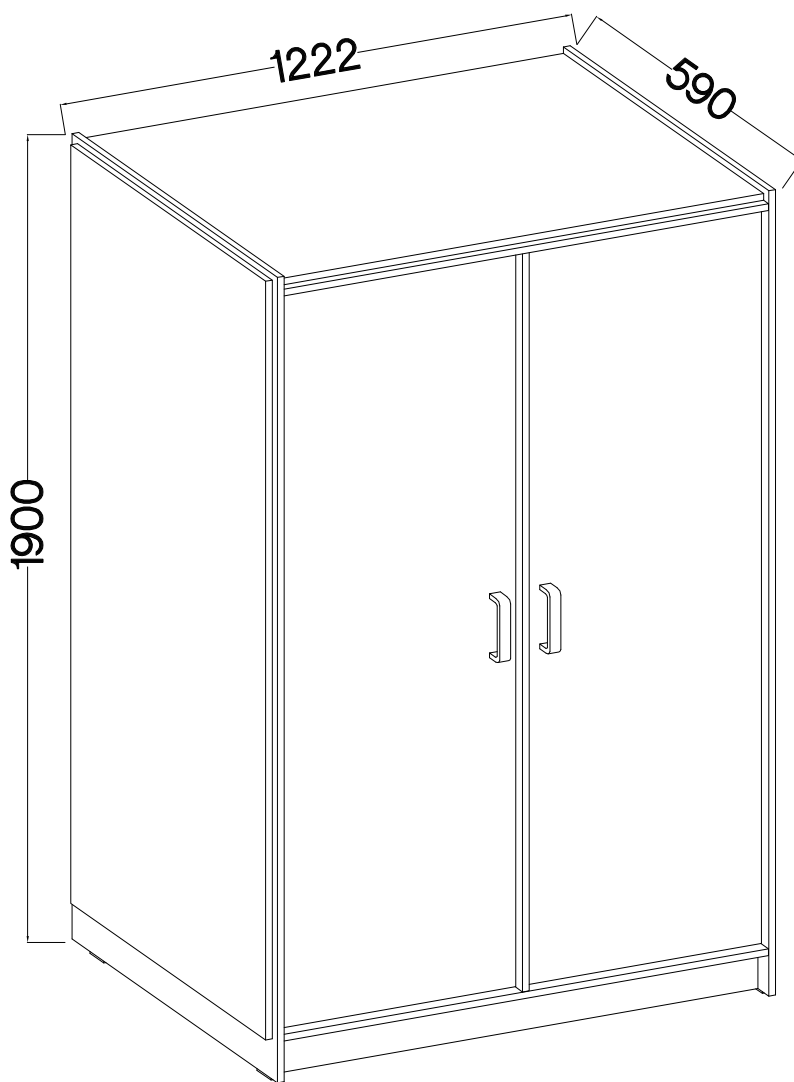
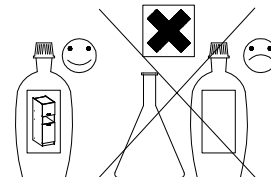

 +8x30mm A 28	 +8x60mm A2 2	 +8x20mm A4 8	 6,4 x 50mm B 3	 +15/12mm C 30	 L=20mm D2 24	 L=56mm D4 3					
 cza. E 16	 art. E 8	 6.5x48x16 F2 4	 +15x5mm F4 2	 +35/16mm HG2 8	 L=563mm J2 2	 +5/16mm J3 12	 J17 4	 L 16	 L2 12	 75x30x15mm L19 1	
 O 1	 +10x50mm O7 1	 +4.0x16mm P1 4	 +3.5x13mm P5 18	 +3.0x20mm P7 28	 +5.0x60mm P12 1	 +3.5x25mm BLACK P25 24	 +3.0x10mm P30 4	 L=128mm S 2	 T3 2	 M4x22mm U 4	

ISM-KIA-007

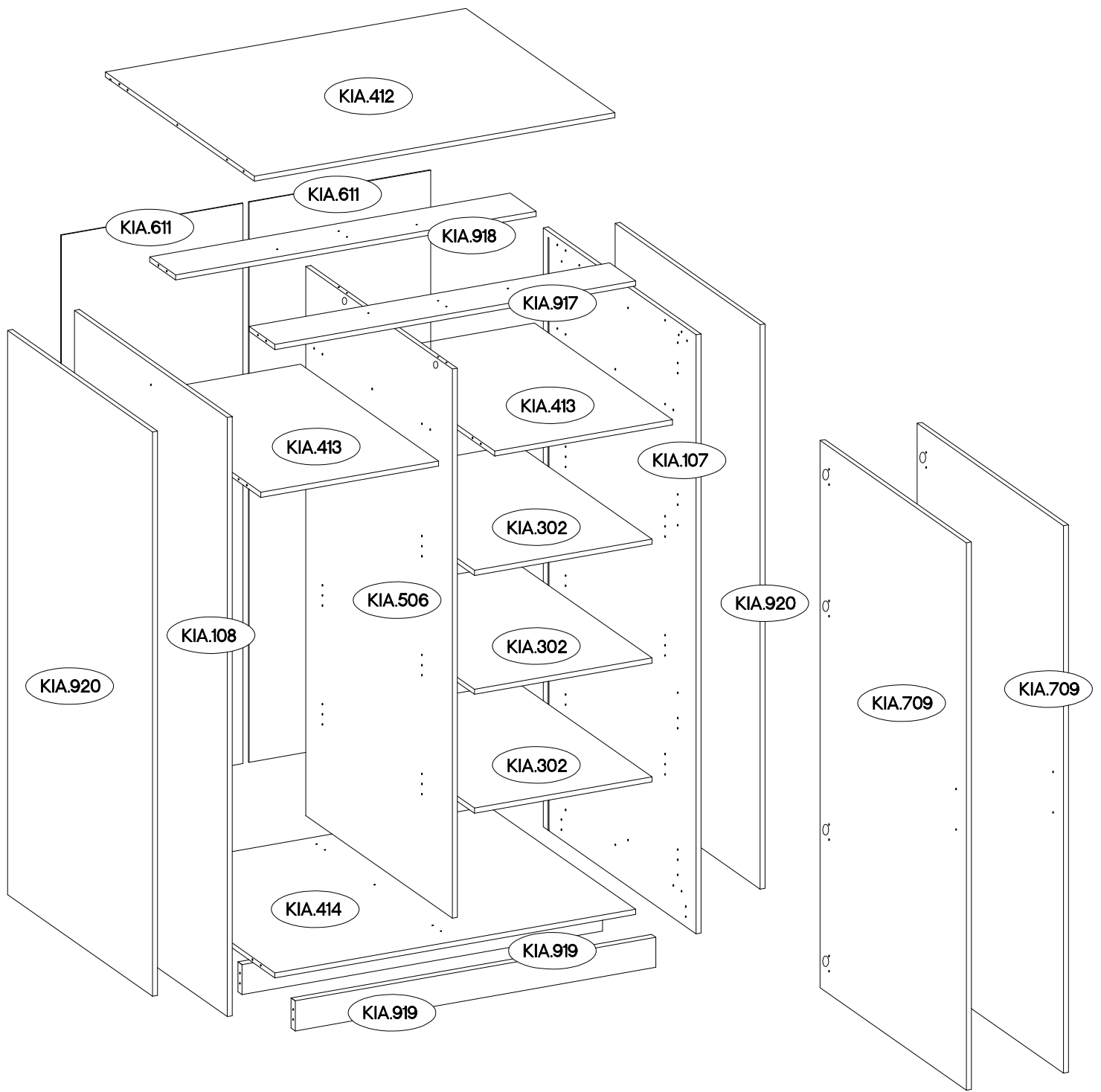





Colli	Ersatzteil Nummer	Dimension
1/4	KIA.302 x3	570x520x16
	KIA.412	1158x575x16
	KIA.414	1158x567x16
	KIA.413	571x534x16

Colli	Ersatzteil Nummer	Dimension
3/4	KIA.107	1895x590x16
	KIA.108	1895x590x16
	KIA.611 x2	1772x583x2,5





Colli	Ersatzteil Nummer	Dimension
2/4	KIA.413	571x534x16
	KIA.917	1158x100x16
	KIA.918	1158x100x16
	KIA.919 x2	1158x95x16
4/4	KIA.920 x2	1785x560x16

Colli	Ersatzteil Nummer	Dimension
4/4	KIA.506	1737x566x16
	KIA.709 x2	1731x567x16

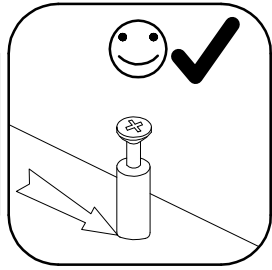
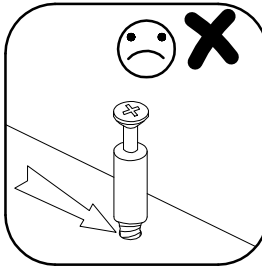
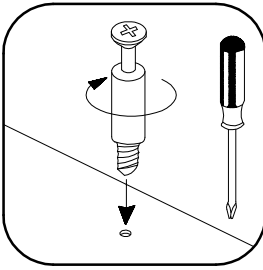
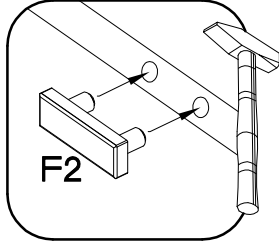
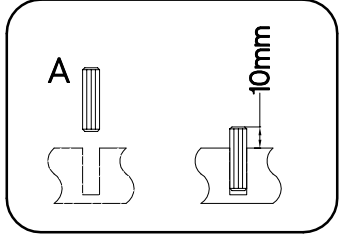
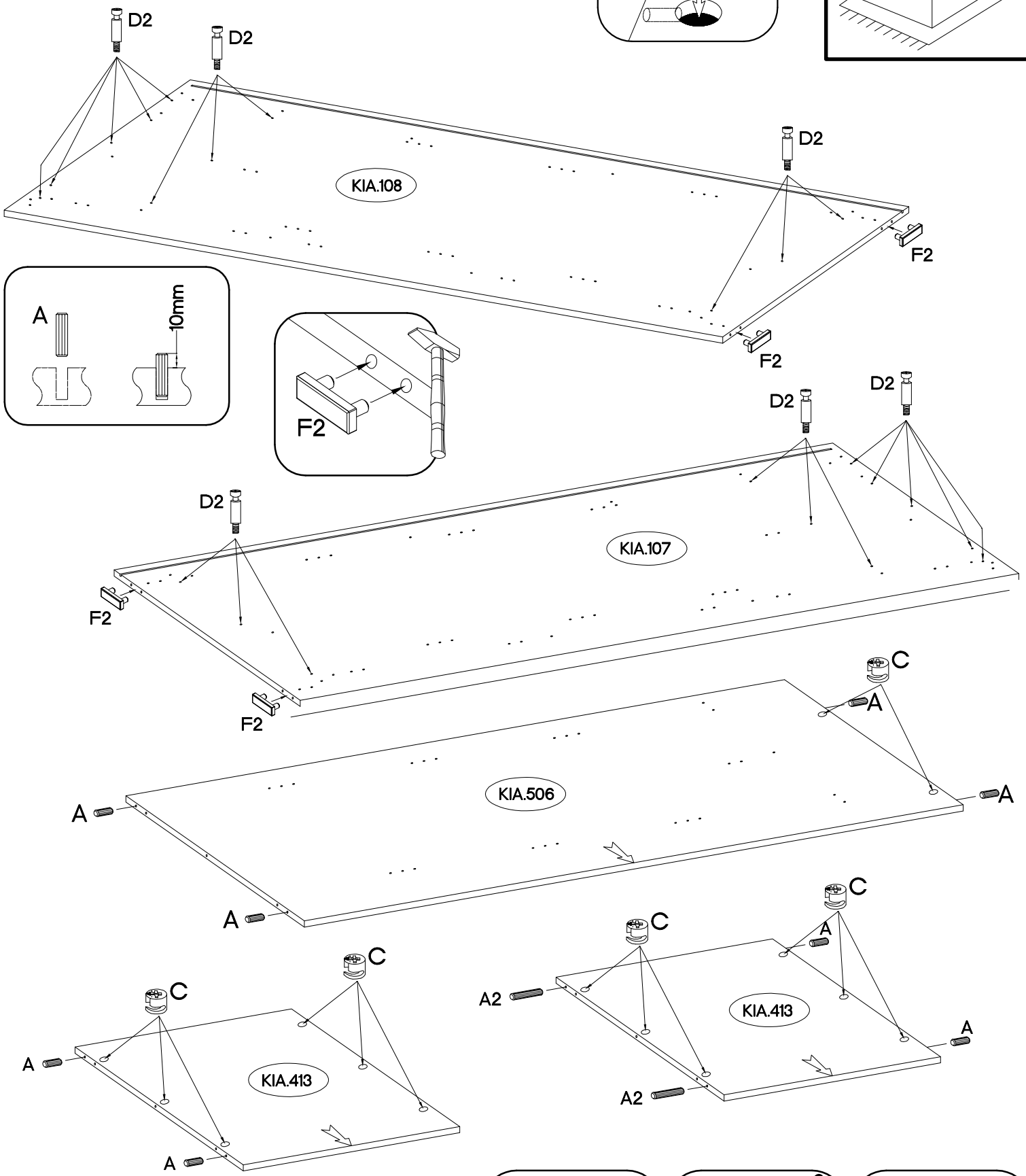
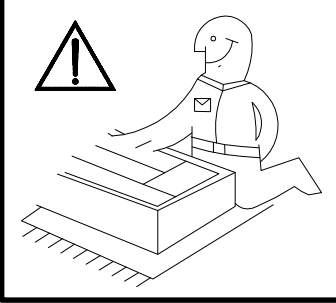
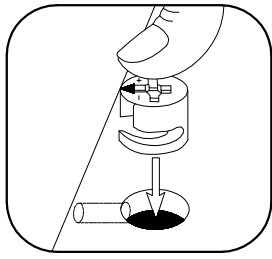

$\pm 8 \times 30 \text{mm}$  A 8	$\pm 8 \times 60 \text{mm}$  A2 2	L=20mm  D2 22	6.5x48x16  F2 4	$\pm 15/12 \text{mm}$  C 14
---	--	--	--	--

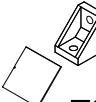

±8x30mm  A 20	L=20mm  D2 2	±15/12mm  C 16	 T3 2	±4.0x16mm  P1 2	±15x5mm  F4 2
--	---	---	---	--	--

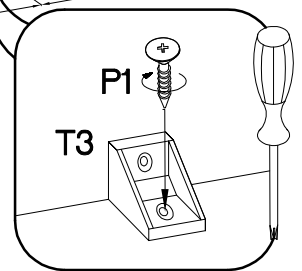
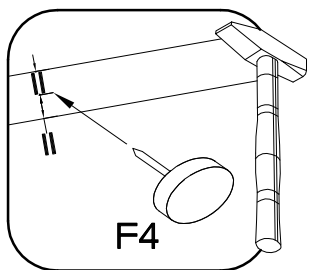
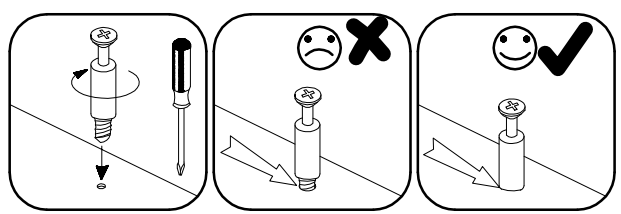
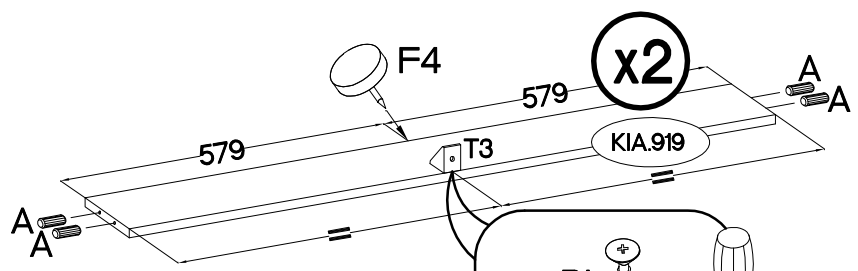
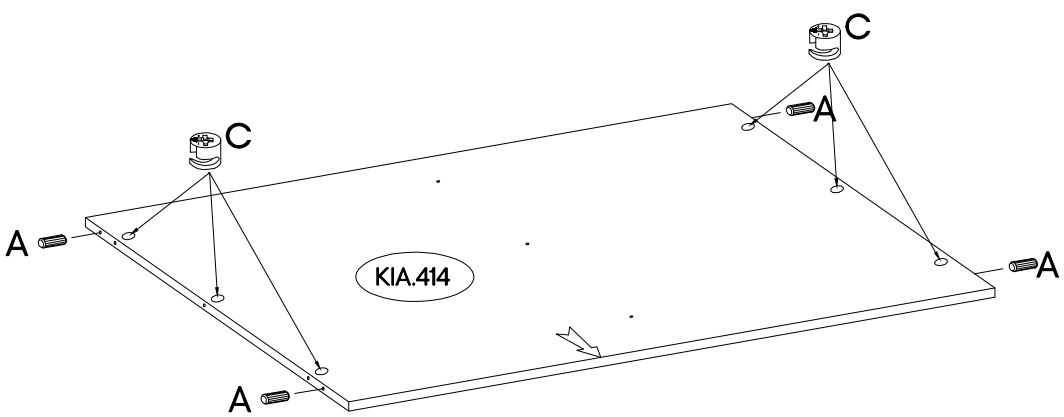
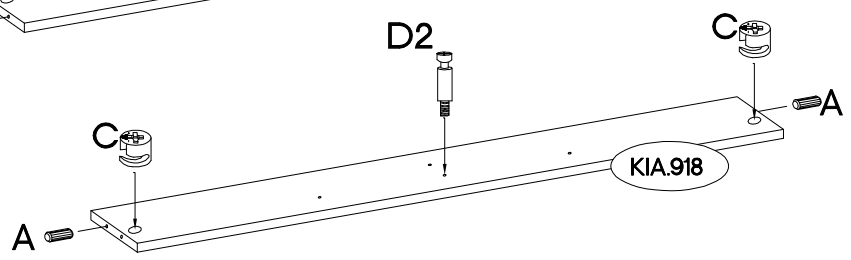
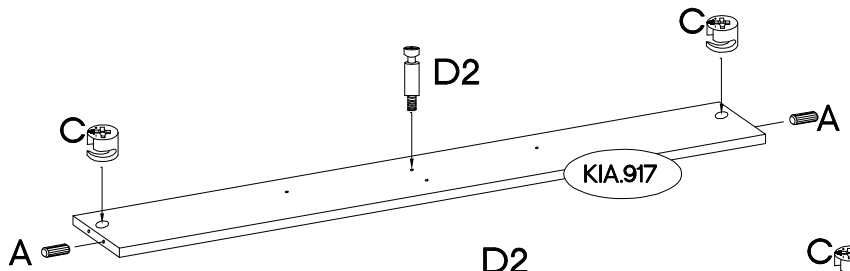
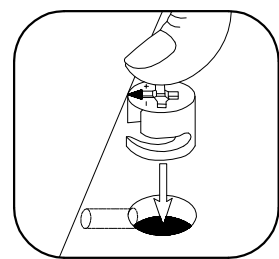
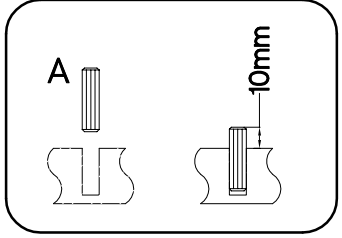
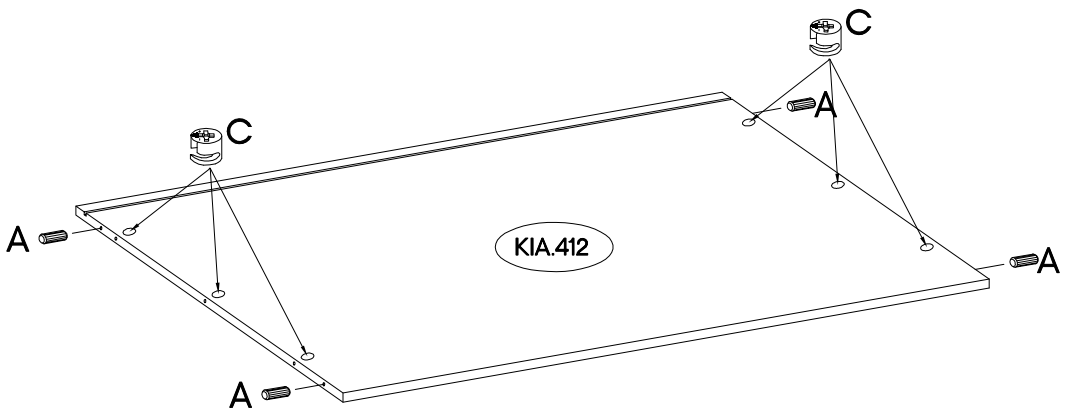
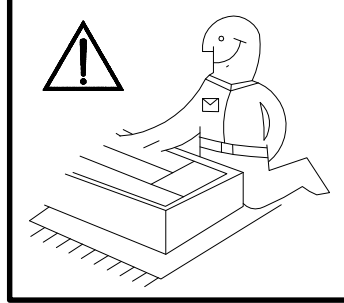

3

+8x20mm
A4
8

A4 20mm 10mm

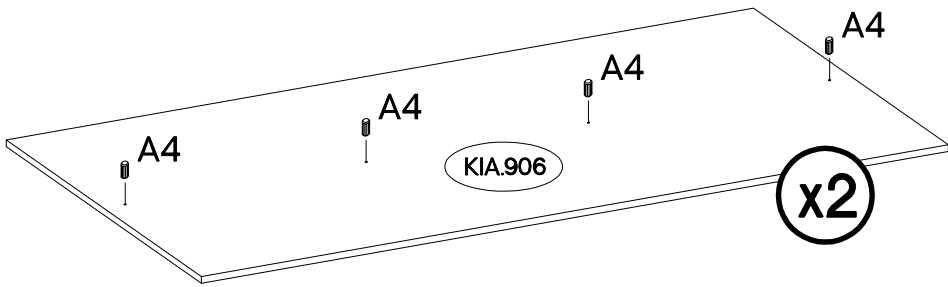
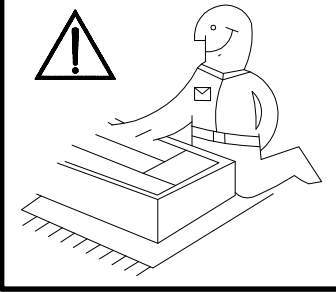

4

+3.5x25mm
BLACK
P25
20

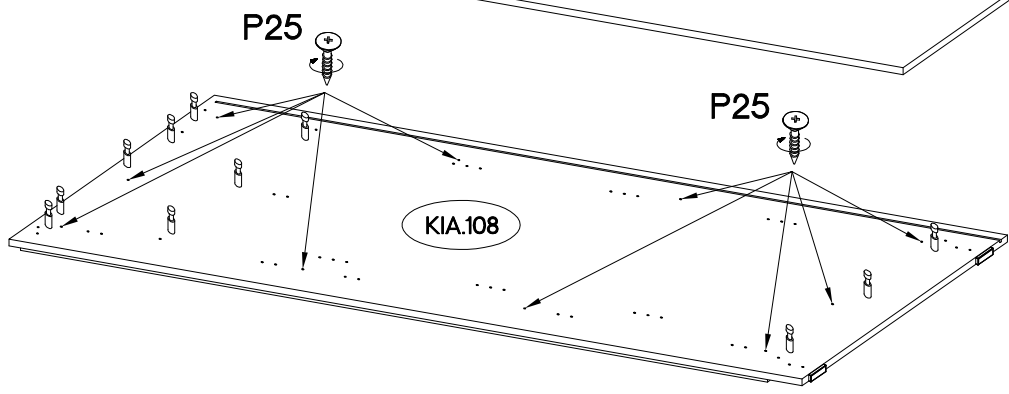
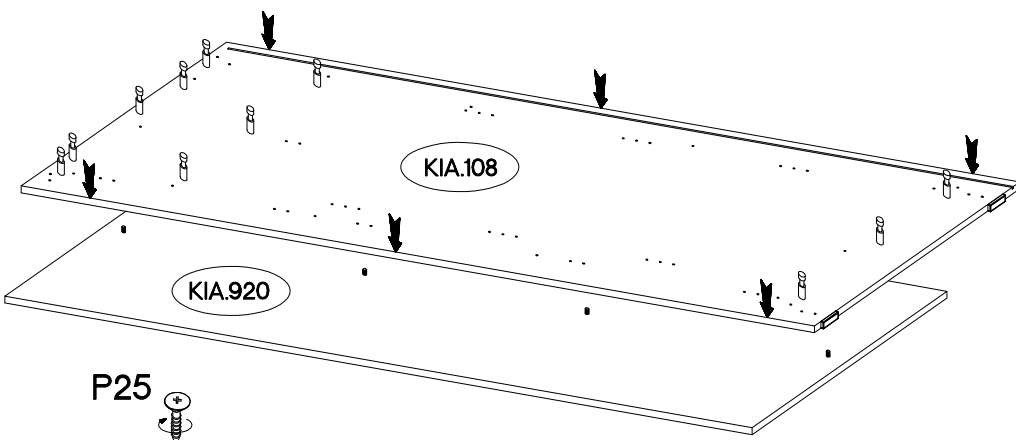
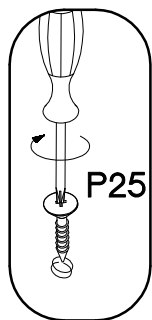
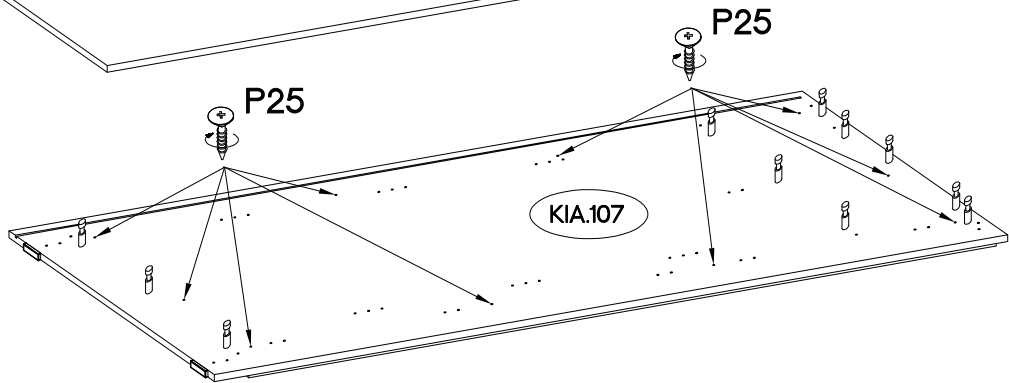
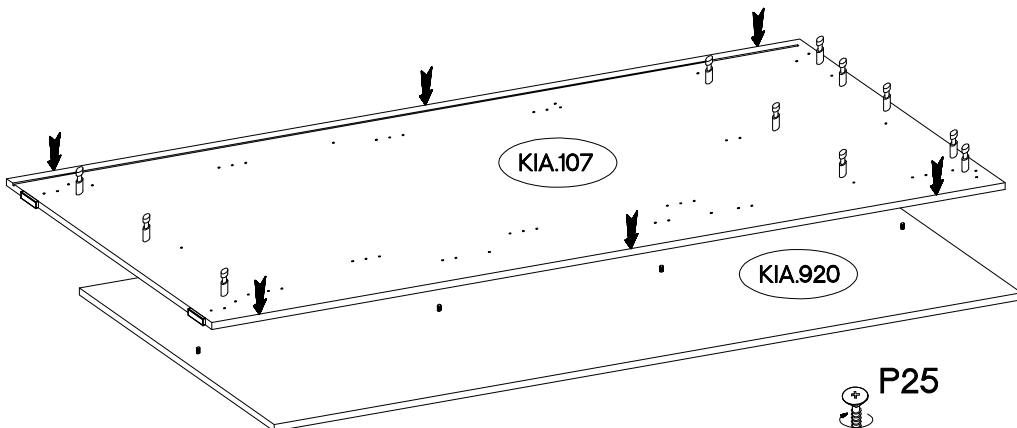

5

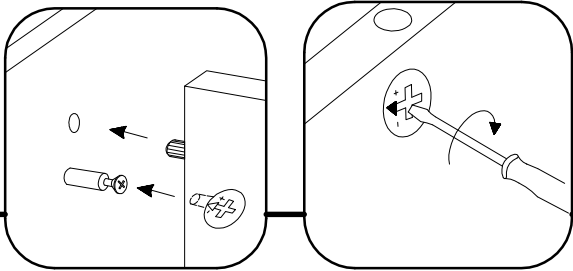
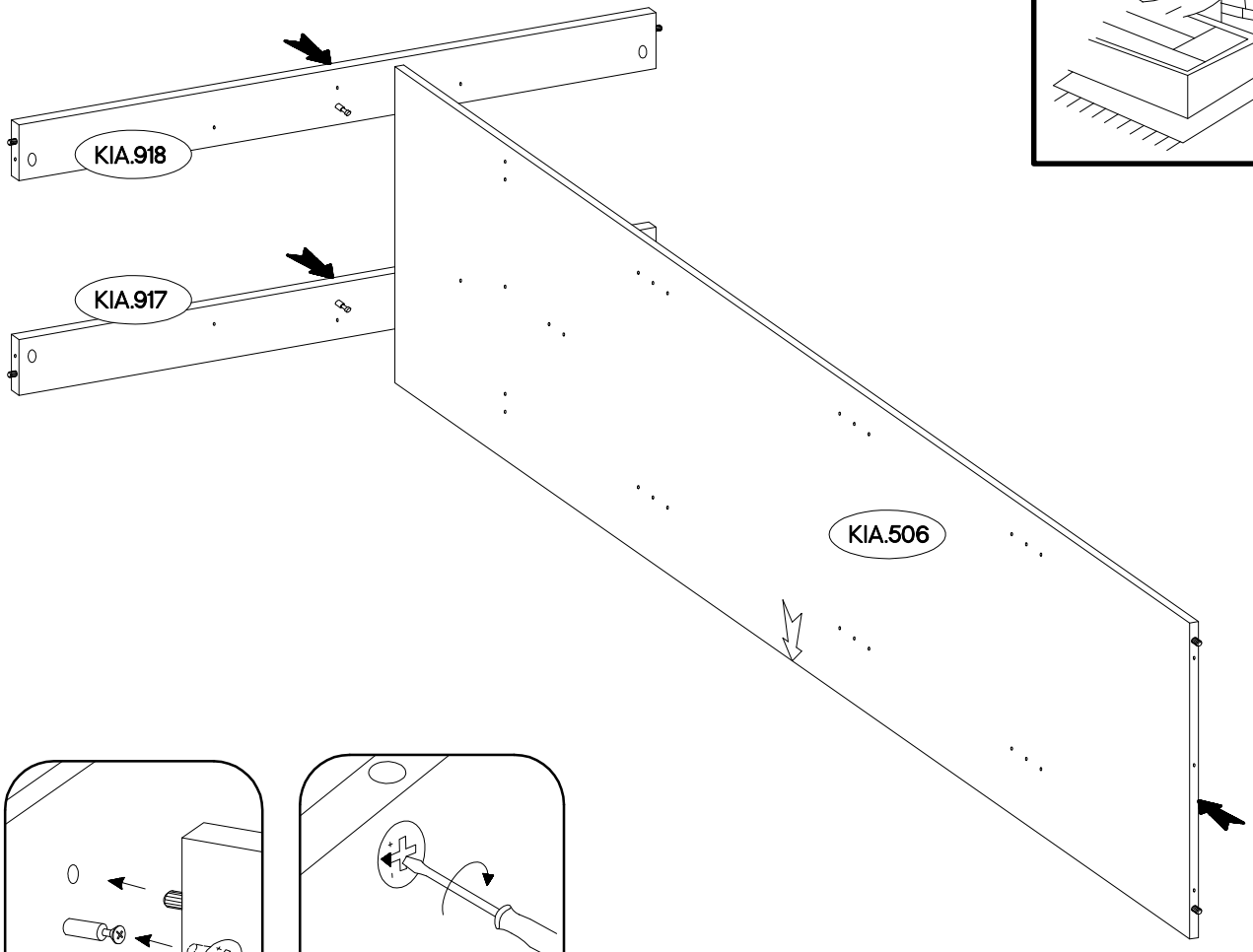
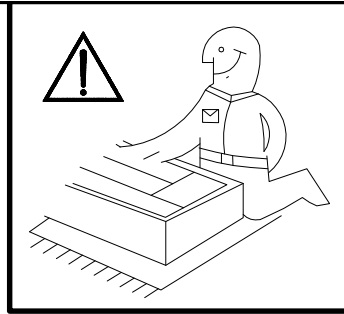

6

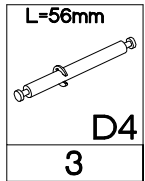
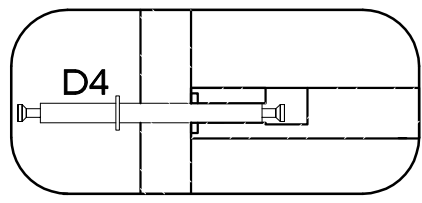
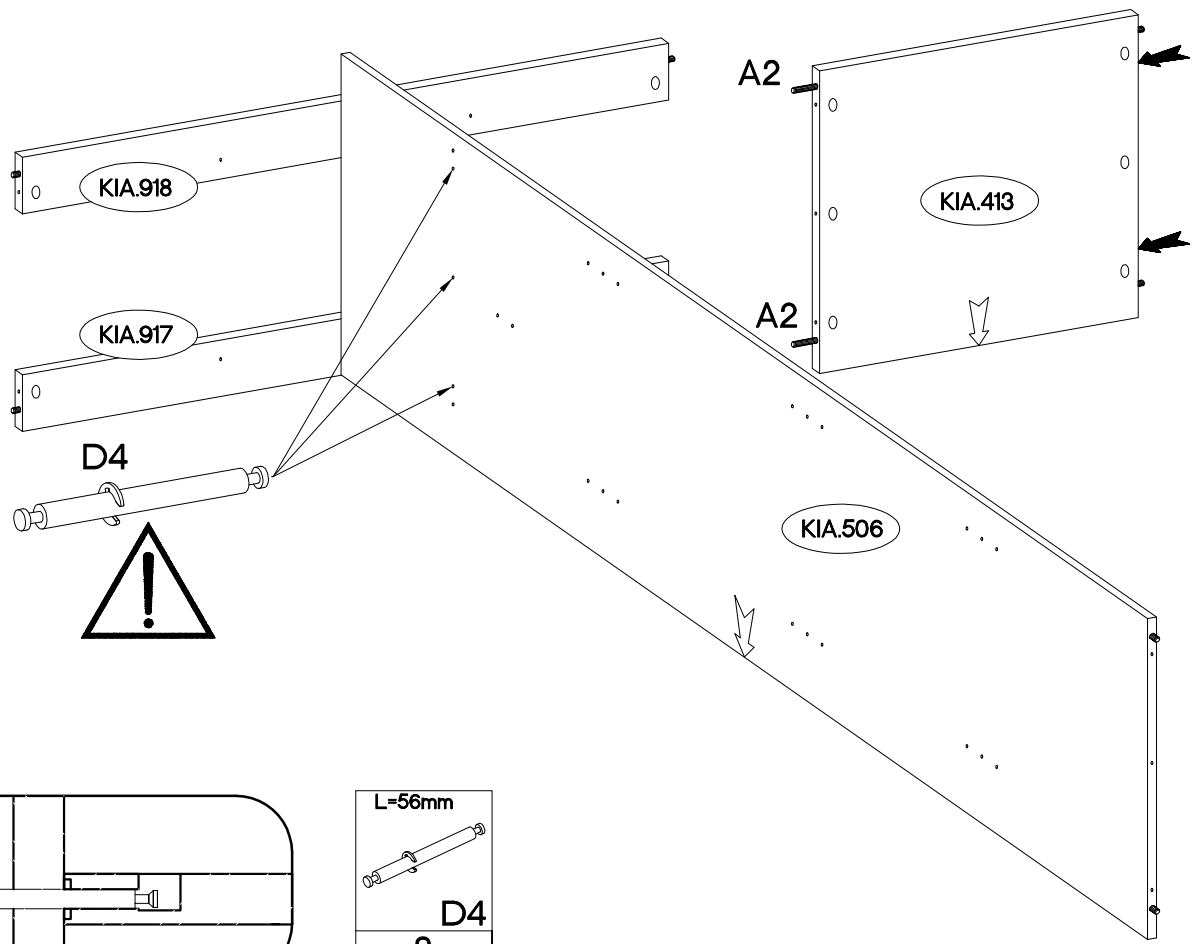

7

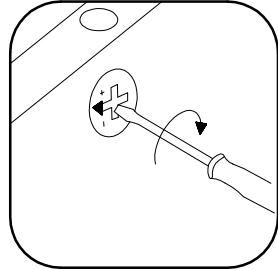
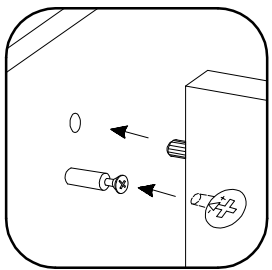
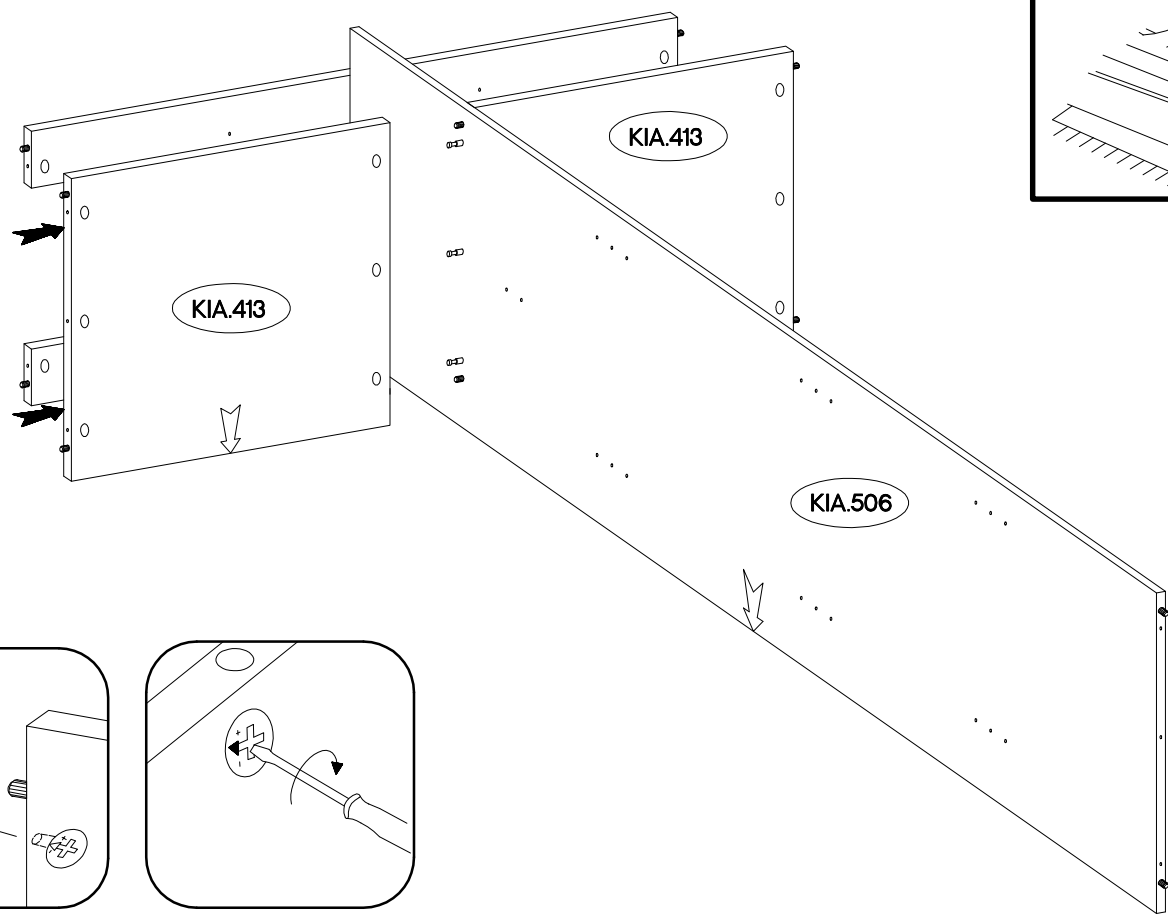
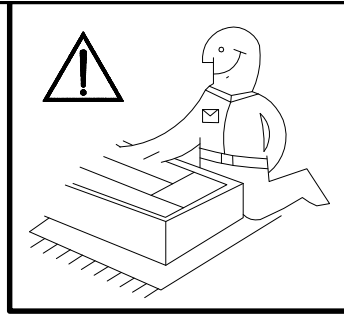

8

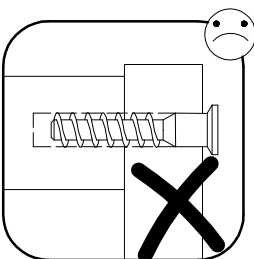
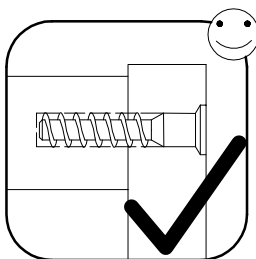
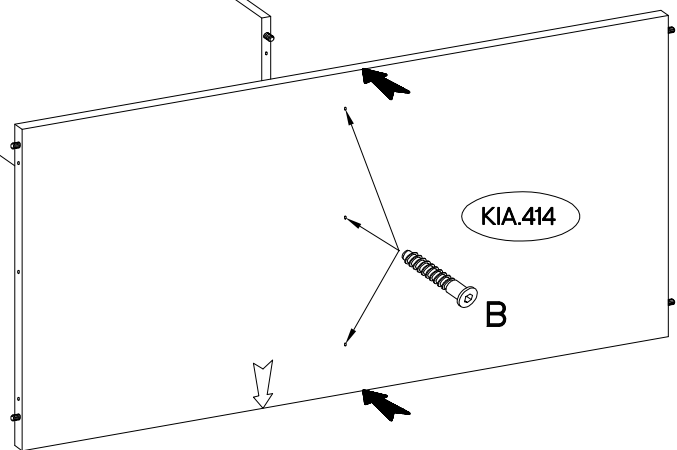
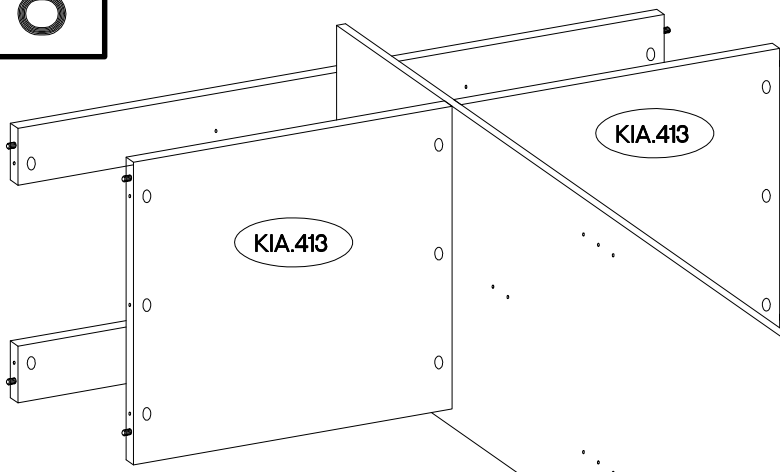
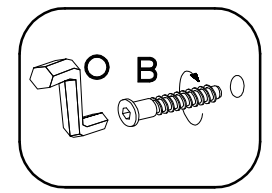
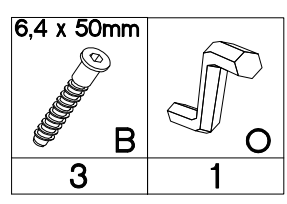

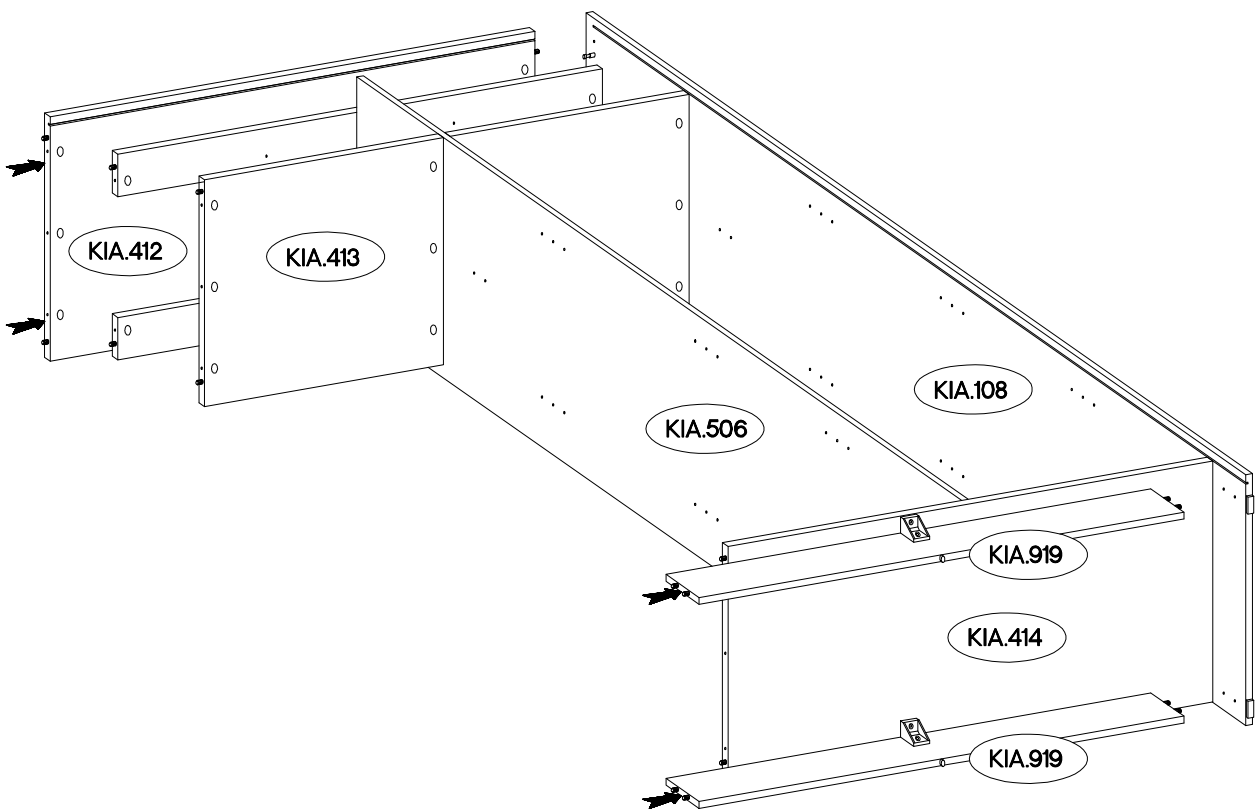
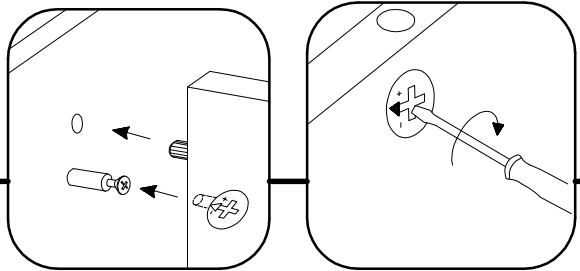
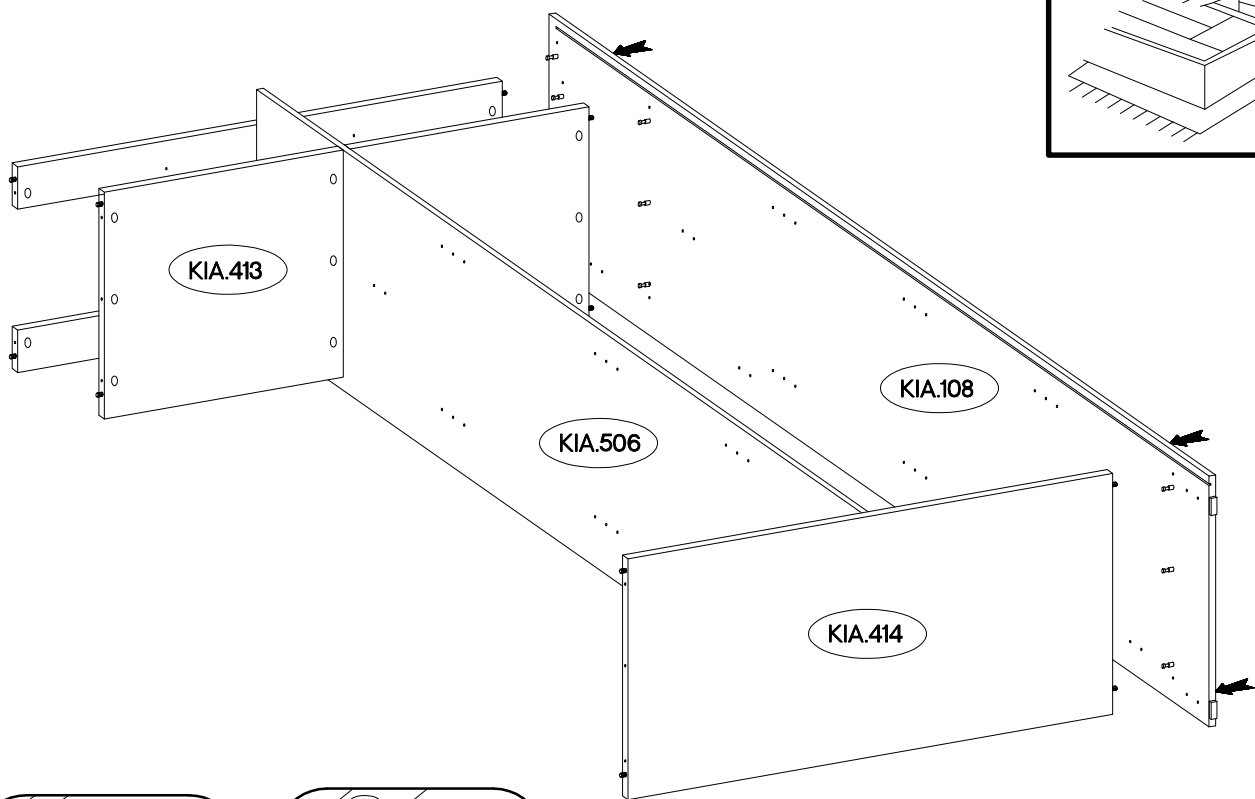
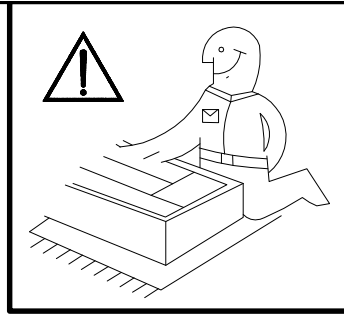



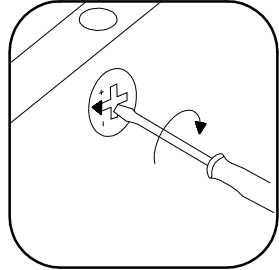
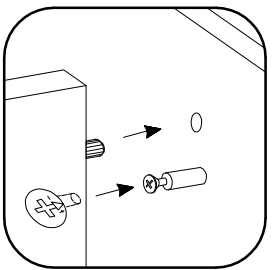
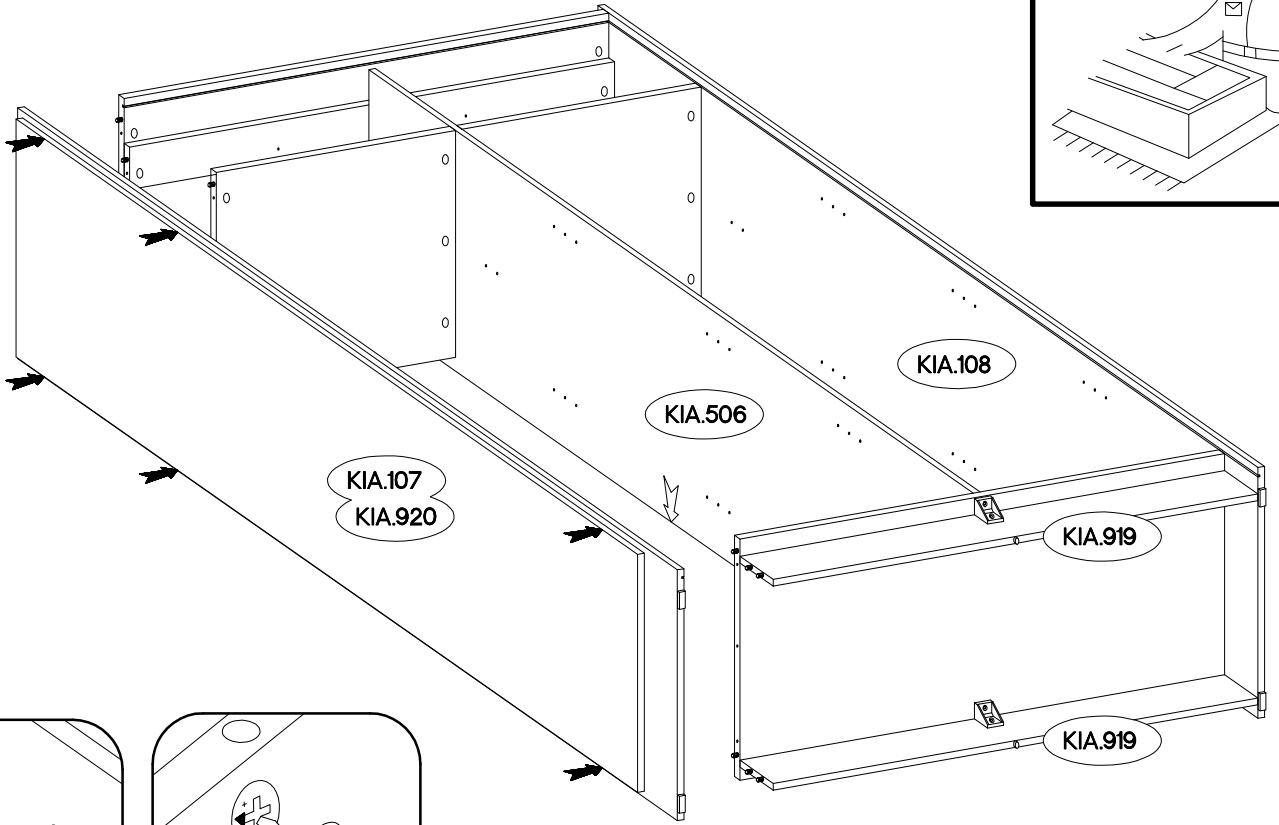
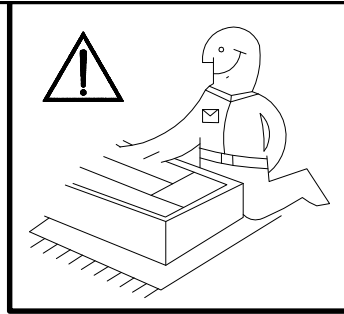

11





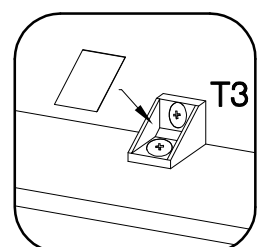
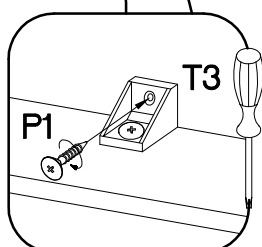
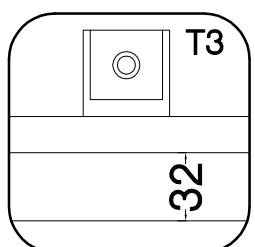
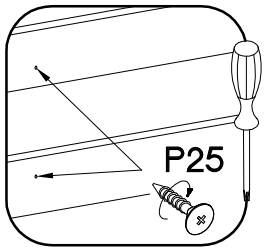
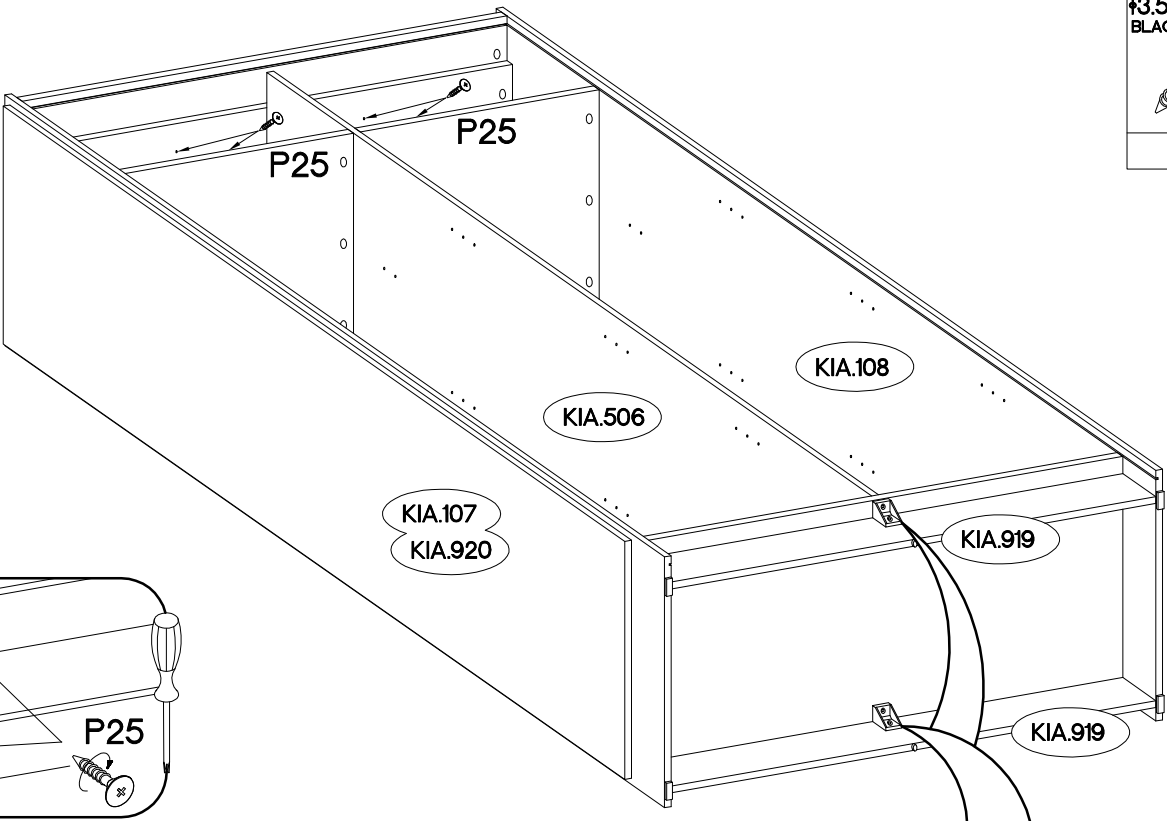

12

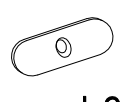
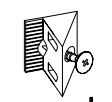
#3.5x25mm BLACK  P25 4	#4.0x16mm  P1 2
--	--

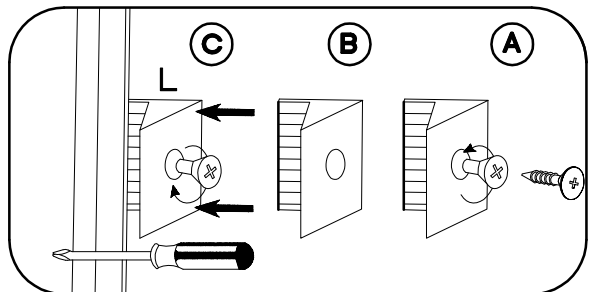
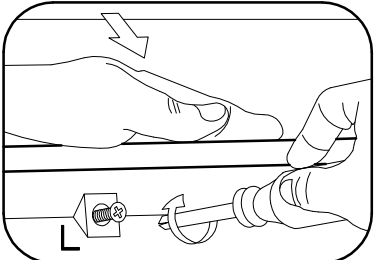
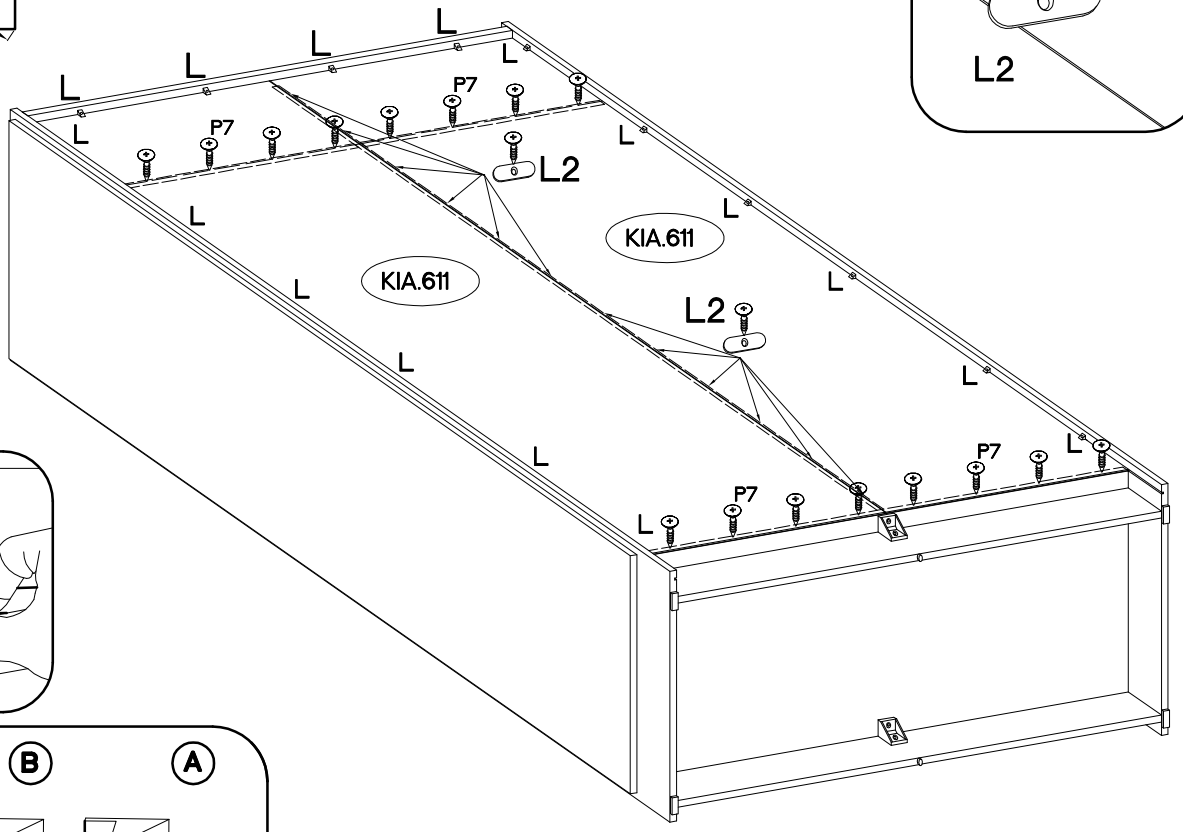
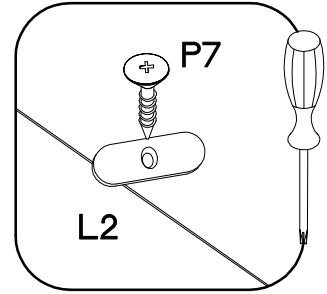
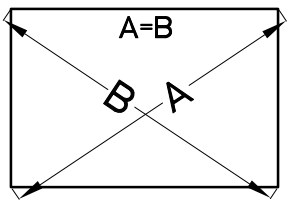
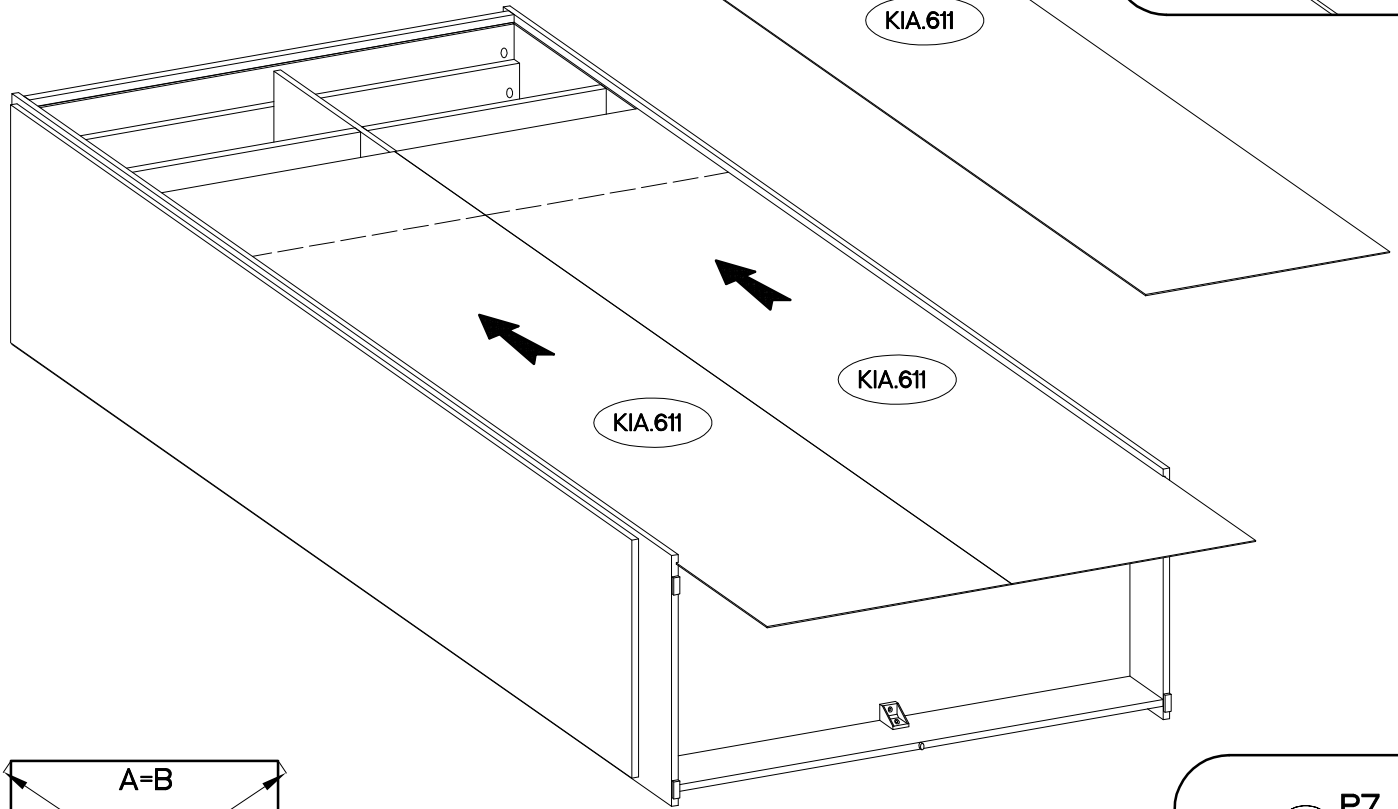
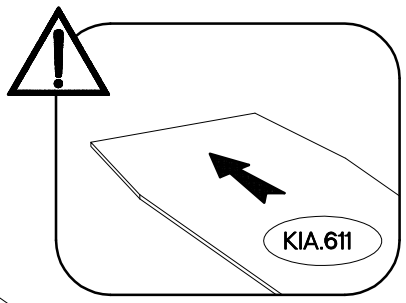

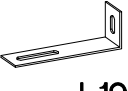
+3.0x20mm		
		
P7	L2	L
28	12	16





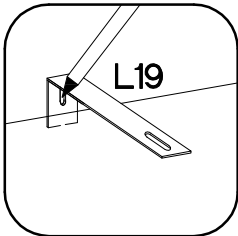
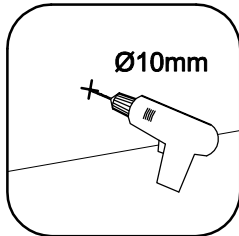
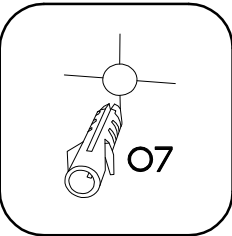

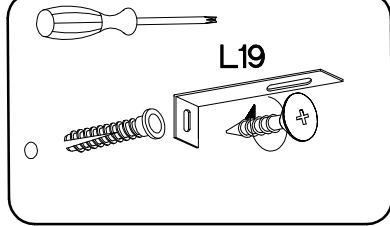
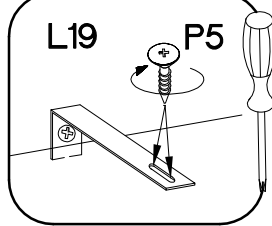

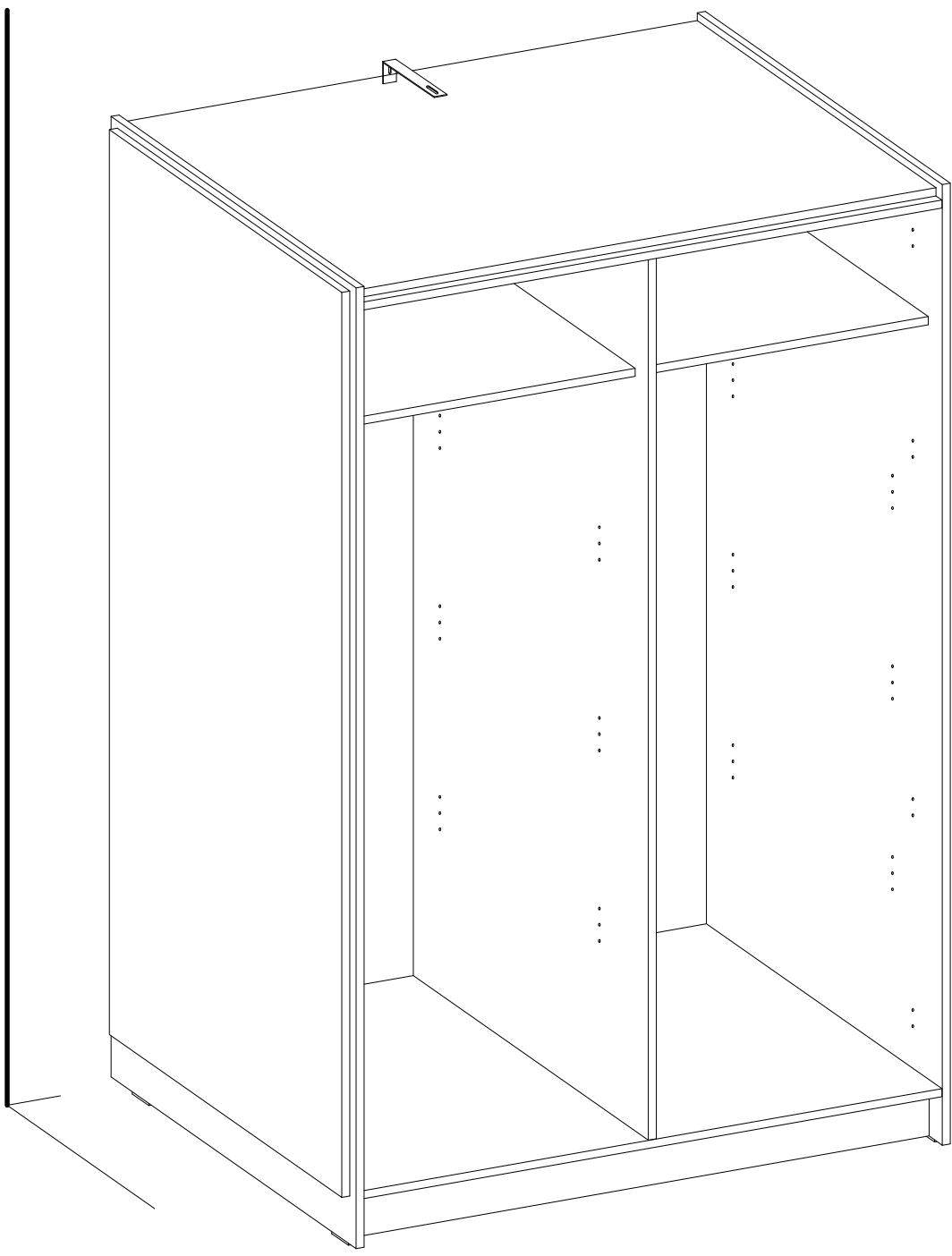
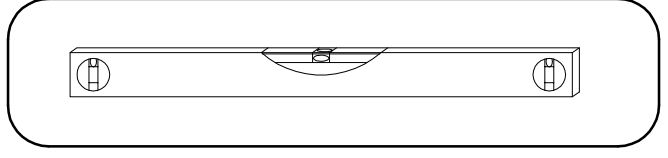
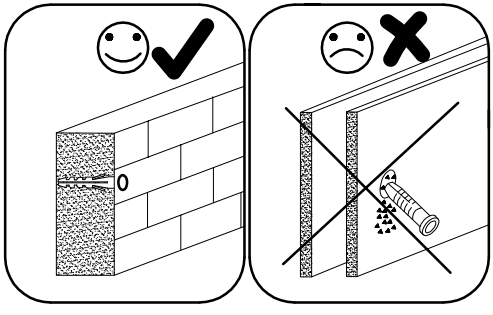
75x30x15mm	±3.5x13mm	±5.0x60mm	±10x50mm
			
L19	P5	P12	O7
1	2	1	1



1. 
2. 
3. 

4. 
5. 



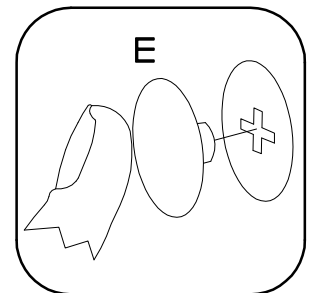
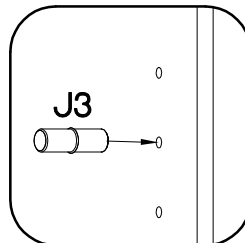
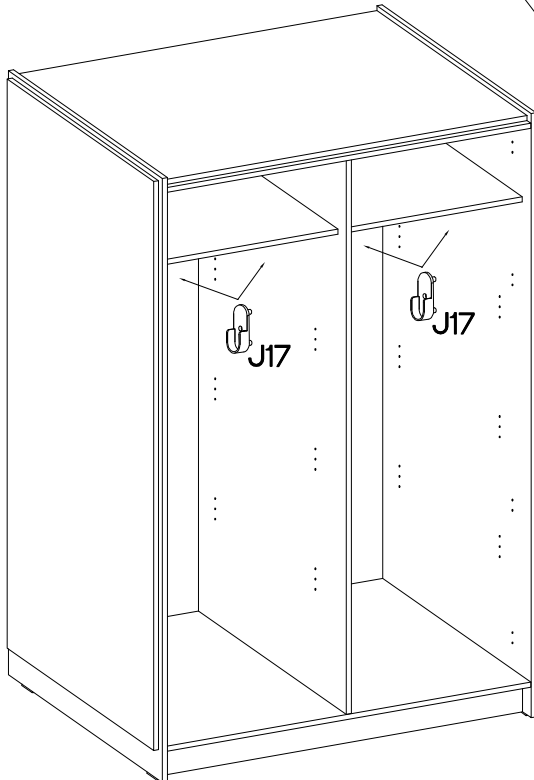
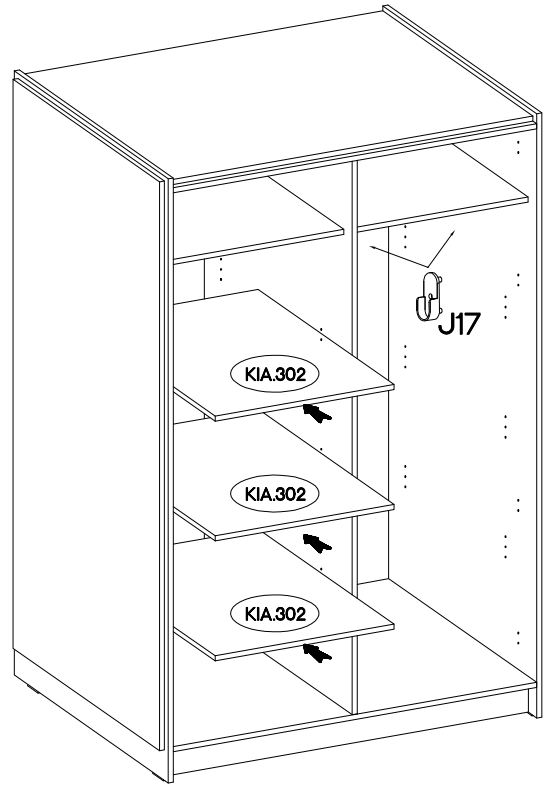
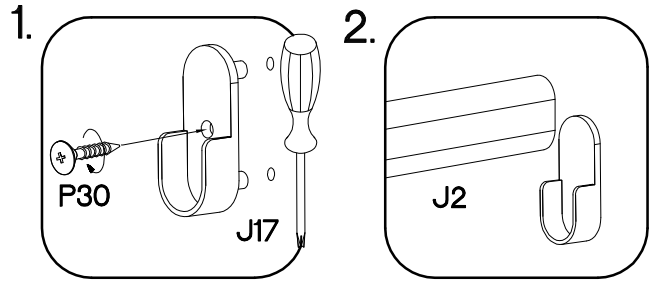
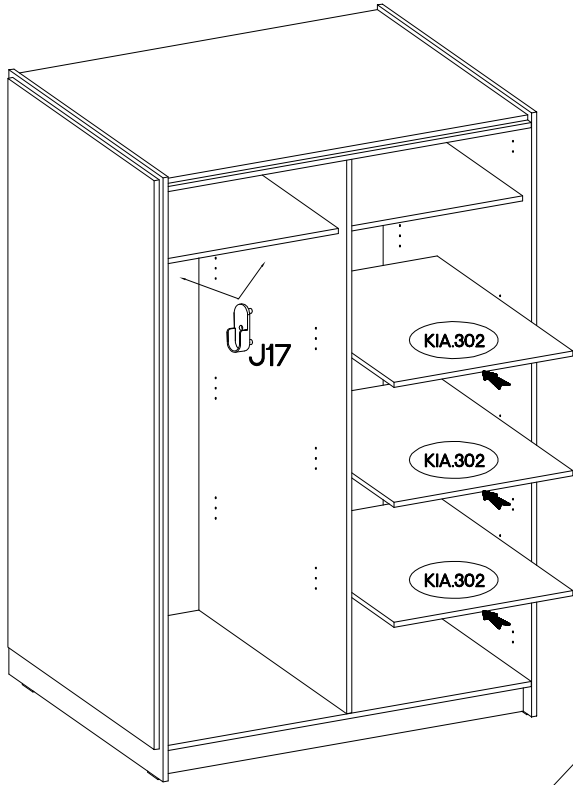

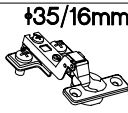
 J3	 J2	 J17	 P30	 E	 E
12	2	4	4	16	8

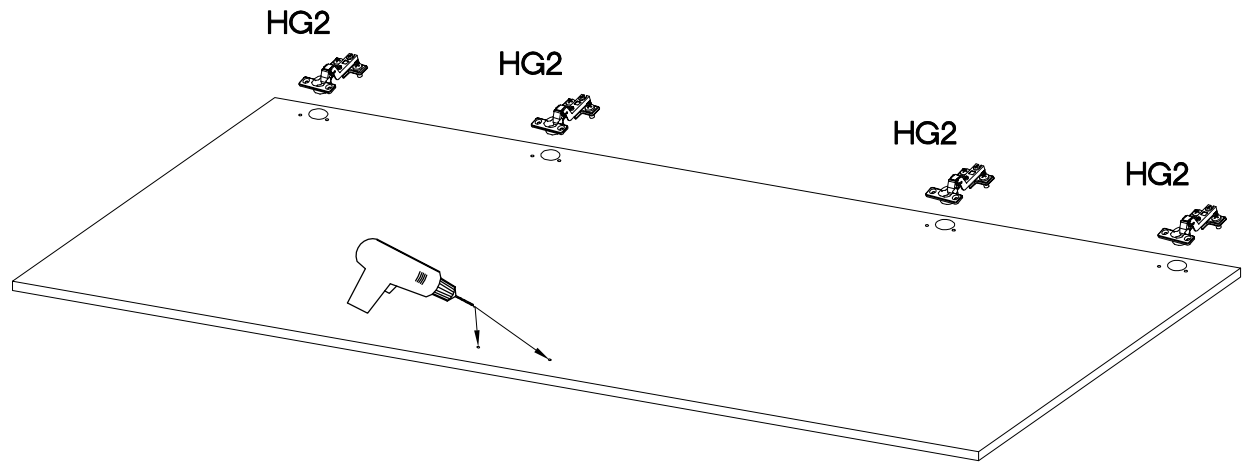
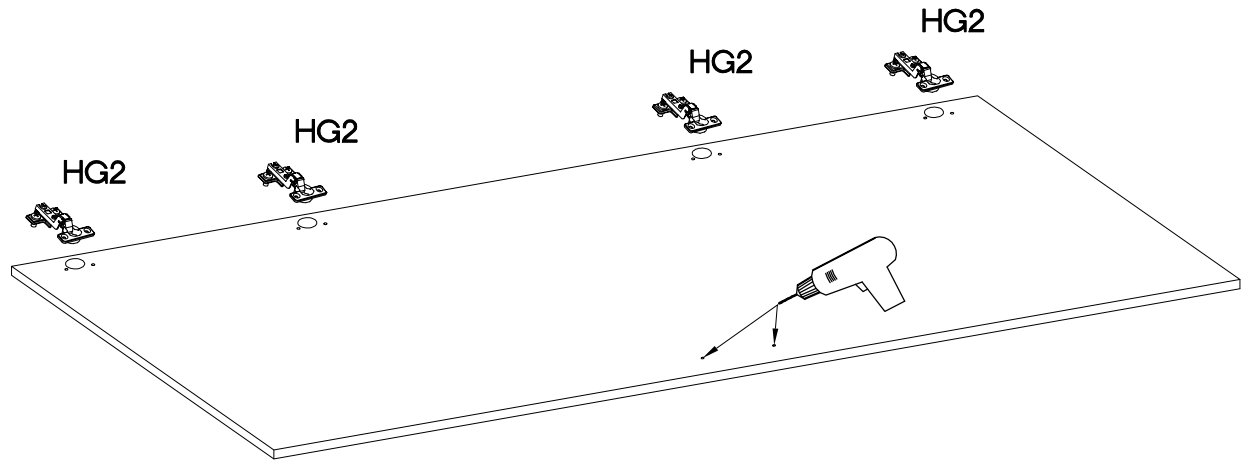
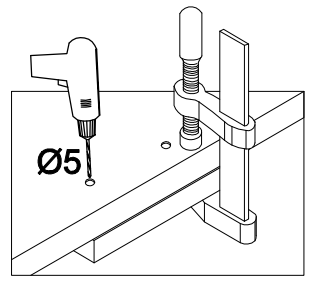
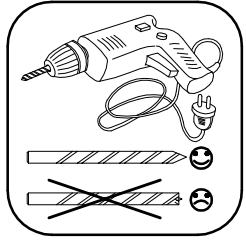
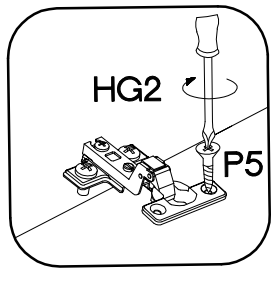

 HG2 8	 P5 16
--	--



L=128mm	M4x22mm
	
S	U
2	4

