

x 28

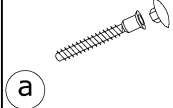

x 8

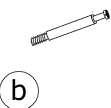

x 8

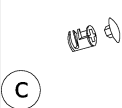

x 20

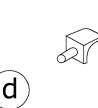

x 4

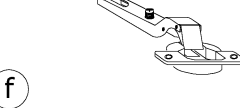

x 4

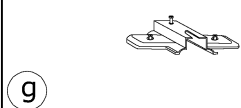

x 6

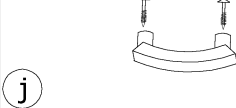

x 8 (3,5x30)

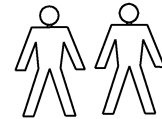

45 min



x 34 (3,5x16)

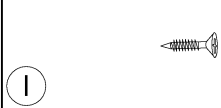

x 4



x 60

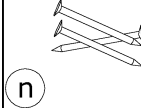

x 1

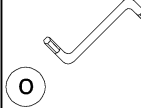

x 5



x 2 kpl. (400 mm)

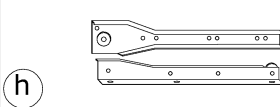

x 2 (377 mm)

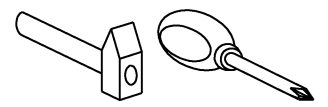
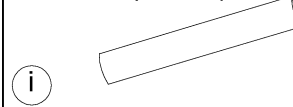

1 - FAZY MONTAŻU

A - OZNACZENIE ELEMENTÓW

a - OZNACZENIE AKCESORIÓW

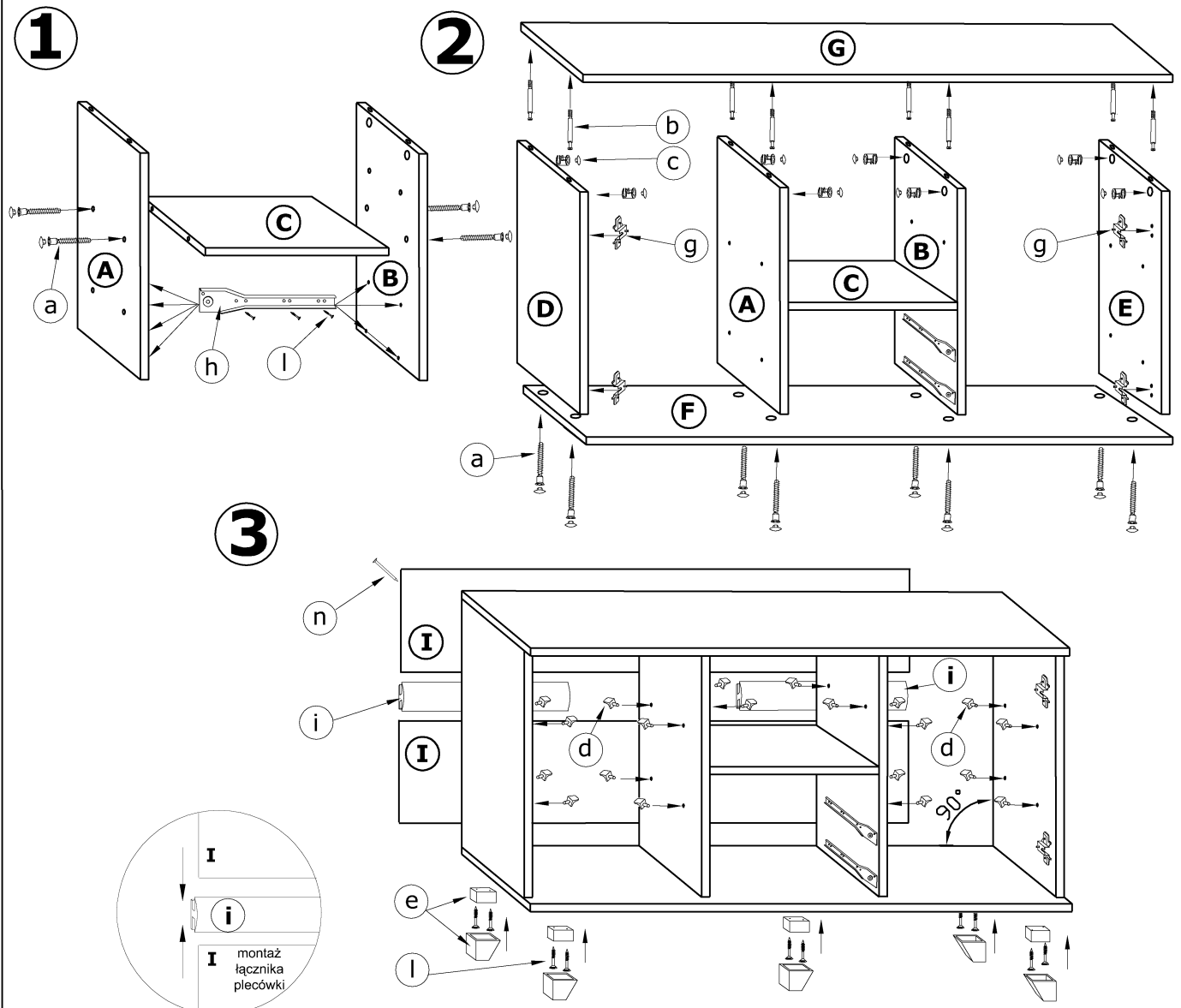

4

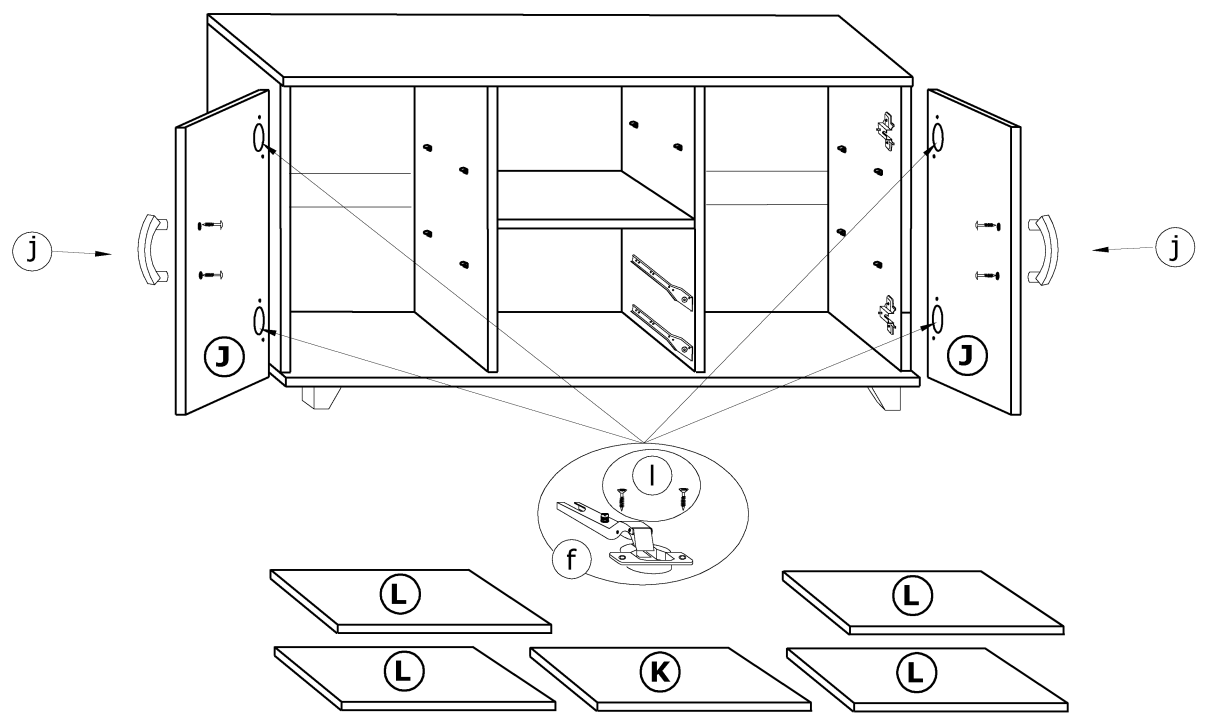

5

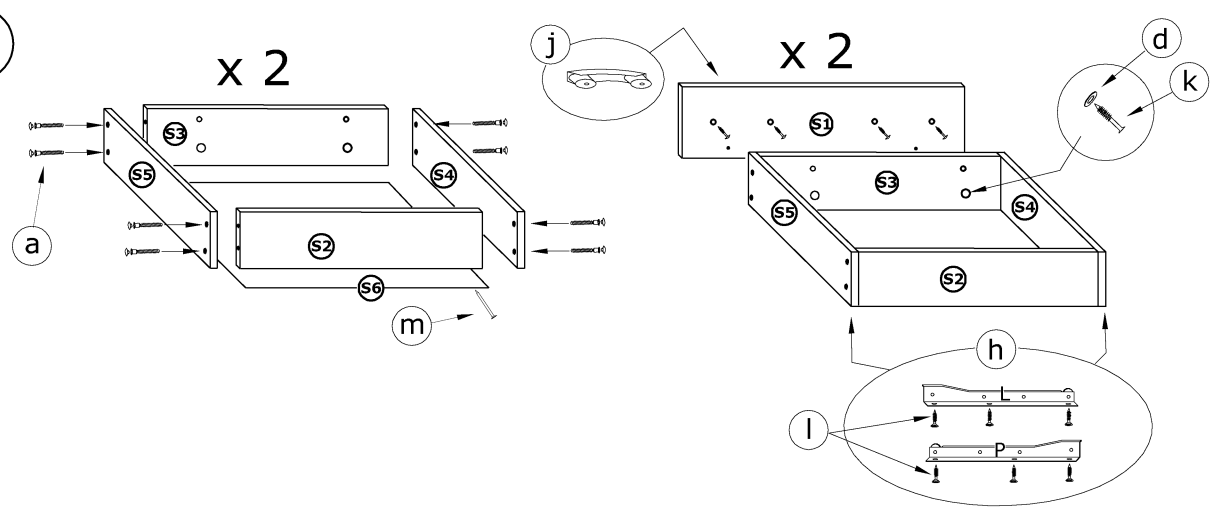

6

