

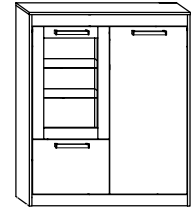

MXS-27 REGAŁ N2DW

→ 100 ↑ 121 ↘ 36



x 8 	x 20 	x 3 	x 23 	x 2 	x 16 	x 1
(a)	(b)	(c)	(d)	(e)	(f)	
x 7 	x 7 	x 5 	x 14 (3,5x16) 	x 80 	(l)	
x 3 					40 min 	

1 - FAZY MONTAŻU

A - OZNACZENIE ELEMENTÓW

a - OZNACZENIE AKCESORIÓW

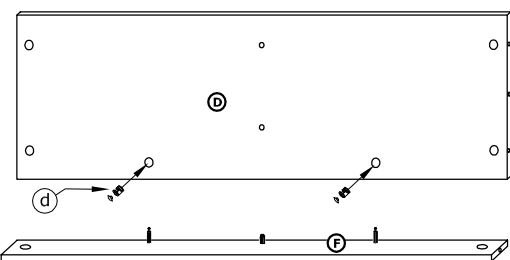
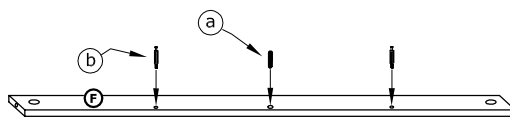
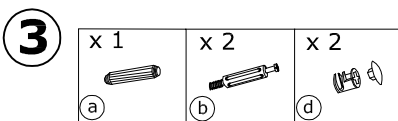
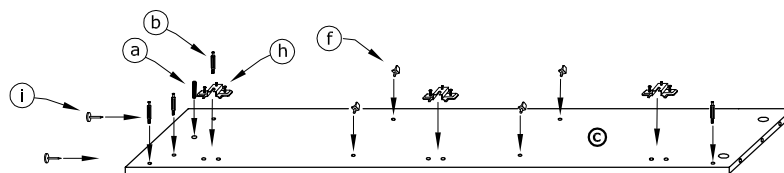
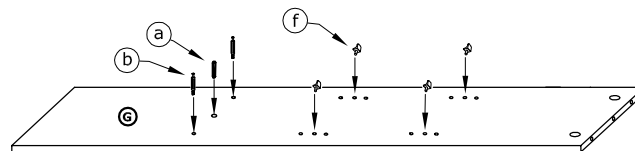
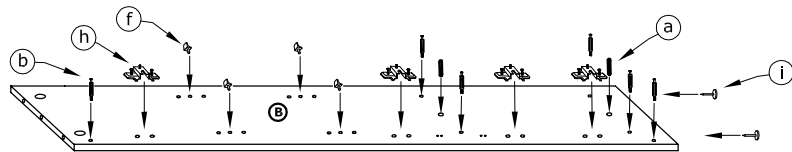
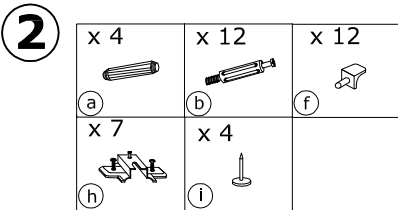
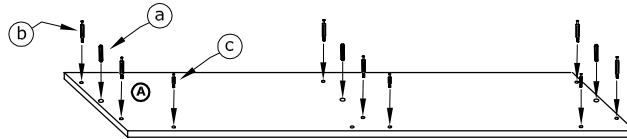
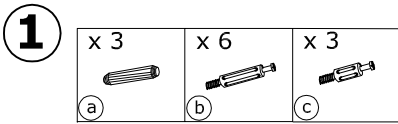

4

x 12



(d)

x 2



(e)

x 4



(f)

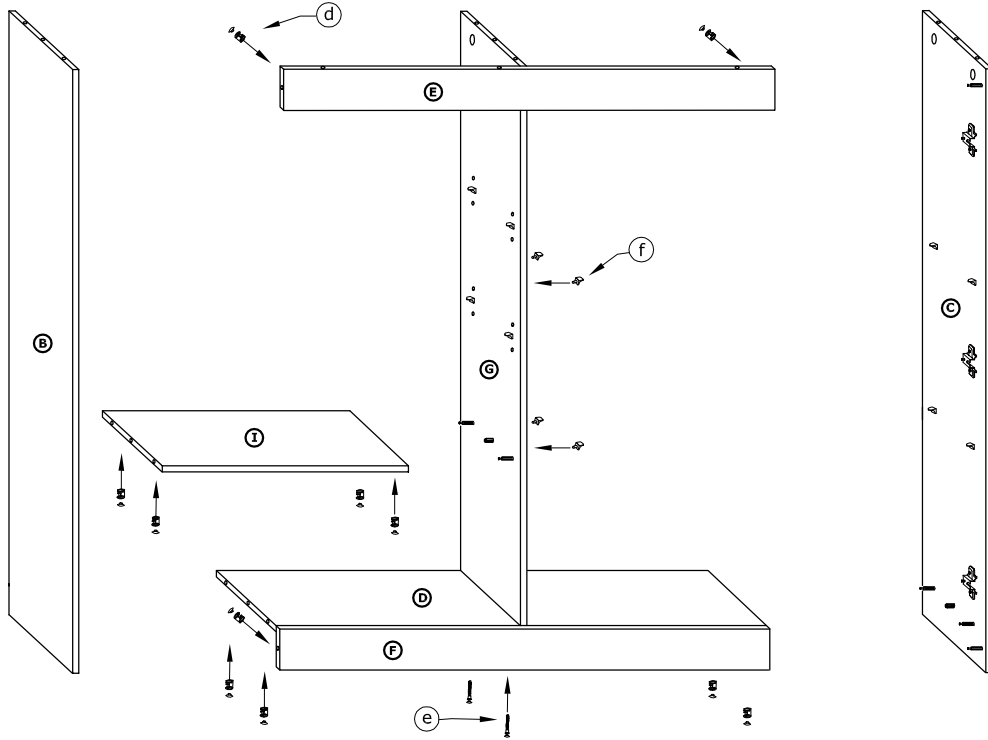

5

x 9



(d)

x 1



(i)

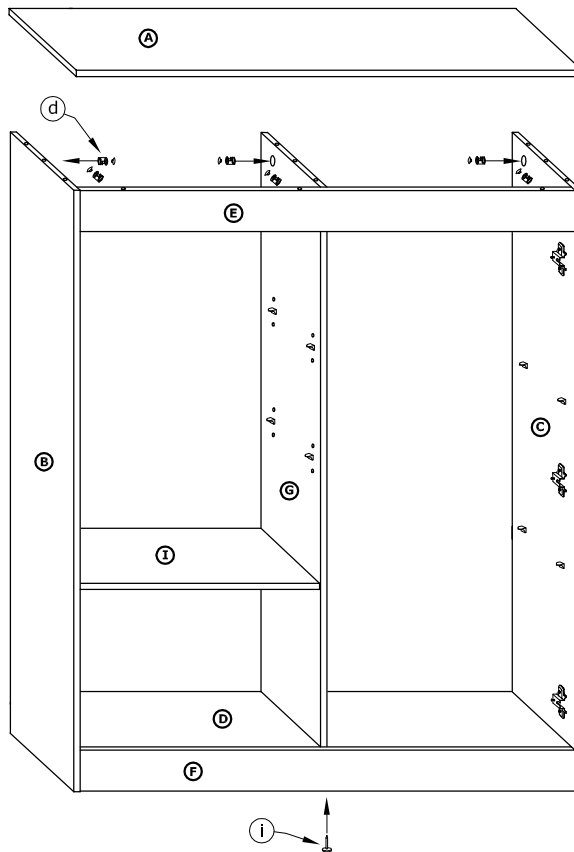

6

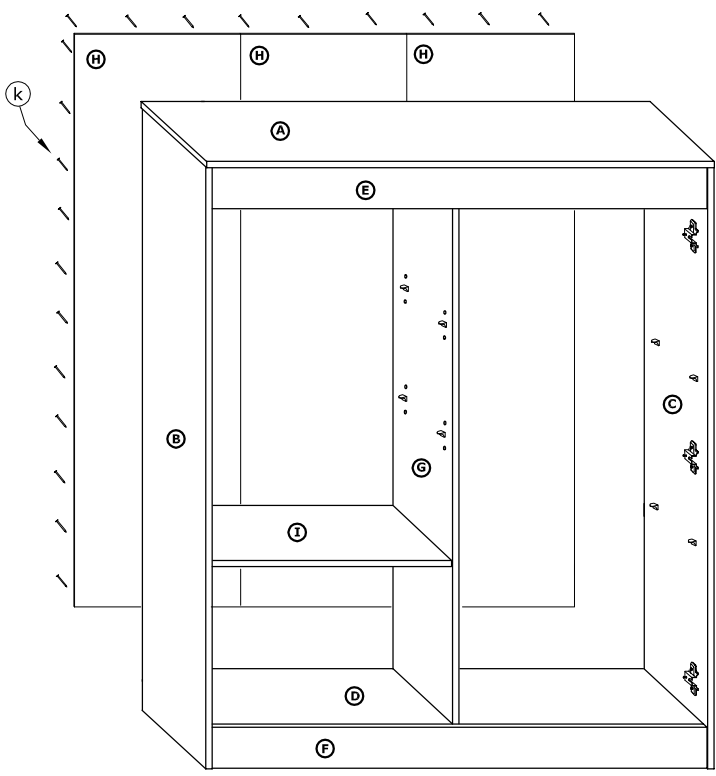
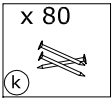

7

