

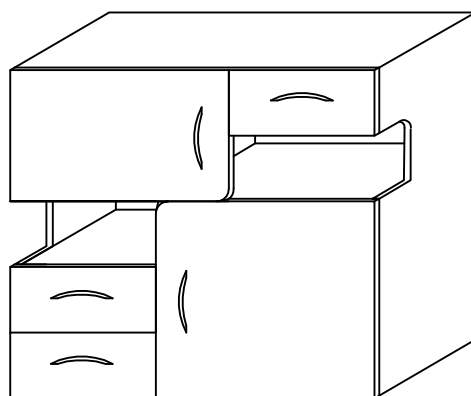

# FX 09



## ZASADY UŻYTKOWANIA MEBLI:

1. Meble powinny być użytkowane zgodnie z ich konstrukcją i przeznaczeniem.
2. Meble powinny być przechowywane i używane w odpowiednich warunkach tj. nie należy dopuszczać do nadmiernego przegrzewania (przesuszenia), unikać wilgoci (zamoczenia, przemarzania).
3. Meble powinny być używane w pomieszczeniach suchych i zabezpieczonych przed szkodliwymi wpływami atmosferycznymi oraz bezpośrednim działaniem promieni słonecznych.
4. Mebli nie należy ustawiać w odległości mniejszej jak 1 metr od czynnych grzejników.

## NIE UWZGLĘDNIĄ SIĘ ZGŁOSZEŃ REKLAMACYJNYCH OBEJMUJĄCYCH:



















1. Uszkodzenia powstałe w wyniku niewłaściwego przewozu bądź przenoszenia mebli oraz złego montażu, jak również wynikiłe po sprzedaży ze zdarzeń losowych i innych okoliczności.
2. Uszkodzenia powstałe w wyniku niewłaściwego użytkowania, przechowywania i konserwacji, jak również po stwierdzeniu napraw przez osobę nieupoważnioną.
3. Wady i uszkodzenia w następstwie których obniżono cenę wyrobu.

## UWAGA !

W dniu zakupu mebli należy sprawdzić (najlepiej w sklepie) stan zakupionych mebli tzn.:

1. Czy towar jest zgodny z zamówieniem
2. Czy elementy nie są uszkodzone i czy ich ilość wraz z akcesoriami jest zgodna z poniższym wykazem

Wykaz	Wymiar (mm)	Ilość
A	864x420	2
B	1000x420	1
C	1000x420	1
D	180x416	2
E	529x416	1
F	324x416	2
G	693x416	1
H	144x416	1
I	435x416	1
J	964x416	1
K	330x120	6
L	349x120	3
M	397x178	3
N	597x357	1
O	597x537	1
P	353x347	3
R	988x888	1

a	b	c	d	e	f	g	o	p	
									
x 10	x 5	x 4	x 32	x 32	x 4	x 8		x 2	
									
	x 4	x 12	x 1	x 32	x 4	x 60	x 3	x 4	x 32
j	k	l	m	n	h	i		r	



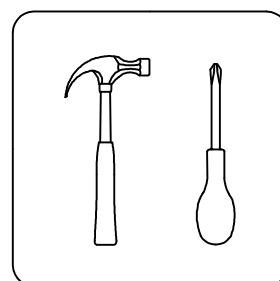

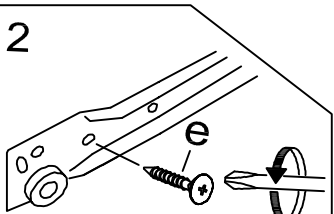
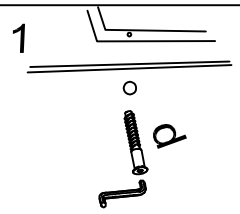
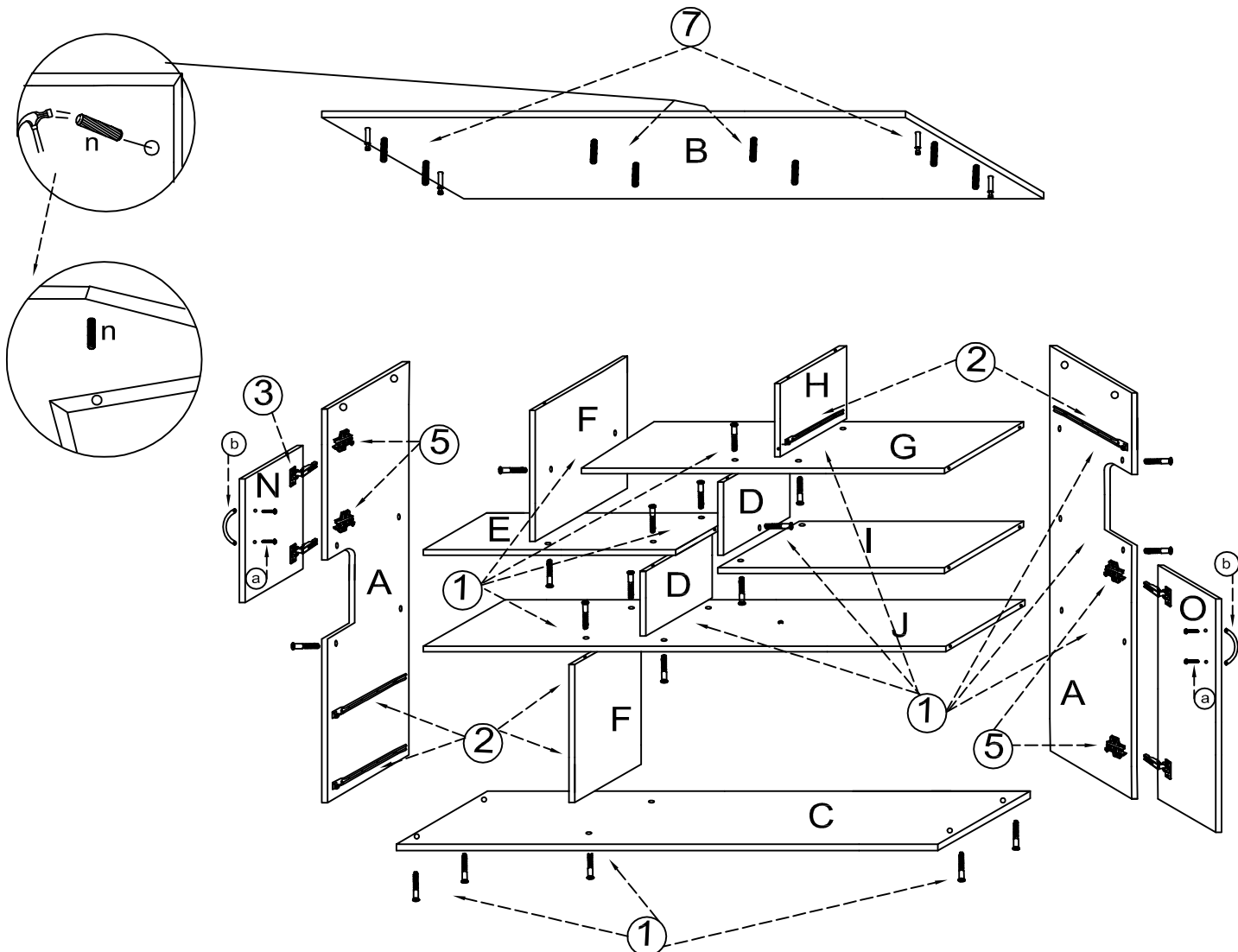



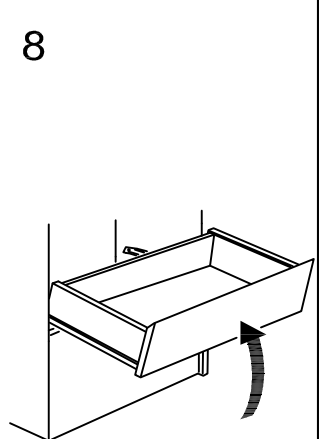
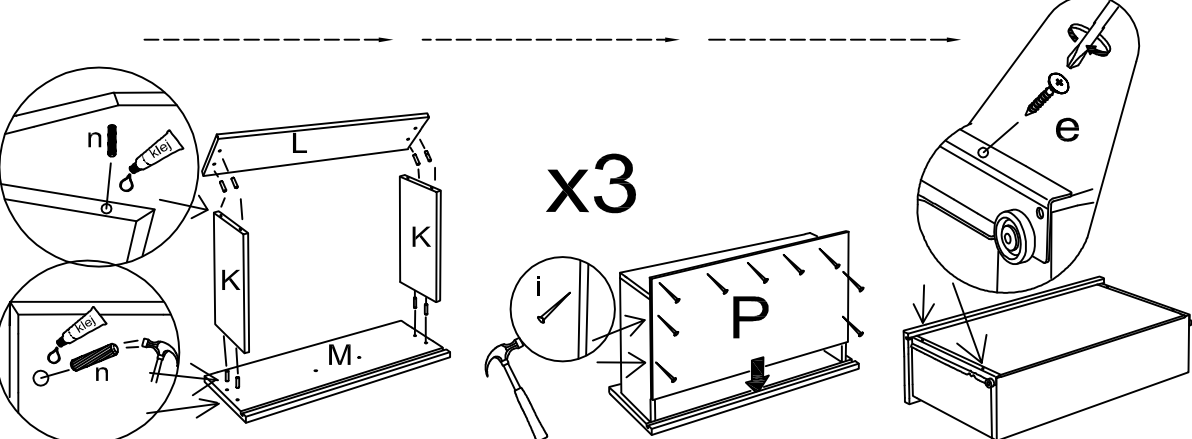
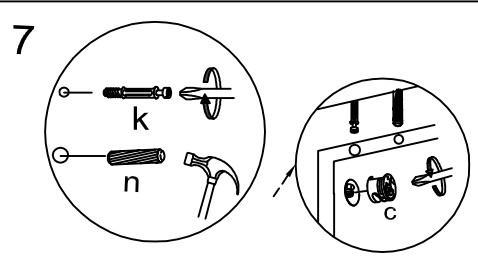
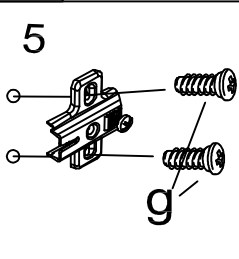
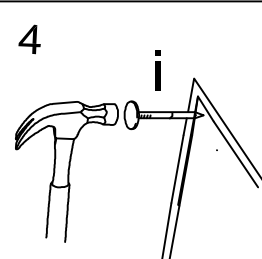
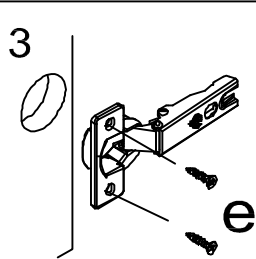

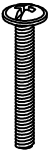
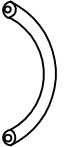

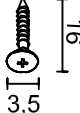
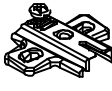

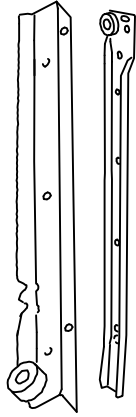
## DO MONTAŻU POTRZEBNE SĄ:



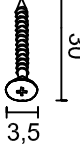

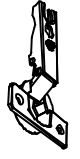
**UWAGA !**  
**KROK 1:** montujemy akcesoria tzn. nabijamy kołki drewniane, wkręcamy młotowkrętki itd. do poszczególnych elementów.  
**KROK 2:** łączymy elementy D,E,I(rys.1), później dodajemy kolejno element J,F,H,A,C(rys.1), element B (rys.7)  
**KROK 3:** przybijamy plecy HDF (R) i obsadzamy drzwi oraz szuflady (rys.8)  
**UWAGA KLEJ STOSUJEMY TYLKO DO MONTAZU SZUFLADY..**



a	b	c	d	e	f	g	o	p	s
 x 6	 x 3	 x 4	 x 34	 x 22	 x 7	 x 14	 x 1	 x 1	
 x 12	 x 4	 x 8	 x 1	 x 12	 x 7	 x 60		 x 4	 x 34
j	k	l	m	n	h	i		r	