

MONTAGEANLEITUNG INSTRUKCJA MONTAŻOWA

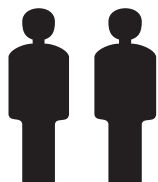

2 Personen
2 Osoby

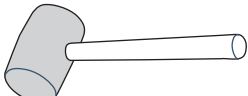
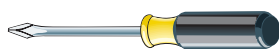
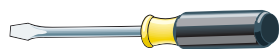
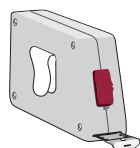
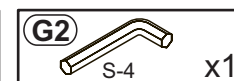
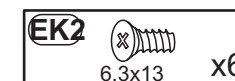
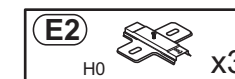
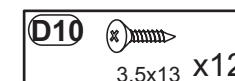
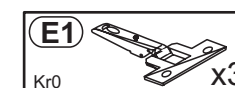
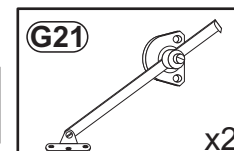
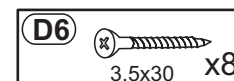
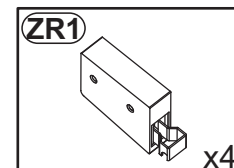
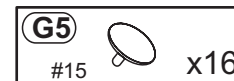
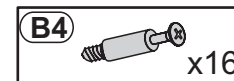
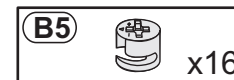
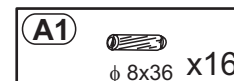
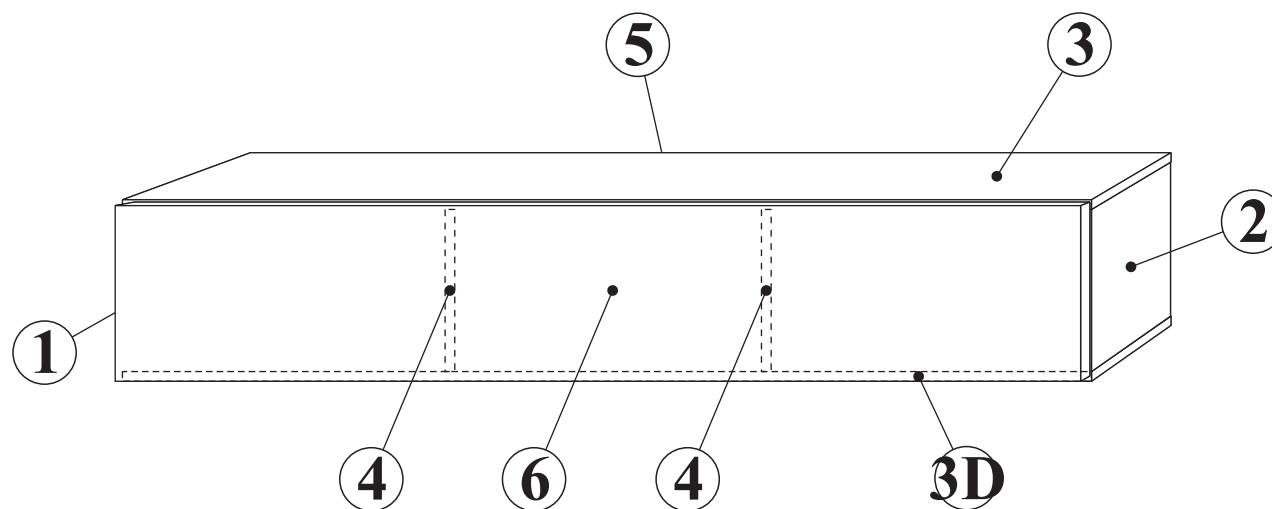

Max. zulässige Belastungen
 von Einlegeböden in kg:

Maksimalne obciążenie półek w kg:

Stärke/Gr. Länge/Dł. mm	Spanplatte/Płyta		
	15	18	22
0<400			
401<600	40	40	40
601<800	24		
801<1000	15	30	

Pflegehinweis!

Bitte nur mit einem Staubtuch oder einem feuchten Lappen reinigen.

KEINE scheuernde Putzmittel verwenden!

Wskazówka dotycząca pielęgnacji!

Proszę czyścić tylko suchą lub lekko wilgotną szmatką do kurzu. Nie używać żadnych środków szorstkich!

Modellname: **FLY**
Nazwa modelu:

Modellreihe: **23 -- FL**
Numer modelu:

Type: **30**
Typ:

Blatt Nr **2** von: **5**
Strona **2** z: **5**

1

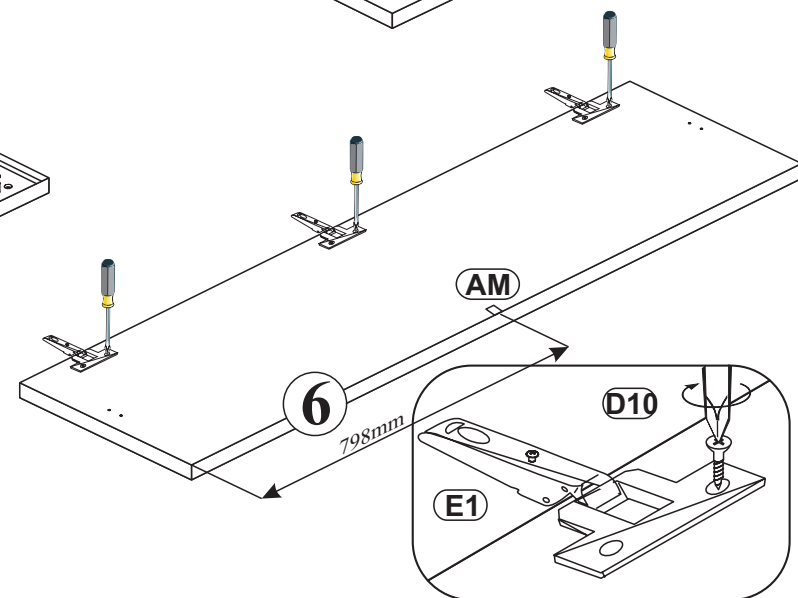
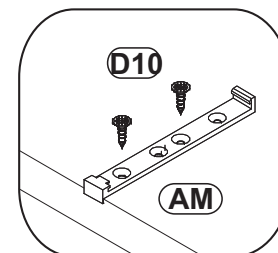
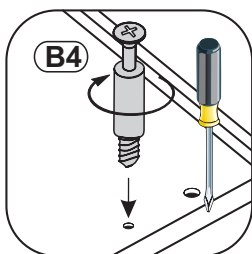
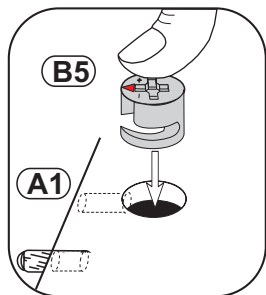
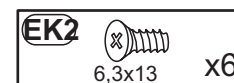
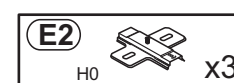
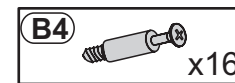
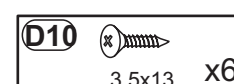
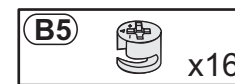
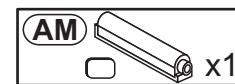
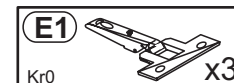
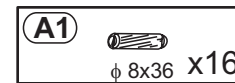
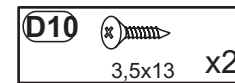
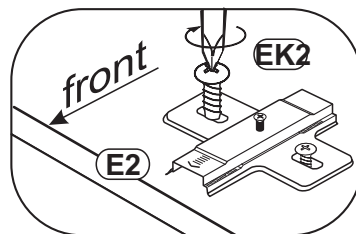
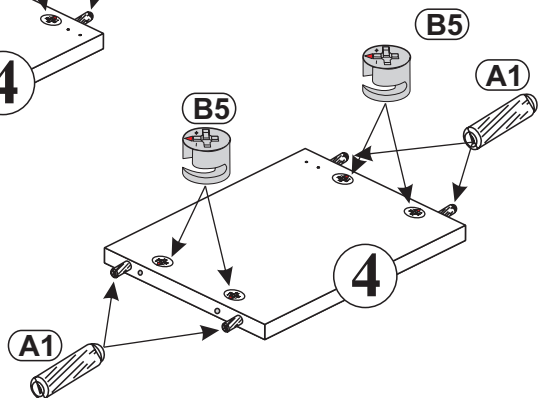
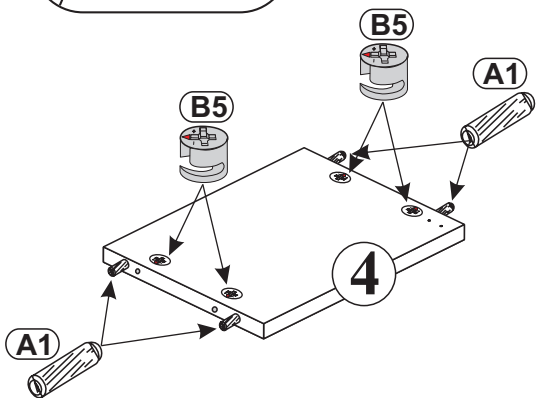
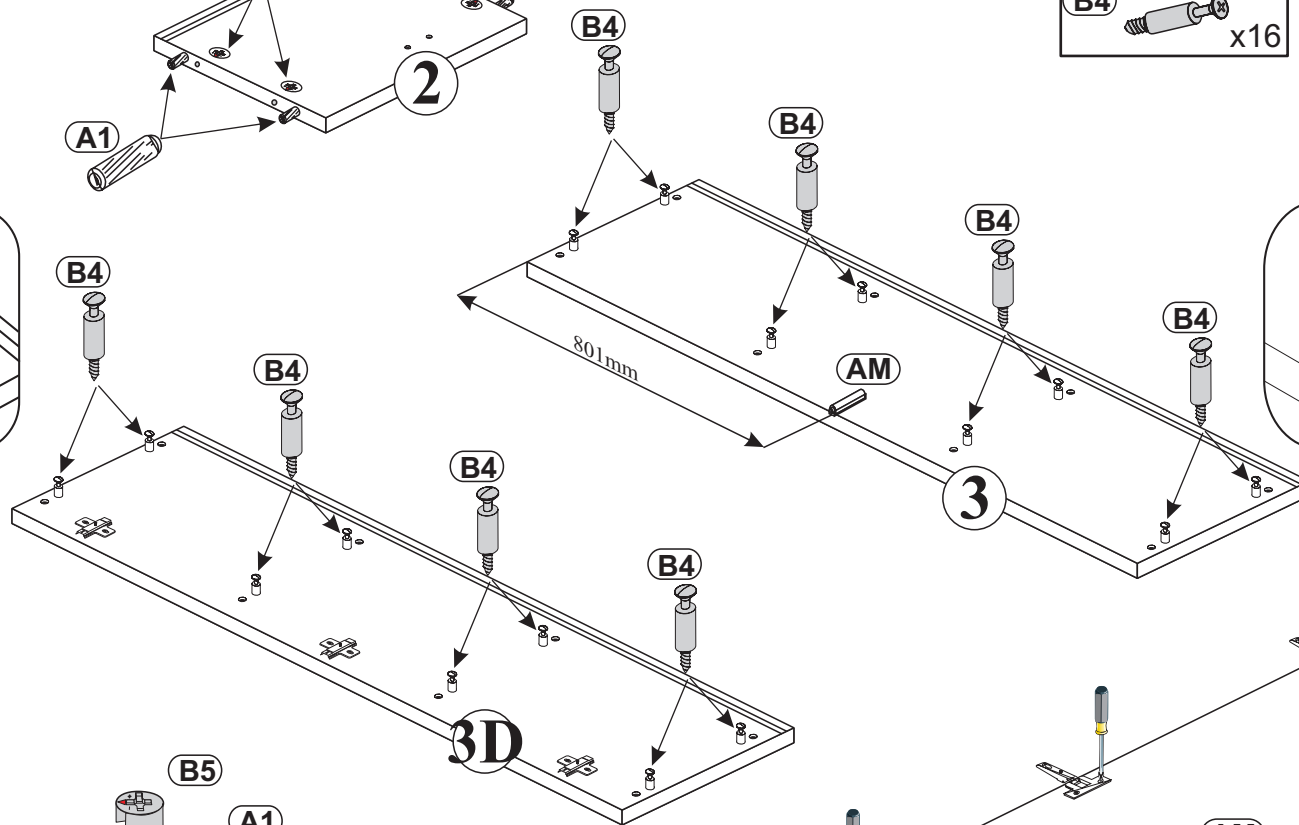
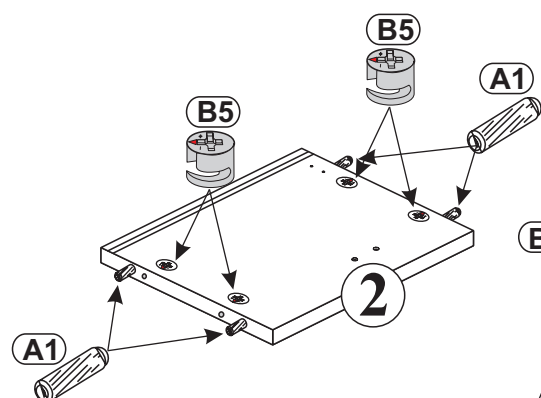
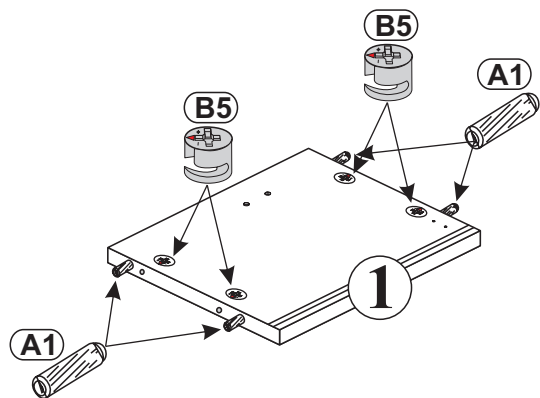

2

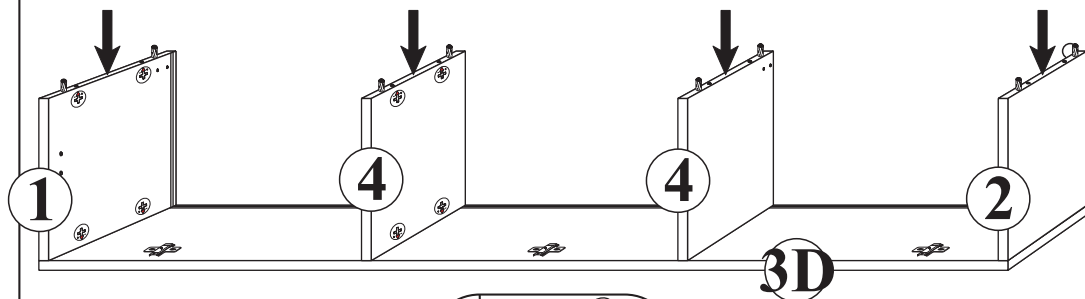

3D

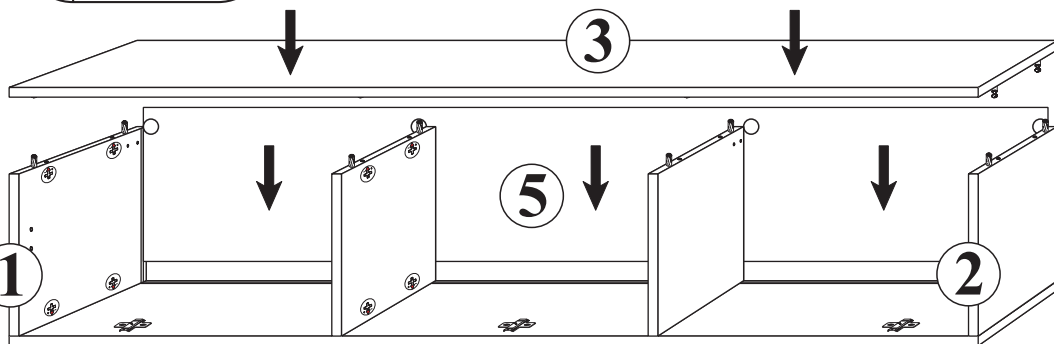
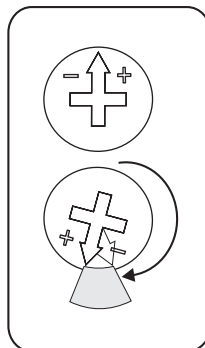
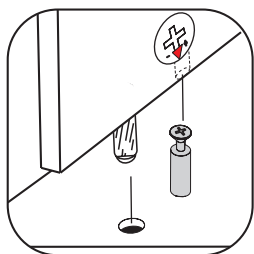
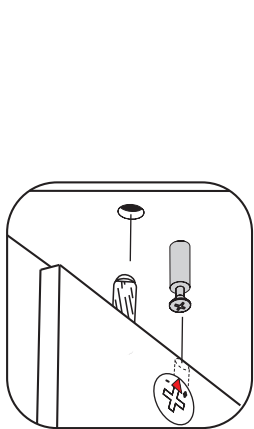

3

a=b

S1  **x12**

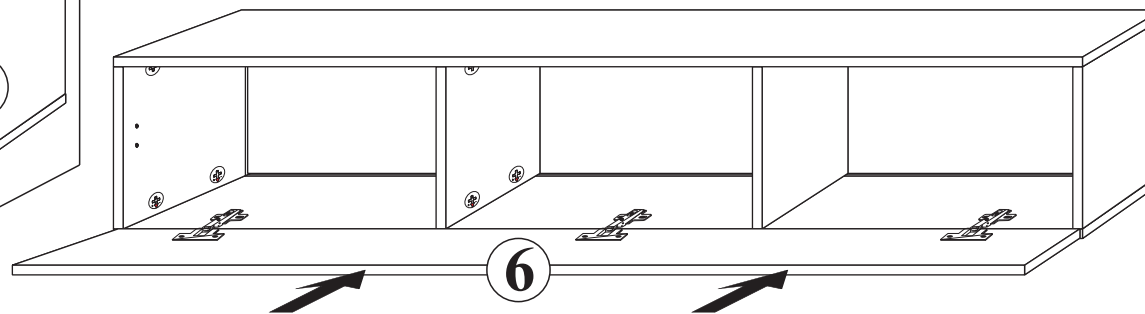
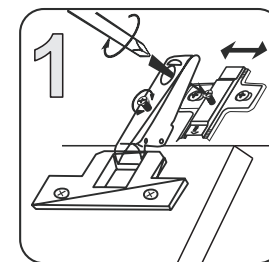
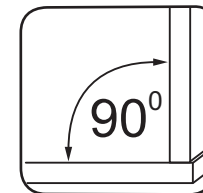
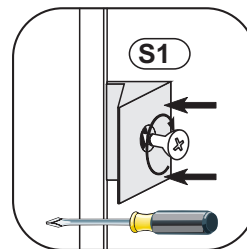
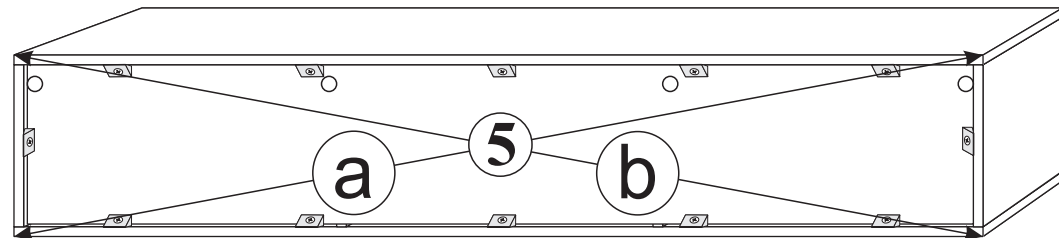

4

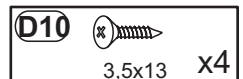
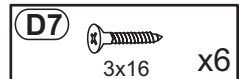
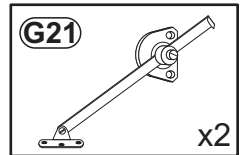
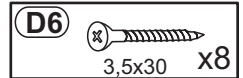
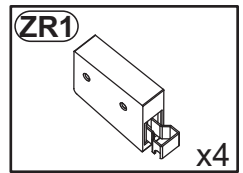
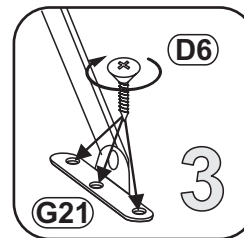
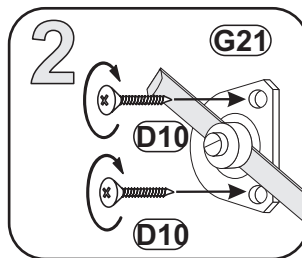
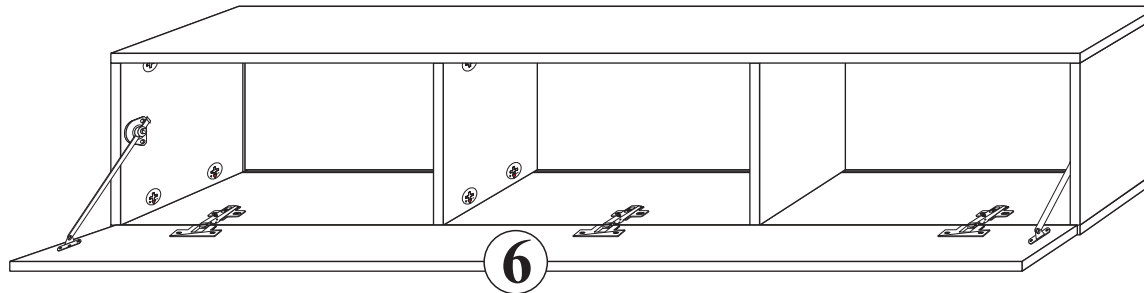
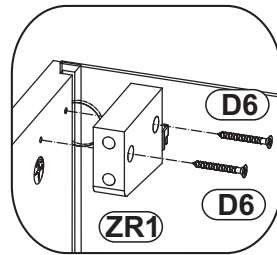

5

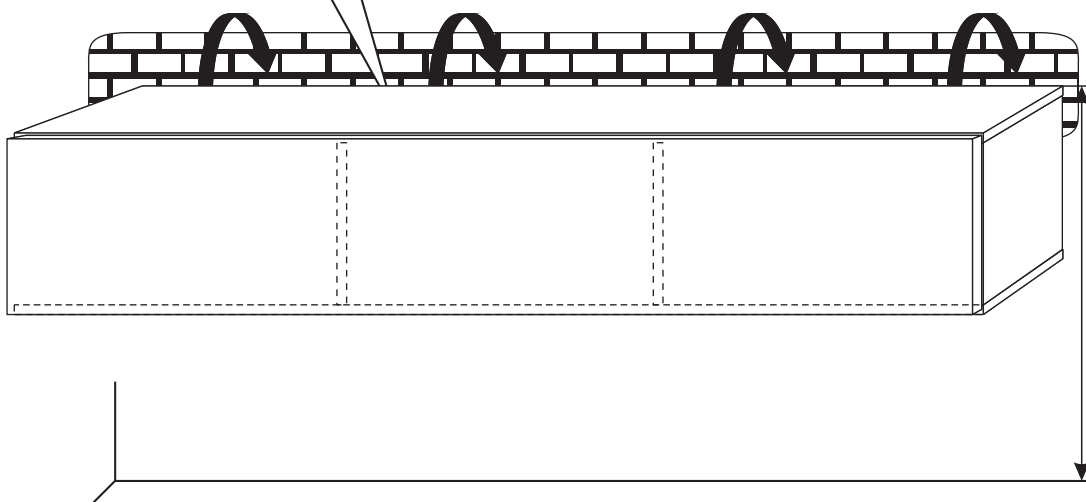
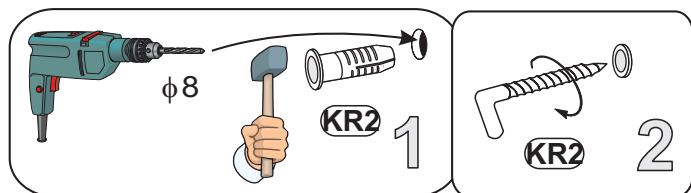
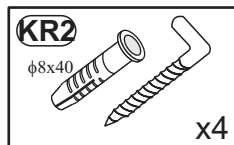
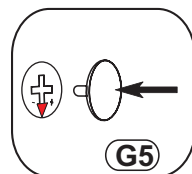
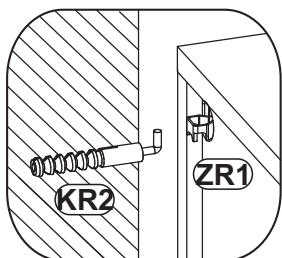

PL

Załączone kołki do zawieszania bryty, do stosowania wyłącznie do ścian betonowych, do innych ścian należy odpowiednio dokupić.

D

Die beigefügten Dübel zum Aufhängen des Elements dürfen nur bei Betonwänden eingesetzt werden, bei anderen Wandarten müssen entsprechende Dübel zugekauft werden.

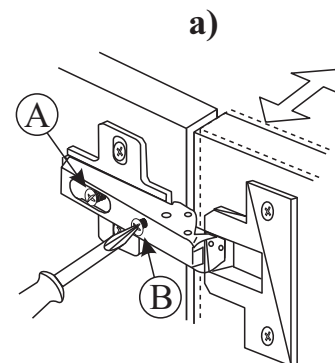

Verstellmöglichkeiten

- a) Fugenverstellung:
Befestigungsschraube "A" lockern, gewünschte Fuge mit Schraube "B" einstellen, Schraube "A" anziehen.
- b) Tiefenverstellung:
Befestigungsschraube "A" lockern, Bandarm nach vorne oder rückwärts verschieben, Schraube "A" anziehen, Schraube "B" mit einer 1/4 Drehung nach rechts arretieren.
- c) Höhenverstellung:
Befestigungsschraube "C" lockern, Höhe einstellen, Schraube "C" anziehen.

Instructions for hinge adjustment

- a) Side adjustment:
Loosen fixing screw "A", adjust gap with screw "B" and retighten screw "A".
- b) Depth adjustment:
Loosen fixing screw "A", push hinge arm forwards or backwards, retighten screw "A", fix screw "B" with a 1/4-turn in clock-wise direction.
- c) Height adjustment:
Loosen screw "C", adjust height, retighten screw "C".

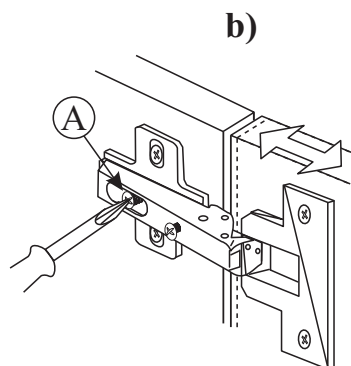

Les possibilités de positionnement

- a) Positionnement de la rainure:
Desserrer la vis de fixation "A", positionner avec la vis "B" la rainure (joint) souhaitée et resserrer la vis "A".
- b) Positionnement de la profondeur:
Desserrer la vis de fixation "A" (1 tour), régler la profondeur et resserrer la vis "A".
- c) Positionnement de la hauteur:
Desserrer la vis de fixation "C" (1 tour), positionner la hauteur et resserrer la vis "C".

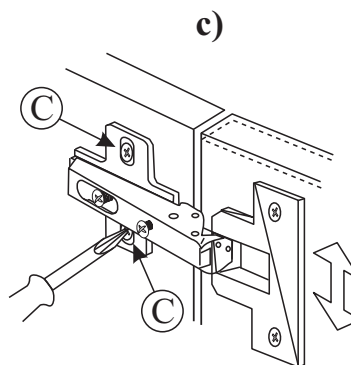

Możliwości regulacji

- a) Regulacja szczeliny:
Poluzować wkręt "A", wkrętem "B" ustawić odpowiednią szczelinę, dokręcić wkręt "A".
- b) Regulacja głębokości:
Poluzować wkręt "A" (1 obrót), ustawić głębokość, dokręcić wkręt "A".
- c) Regulacja wysokości:
Poluzować wkręt "C" (1 obrót), dokonać regulacji wysokości położenia drzwi, wkręt "C" dokręcić.

Modellname: **FLY**
 Nazwa modelu:

Modellreihe: **23 -- FL**
 Numer modelu:

Typ: **42**
 Typ:

Blatt Nr **1** von: **5**
 Strona **1** z: **5**

Typ:L

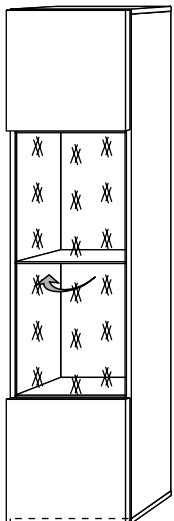

Typ:P

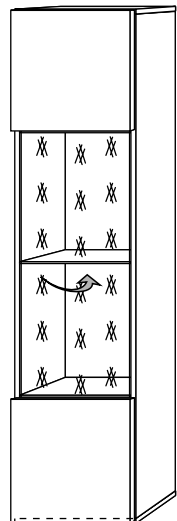

MONTAGEANLEITUNG INSTRUKCJA MONTAŻOWA

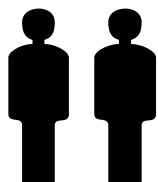

2 Personen
2 Osoby

Pflegehinweis!

Bitte nur mit einem Staubtuch oder einem feuchten Lappen reinigen.
KEINE scheuernde Putzmittel verwenden!

Wskazówka dotycząca pielęgnacji!

Proszę czyścić tylko suchą lub lekko wilgotną szmatką do kurzu. Nie używać żadnych środków szorstkich!

Max. zulässige Belastungen von Einlegeböden in kg:

Maksymalne obciążenie półek w kg:

Stärke/Gr.	Spanplatte/Płyta		
Länge/Dł. mm	15	18	22
0<400			
401<600	40	40	40
601<800	24		
801<1000	15	30	

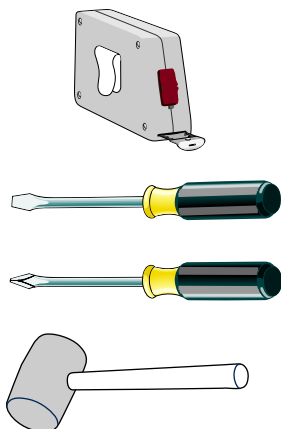
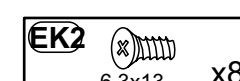
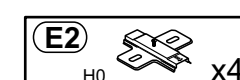
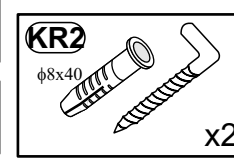
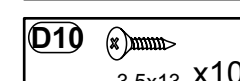
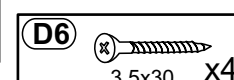
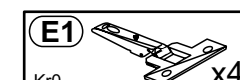
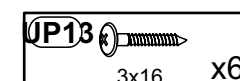
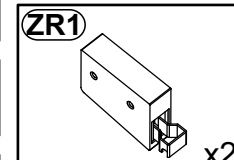
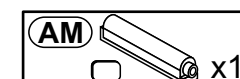
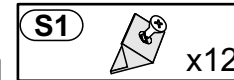
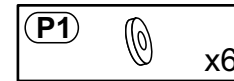
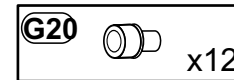
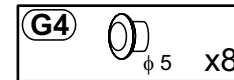
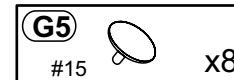
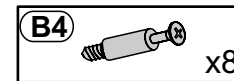
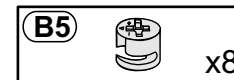
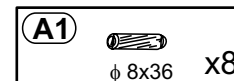
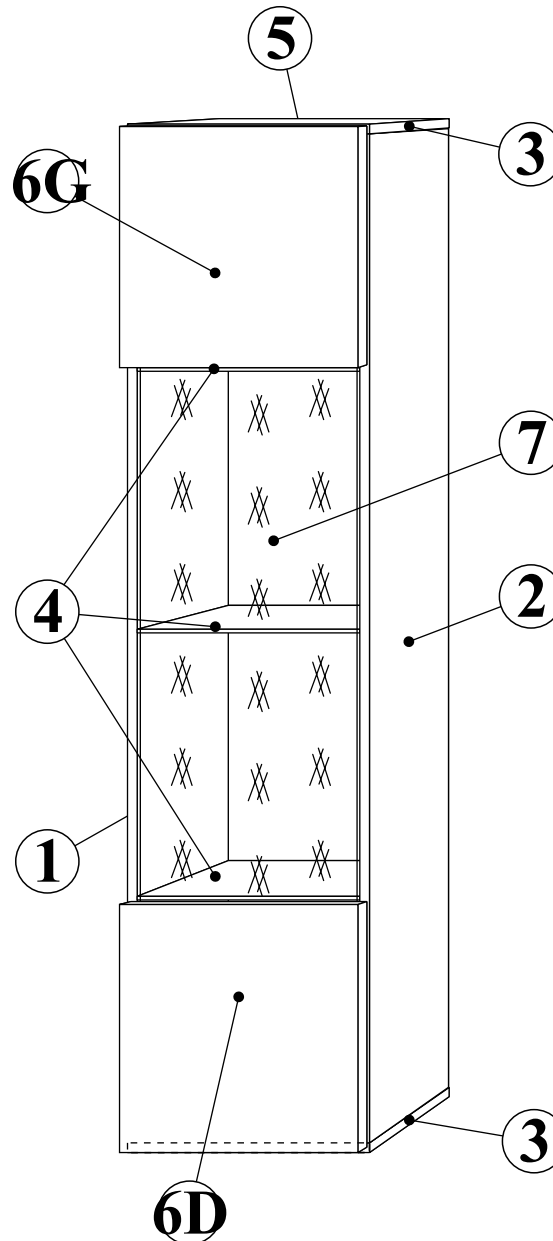

1

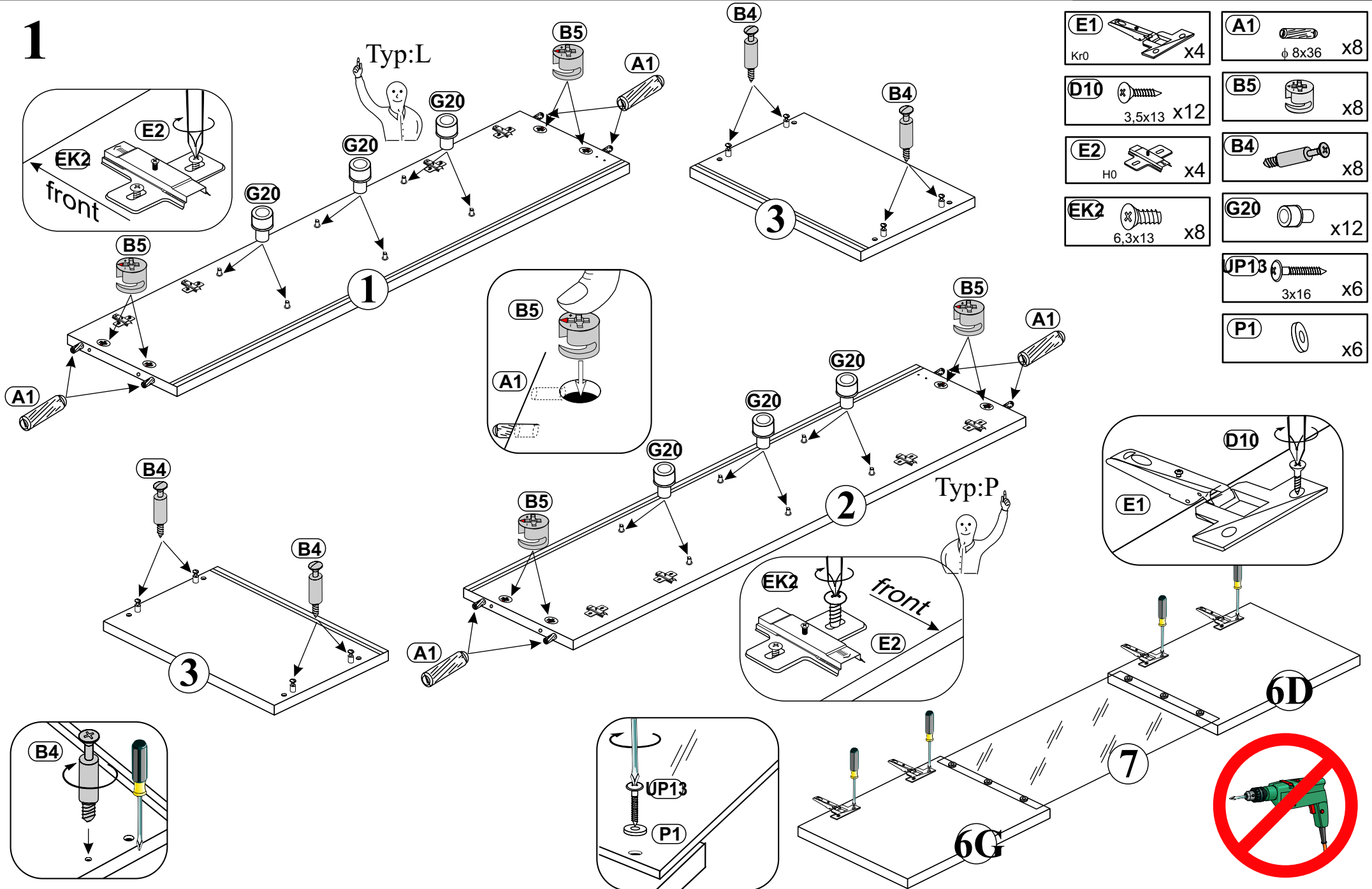

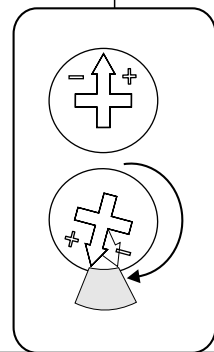
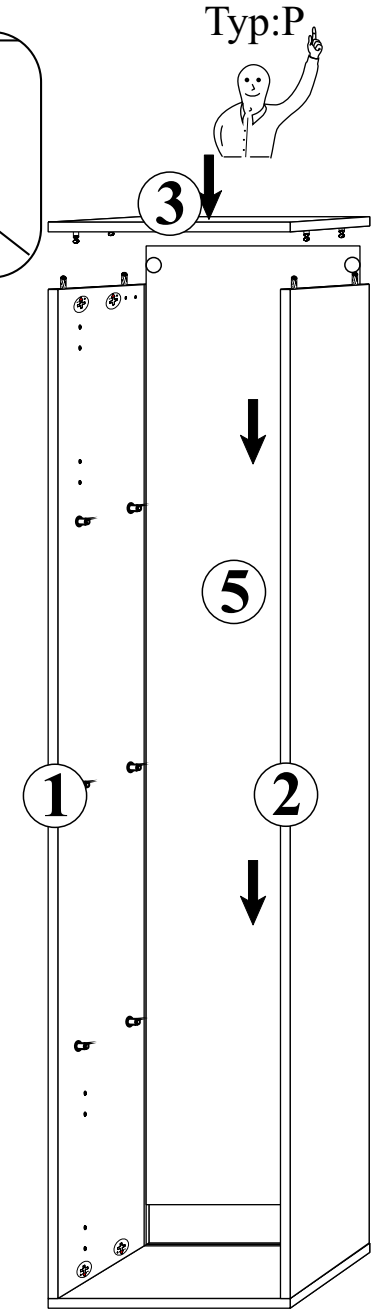
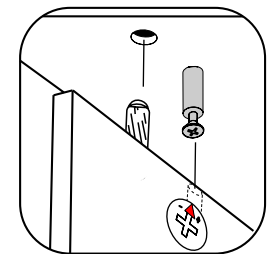
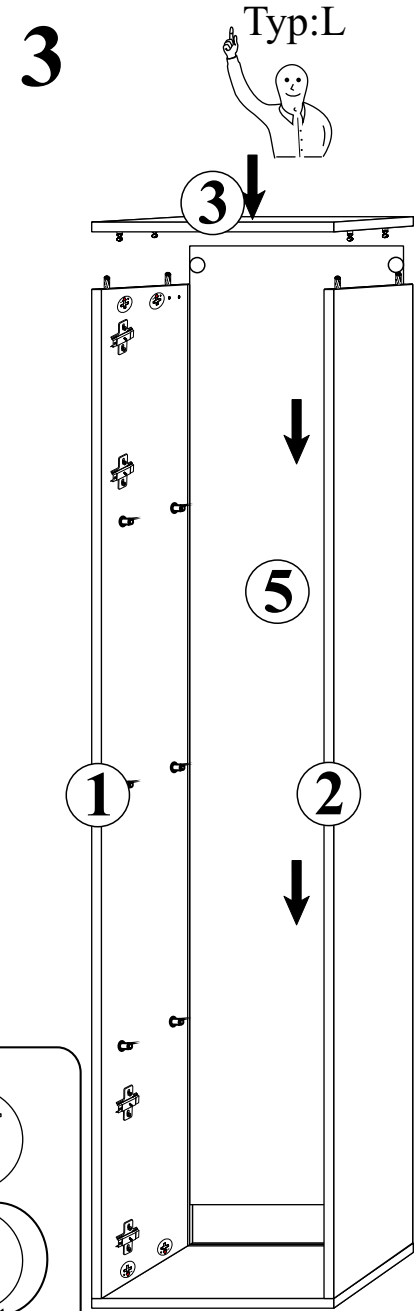
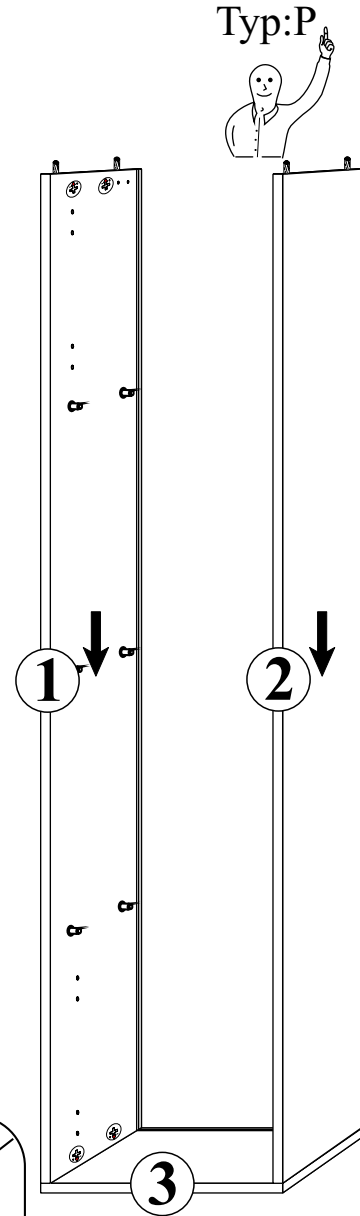
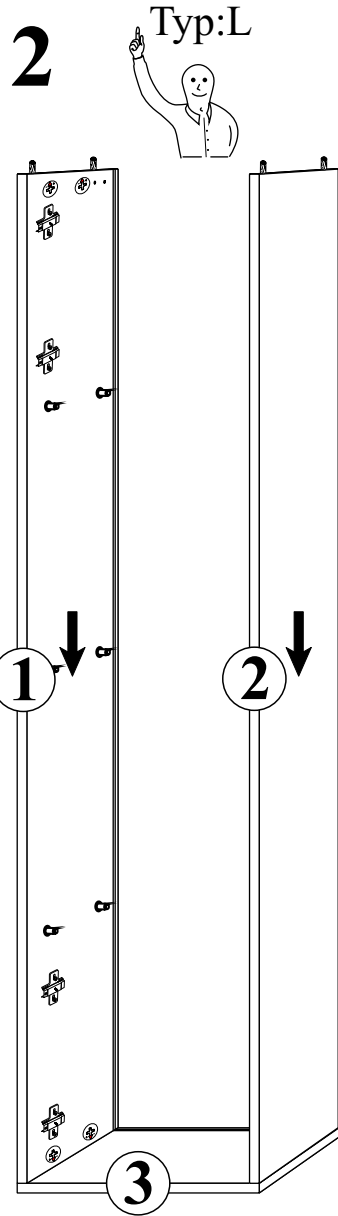

4



a=b

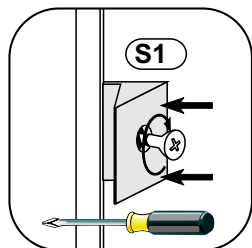
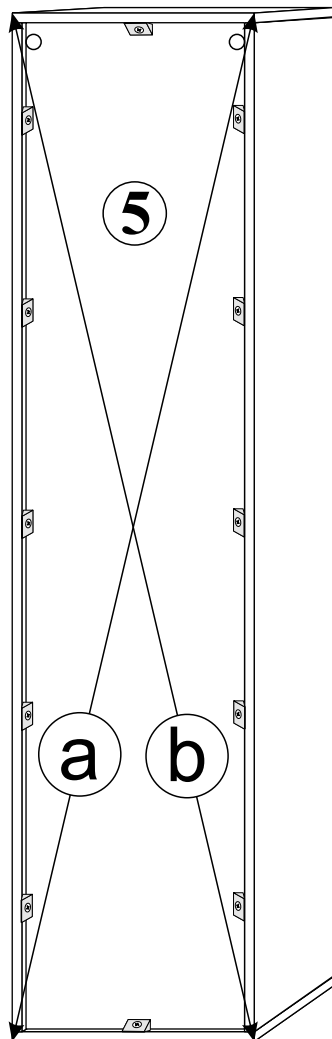

5

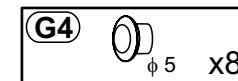
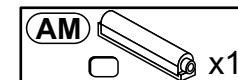
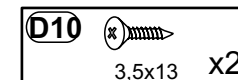
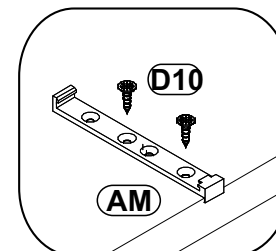
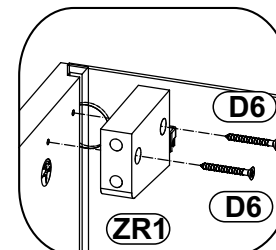
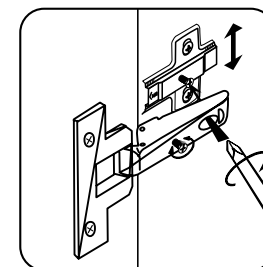
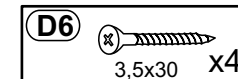
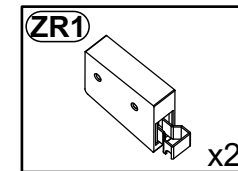
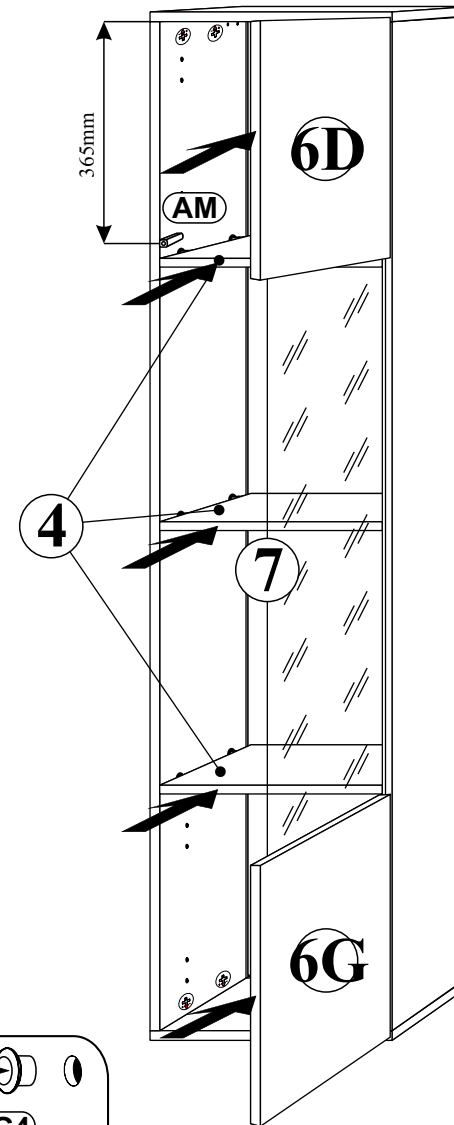
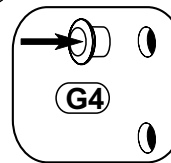
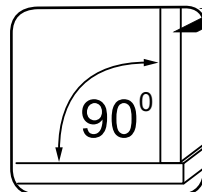
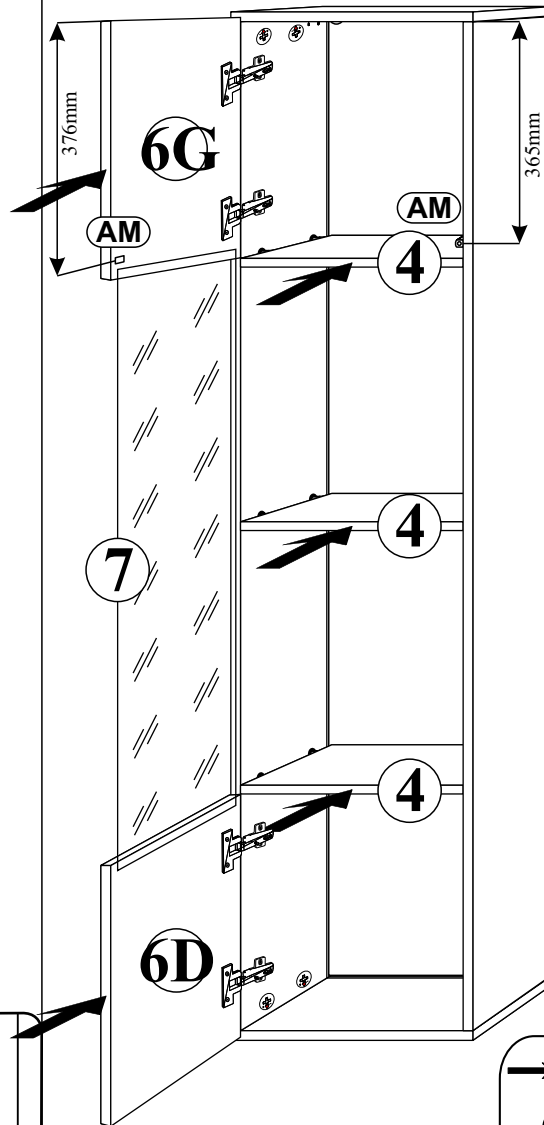
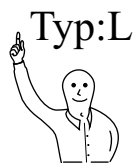

6

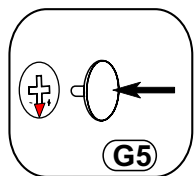
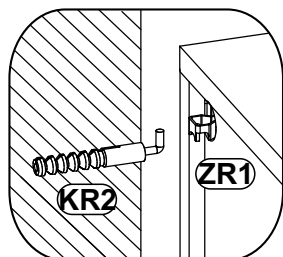
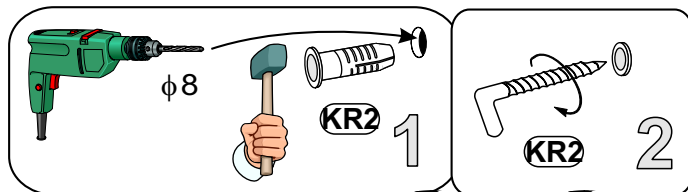

PL Złączone kołki do zawieszania bryfy, do stosowania wyłącznie do ścian betonowych, do innych ścian należy odpowiednio dokupić.

D Die beigefügten Dübel zum Aufhängen des Elements dürfen nur bei Betonwänden eingesetzt werden, bei anderen Wandarten müssen entsprechende Dübel zugekauft werden.

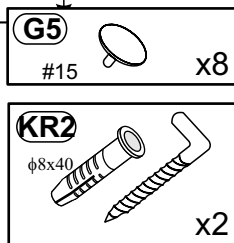
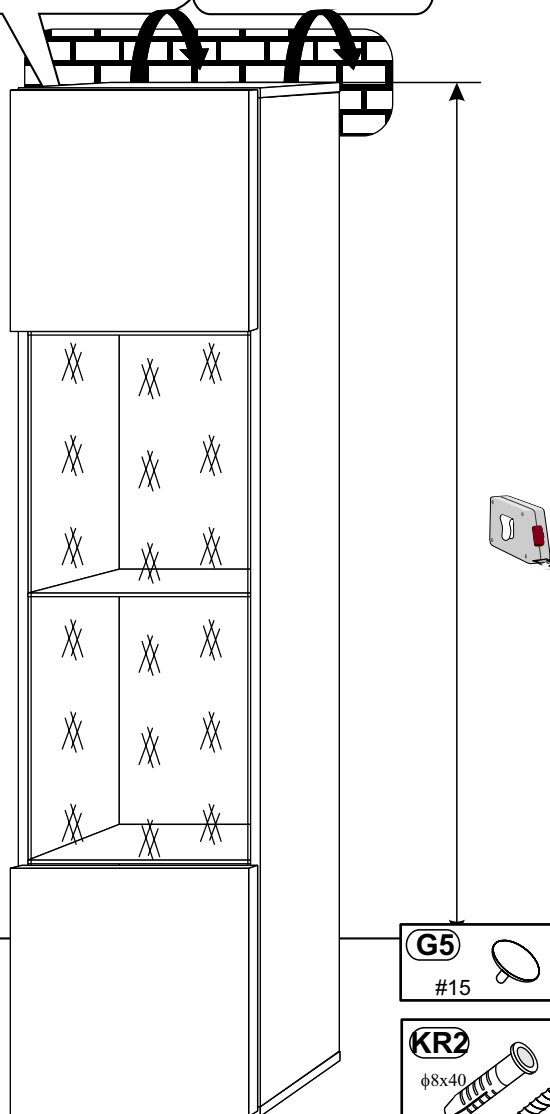

Verstellmöglichkeiten

- a) Fugenverstellung:
 Befestigungsschraube "A" lockern, gewünschte Fuge mit Schraube "B" einstellen, Schraube "A" anziehen.
- b) Tiefenverstellung:
 Befestigungsschraube "A" lockern, Bandarm nach vorne oder rückwärts verschieben, Schraube "A" anziehen, Schraube "B" mit einer 1/4 Drehung nach rechts arretieren.
- c) Höhenverstellung:
 Befestigungsschraube "C" lockern, Höhe einstellen, Schraube "C" anziehen.

Instructions for hinge adjustment

- a) Side adjustment:
 Loosen fixing screw "A", adjust gap with screw "B" and retighten screw "A".
- b) Depth adjustment:
 Loosen fixing screw "A", push hinge arm forwards or backwards, retighten screw "A", fix screw "B" with a 1/4-turn in clock-wise direction.
- c) Height adjustment:
 Loosen screw "C", adjust height, retighten screw "C".

Les possibilités de positionnement

- a) Positionnement de la rainure:
 Desserrer la vis de fixation "A", positionner avec la vis "B" la rainure (joint) souhaitée et resserrer la vis "A".
- b) Positionnement de la profondeur:
 Desserrer la vis de fixation "A" (1 tour), régler la profondeur et resserrer la vis "A".
- c) Positionnement de la hauteur:
 Desserrer la vis de fixation "C" (1 tour), positionner la hauteur et resserrer la vis "C".

Możliwości regulacji

- a) Regulacja szczeliny:
 Poluzować wkręt "A", wkrętem "B" ustawić odpowiednią szczelinę, dokręcić wkręt "A".
- b) Regulacja głębokości:
 Poluzować wkręt "A" (1 obrót), ustawić głębokość, dokręcić wkręt "A".
- c) Regulacja wysokości:
 Poluzować wkręt "C" (1 obrót), dokonać regulacji wysokości położenia drzwi, wkręt "C" dokręcić.

