

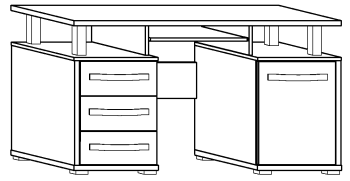

ANG-03

ANGEL- BIURKO 1D3S

-135 +77 \58



x 12 a	x 8 b	x 20 c	x 16 d	x 4 e	x 2 f
x 2 g	x 6 h	x 4 n	x 50 (3,5x16) p	x 16 (4x20) r	x 8 (4x25) s
x 12 (3,5x30) t	x 4 u	x 80 w		x 1 x	
x 4 kpl. (400 mm) i	x 8 j	x 4 186 mm k	x 4 160 mm l	x 4 m	



1 - FAZY MONTAŻU

A - OZNACZENIE ELEMENTÓW

a - OZNACZENIE AKCESORIÓW

1

x 4 c

x 4 k
186 mm

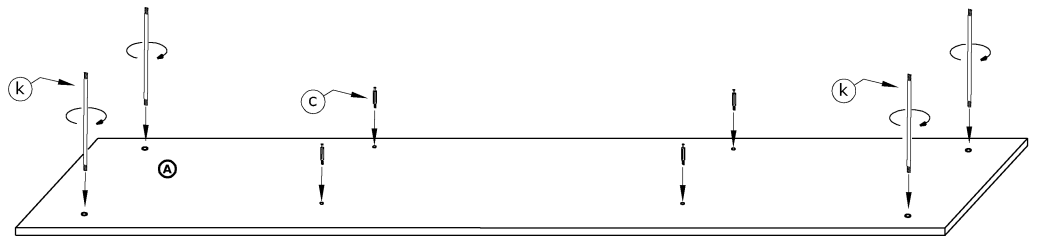

2

x 1 kpl. i

x 6 p
(3,5x16)

x 2 f

x 2 n

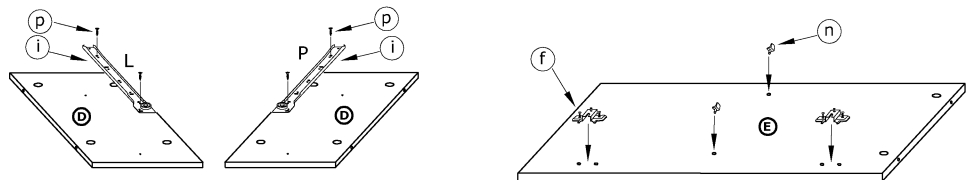

3

x 3 kpl. i

x 18 p
(3,5x16)

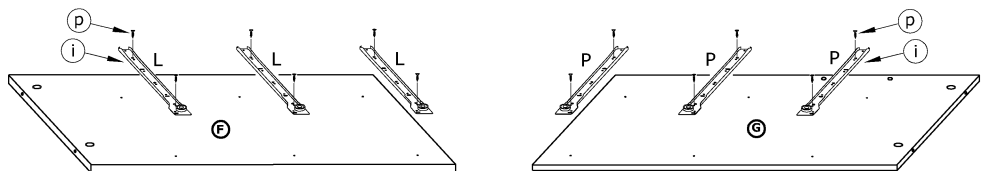



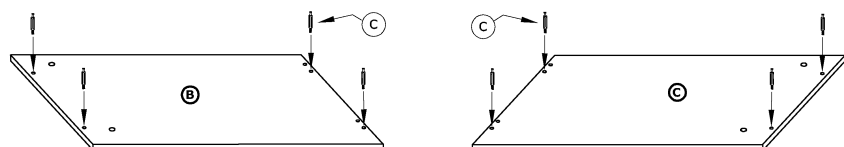

4

x 8 c





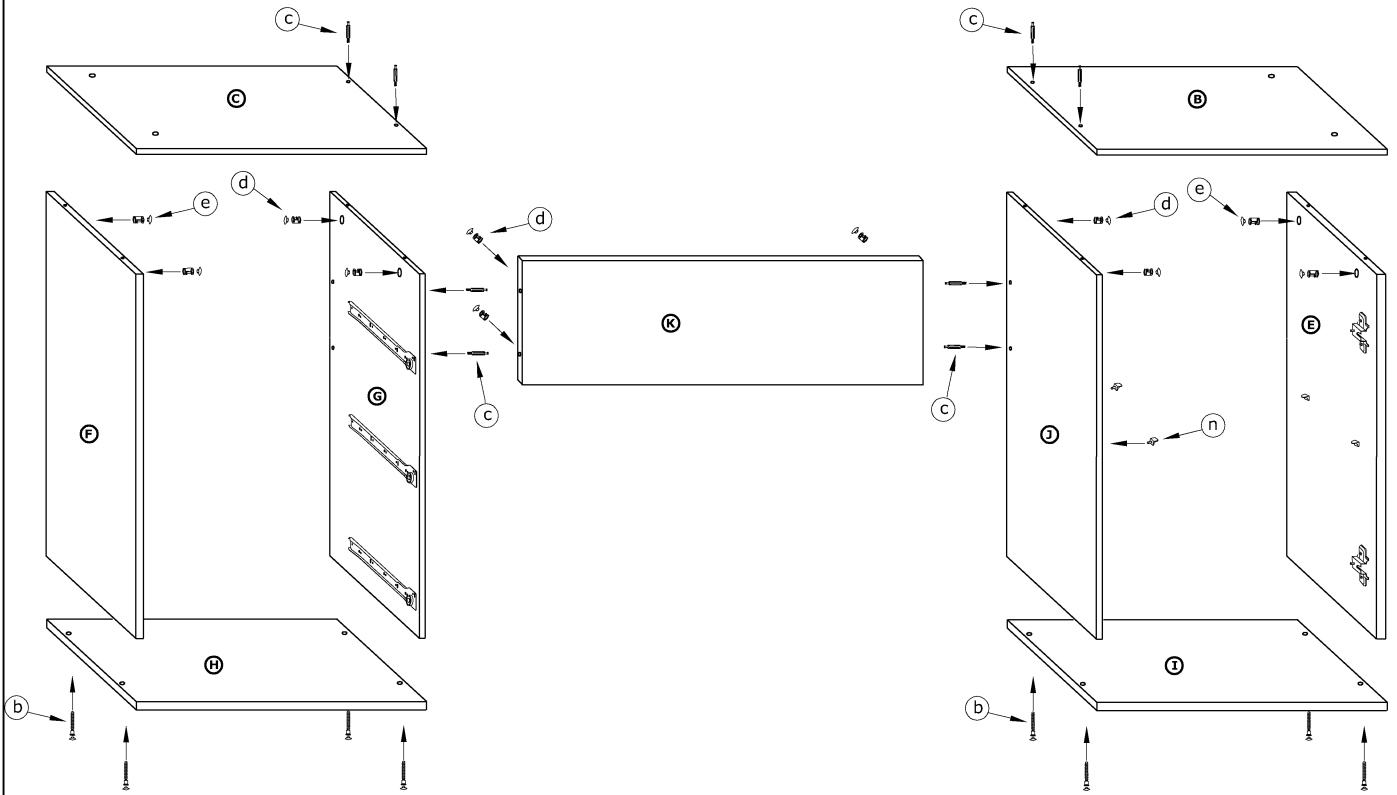

5

- x 8  (b)
- x 8  (c)
- x 8  (d)
- x 4  (e)
- x 2  (n)



6

- x 8  (d)
- x 4 160 mm  (l)
- x 8  (j)
- x 16 (4x20)  (r)
- x 4  (u)

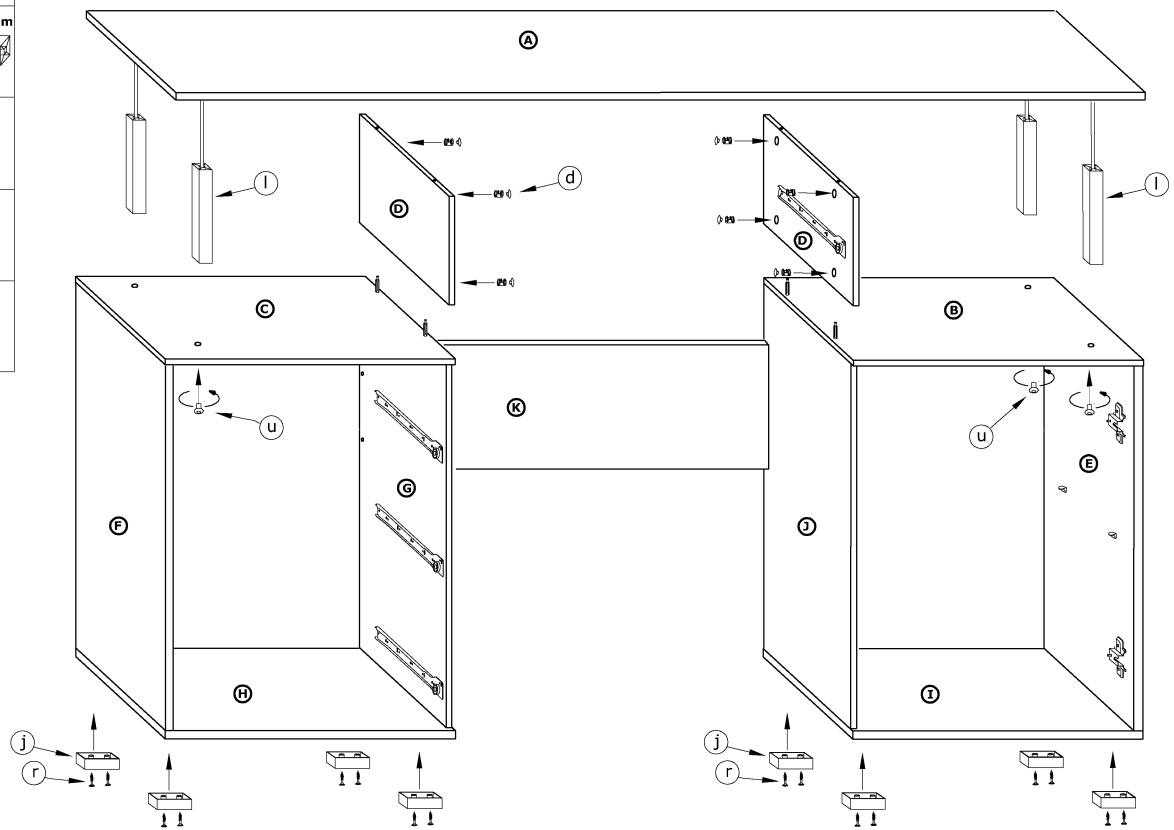

7

- x 12 (a)
- x 3 (i)
- x 3 (m)
- x 18 (3,5x16) (p)
- x 6 (4x25) (s)
- x 6 (3,5x30) (t)
- x 6 (h)
- x 30 (w)

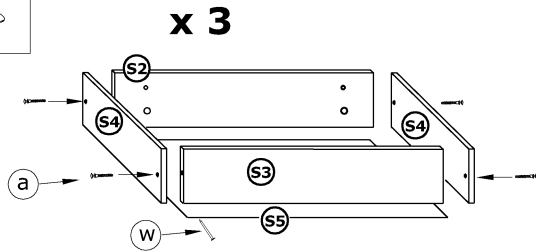

x 3

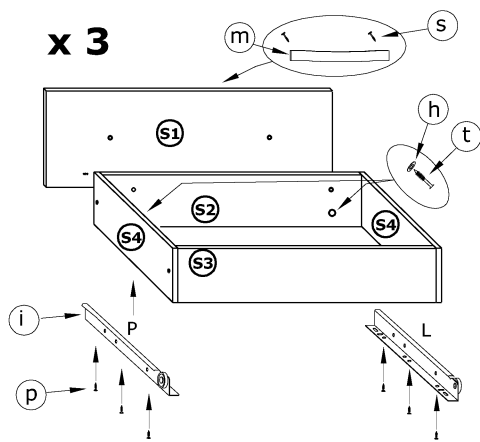

8

- x 20 (w)

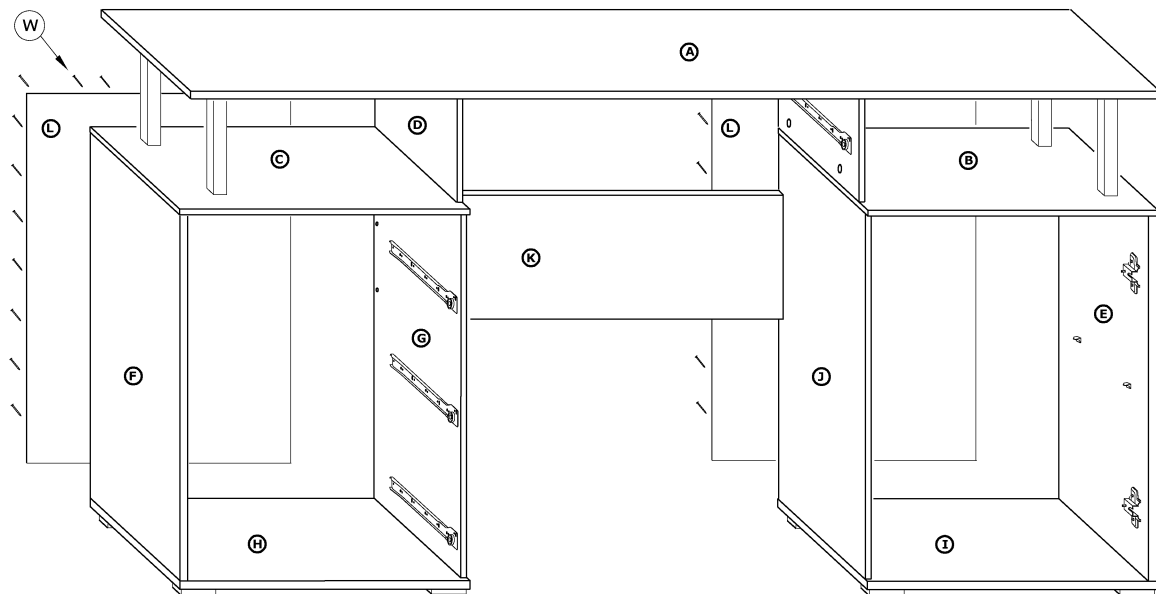

9

- x 2 (g)
- x 1 (i)
- x 1 (m)
- x 10 (3,5x16) (p)
- x 2 (4x25) (s)
- x 6 (3,5x30) (t)

