

LIVINIO 2

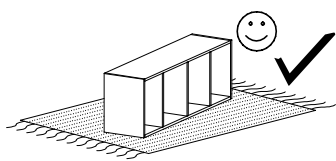

Narzędzia potrzebne do montażu

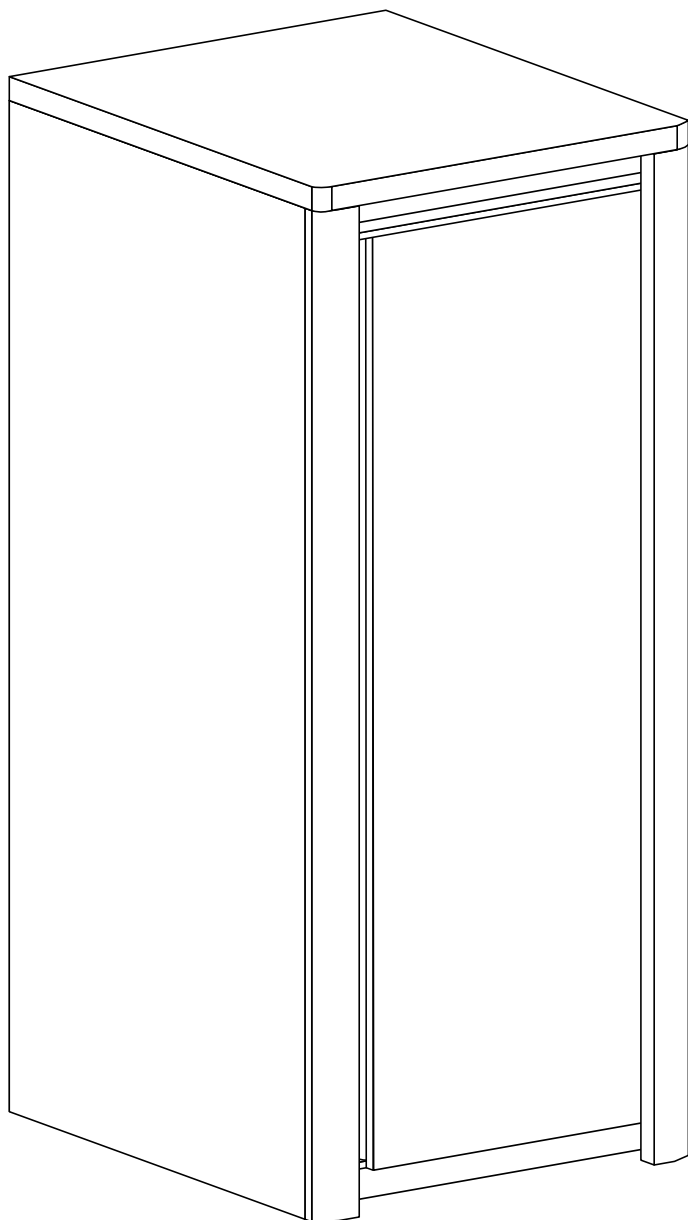

Nr	Nazwa elementu	D[mm]	S[mm]	G[mm]	Ilość
1	Bok P/L	1916	557	16	2
2	Błat Górny	726	587	48	1
3	Wieniec G/D	691	557	16	2
4	Cokół	691	80	16	2
5	Listwa Górna	691	54	16	1
6	Listwa MDF P/L	1916	80	28	2
7	Listwa MDF	1750	70	28	1
8	Kapak	1880	358	2,5	2
9	Drzwi	1795	532	16	1

UWAGA !!!

MONTOWANIE USZKODZONYCH
ELEMENTÓW POWODUJE UTRATĘ
GWARANCJI

W przypadku reklamacji proszę podać numer pakowacza znajdujący się na kartonie.

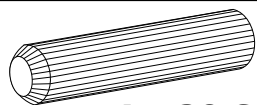

A - 30 St.

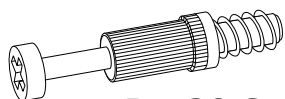

B - 20 St.

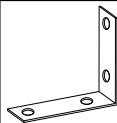

Y1 - 1 St.

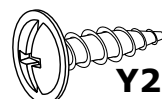

Y2 - 2 St.
3,5x16 mm



X1 - 24 St.

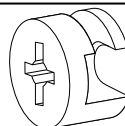

C - 20 St.

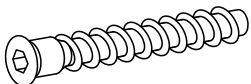

D - 6 St.

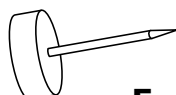

E - 4 St.

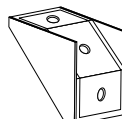

F - 4 St.

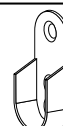

H - 2 St.

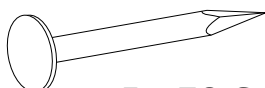

I - 50 St.

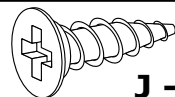

J - 20 St.
3,5x16 mm

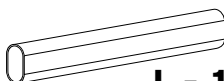

L - 1 St.
638 mm

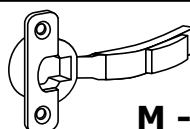

M - 4 St.

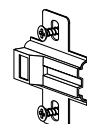

N - 4 St.

I

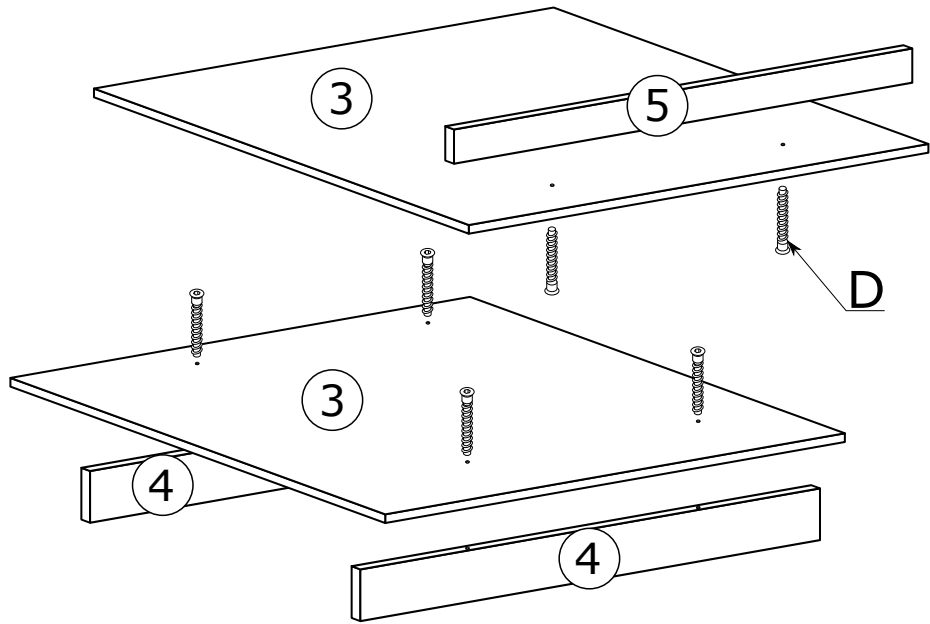

II

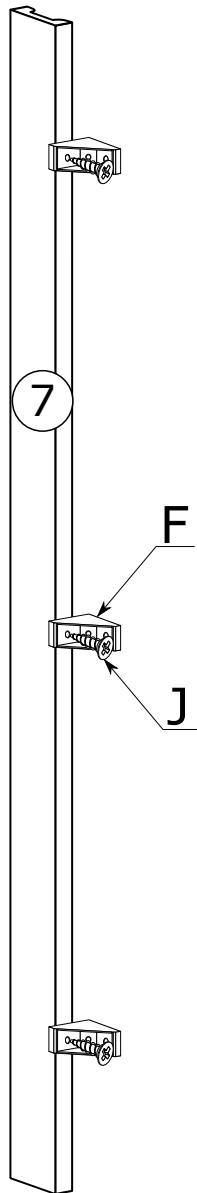

III

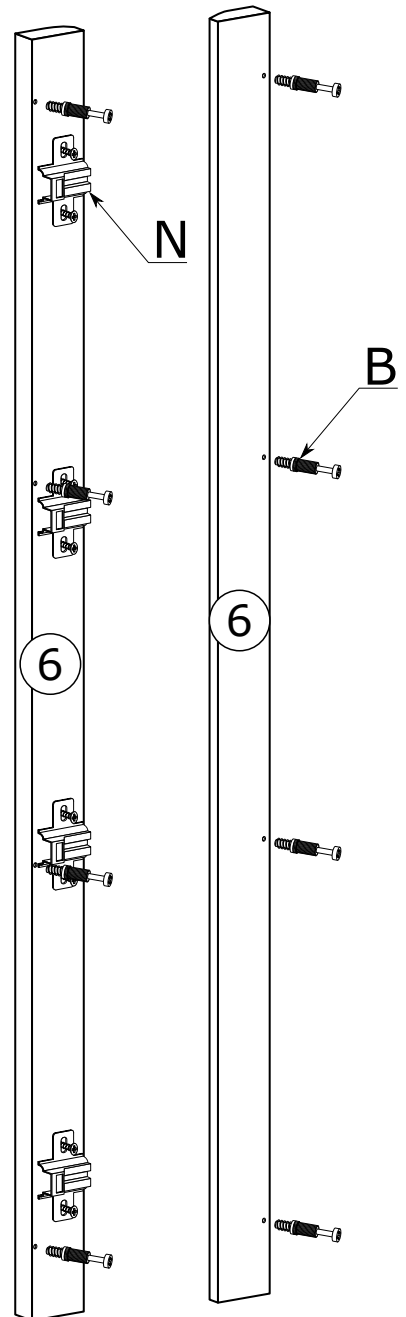

IV

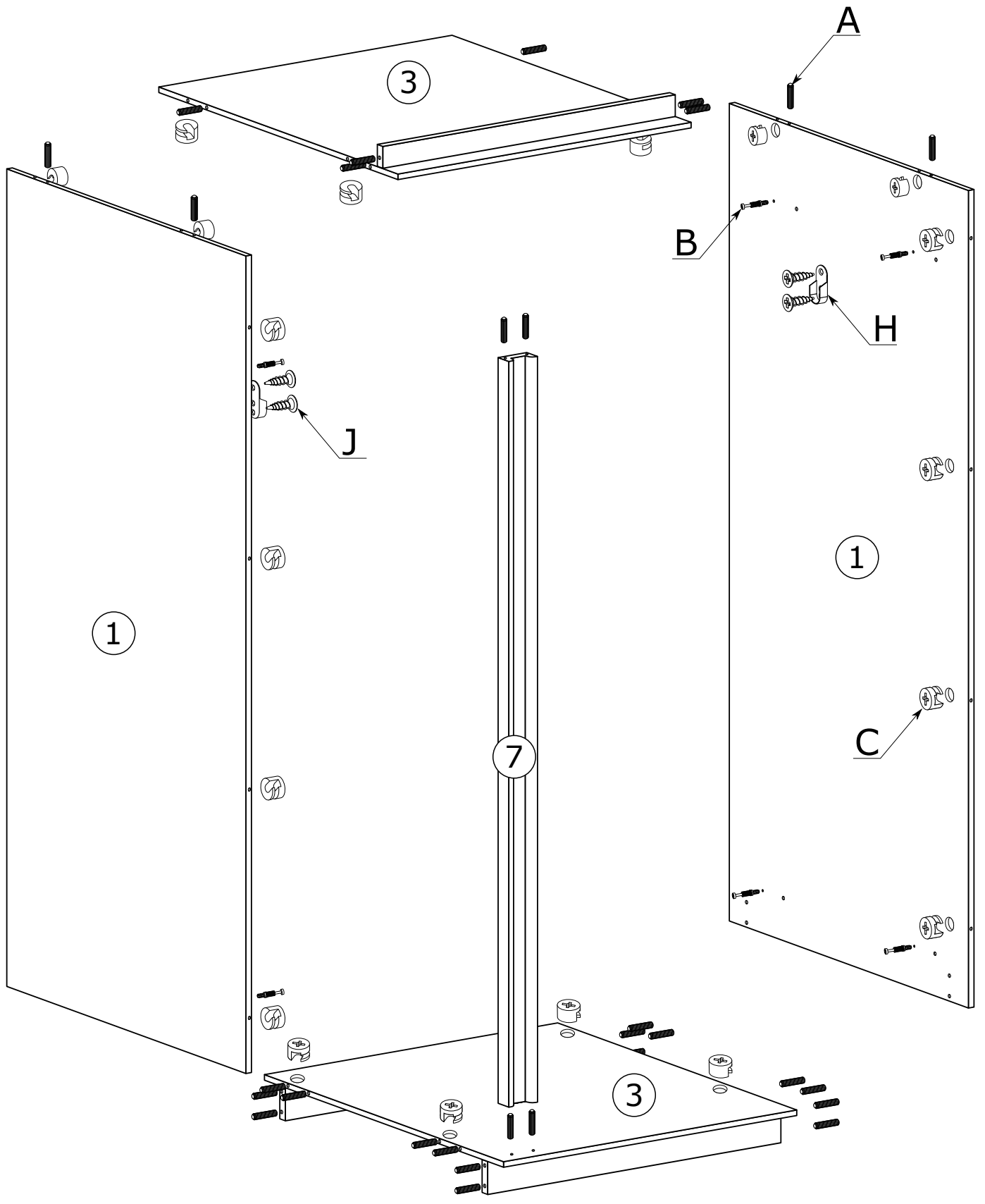

V

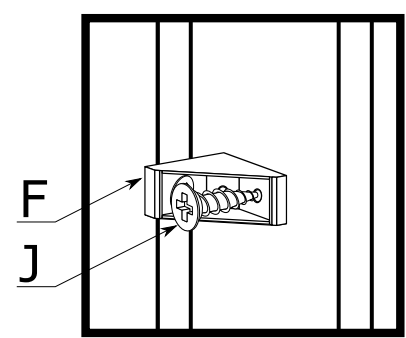
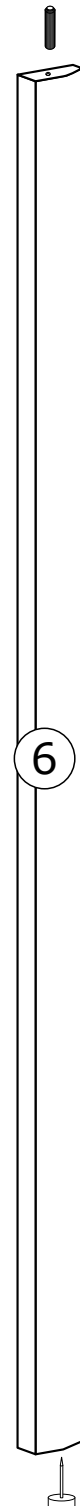
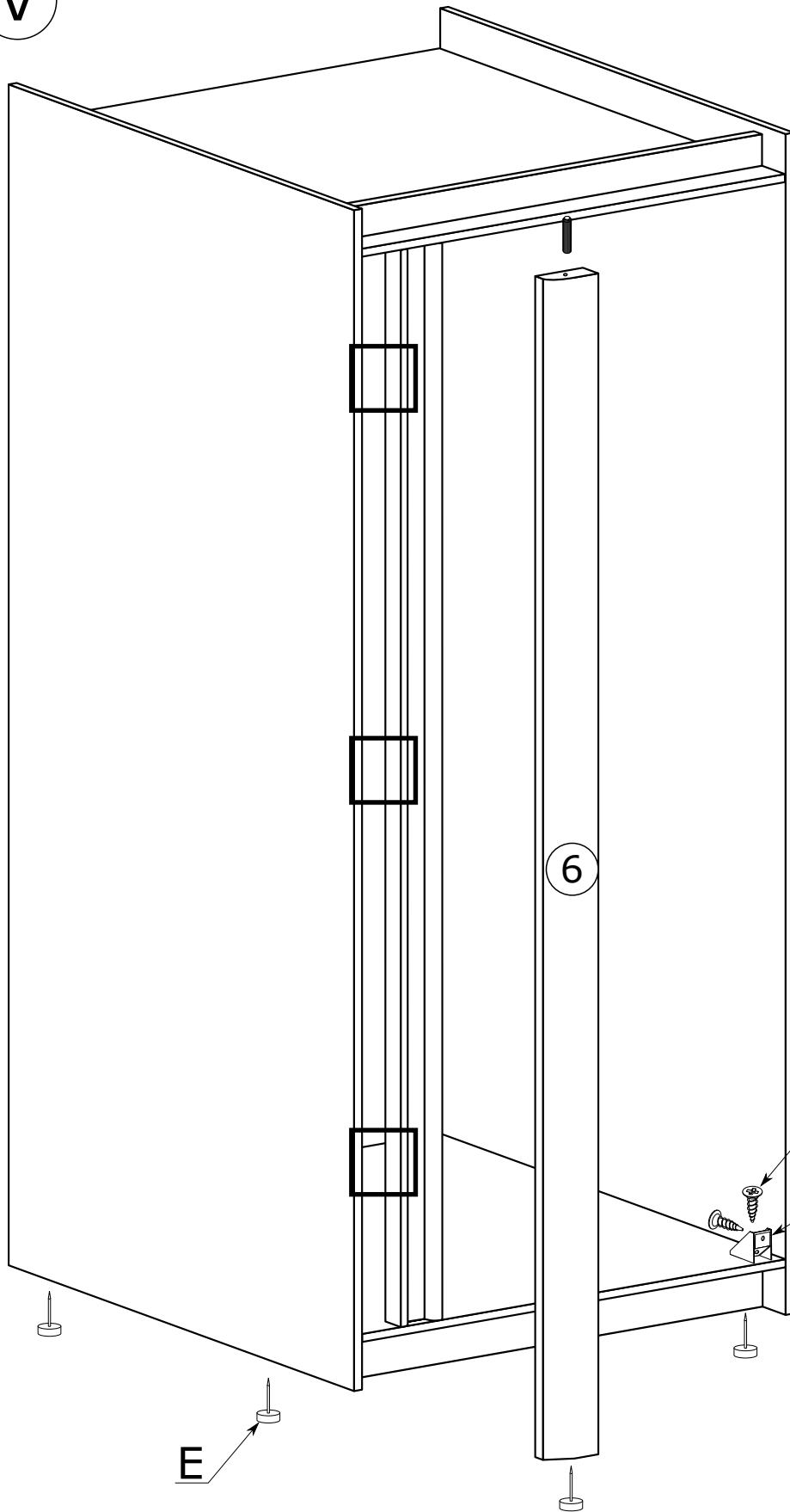

VI

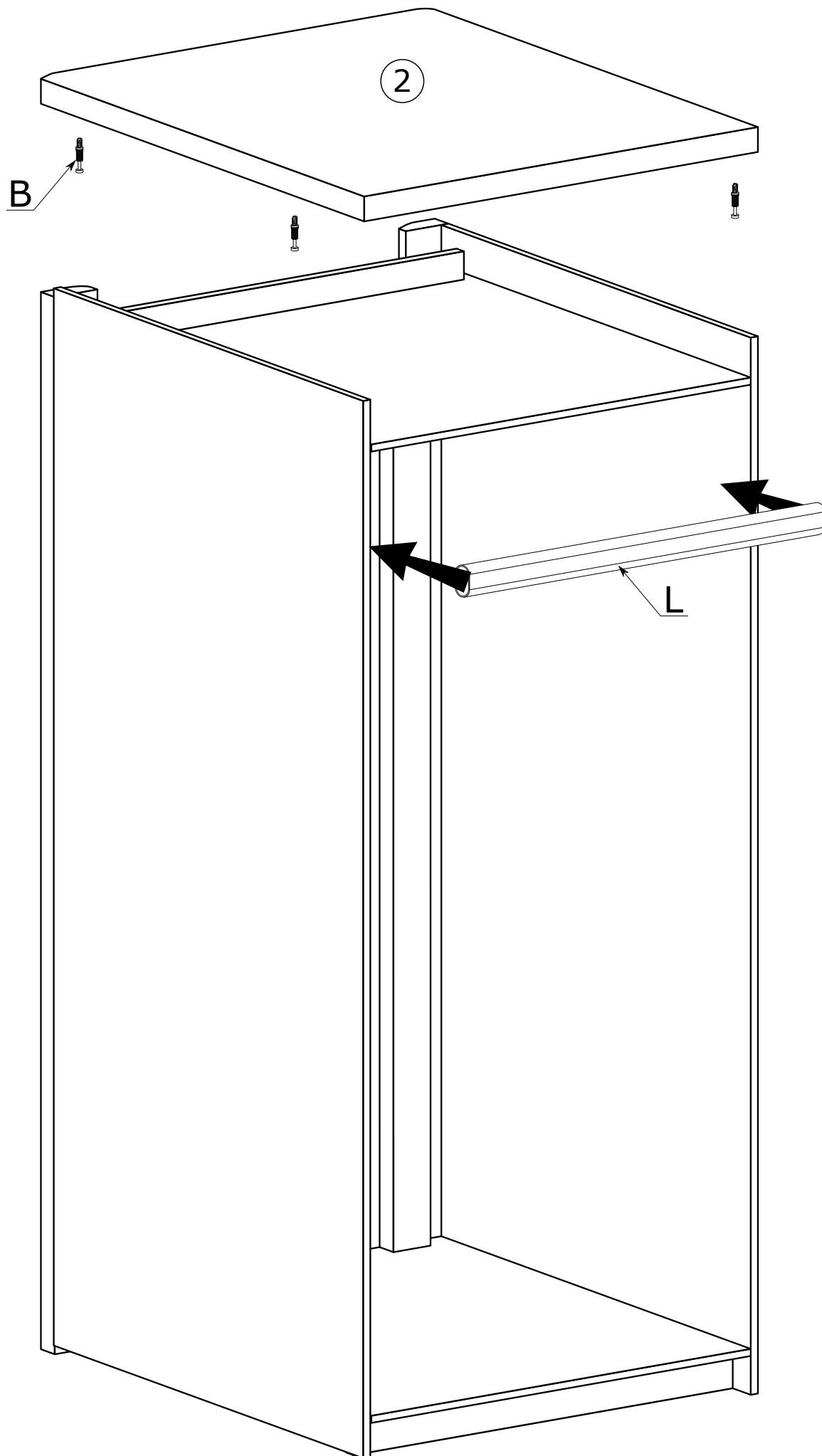

VII

x50

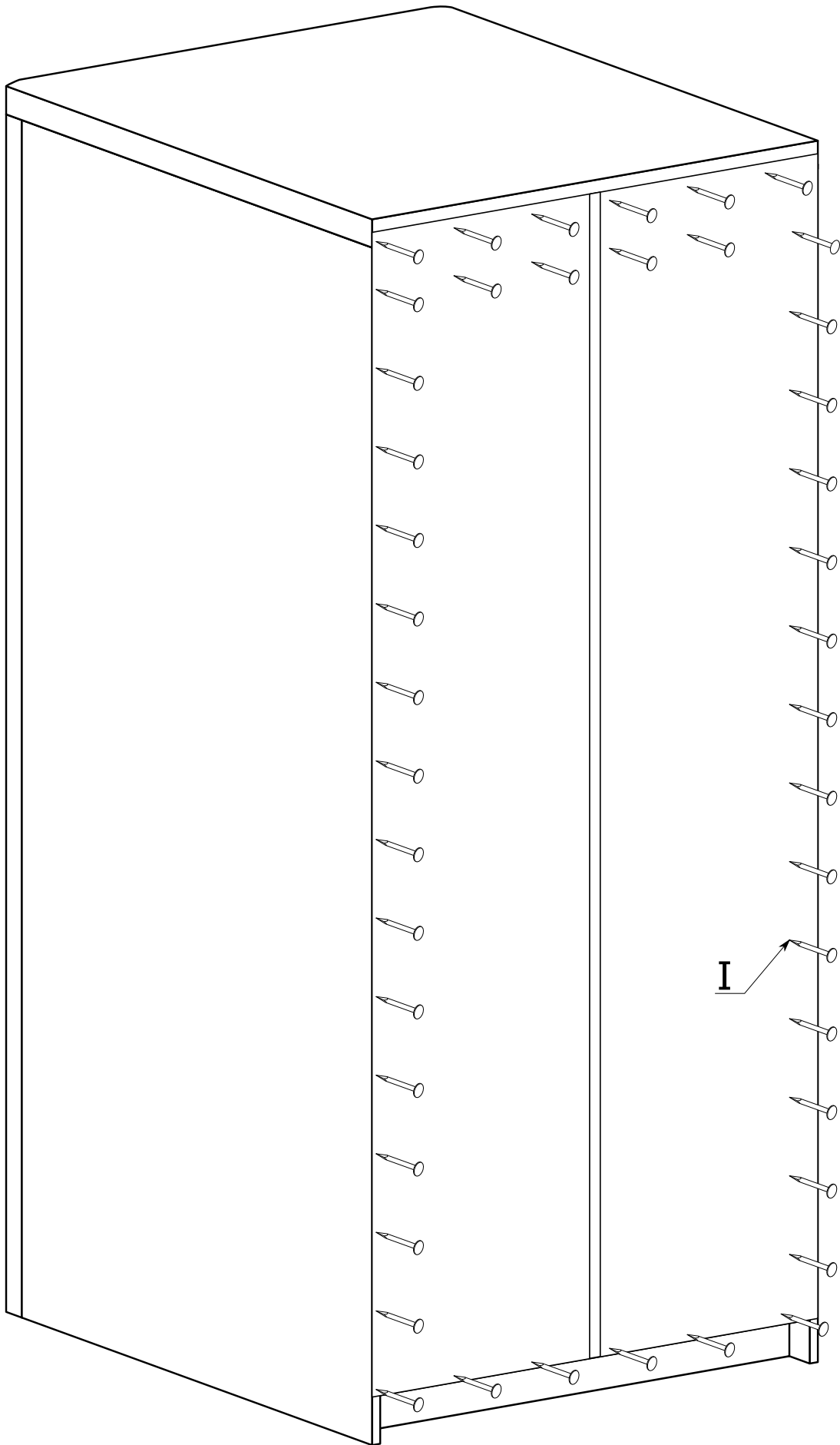
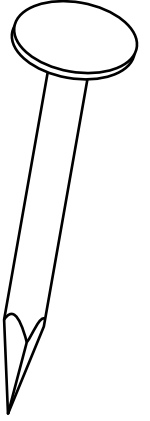

A = B

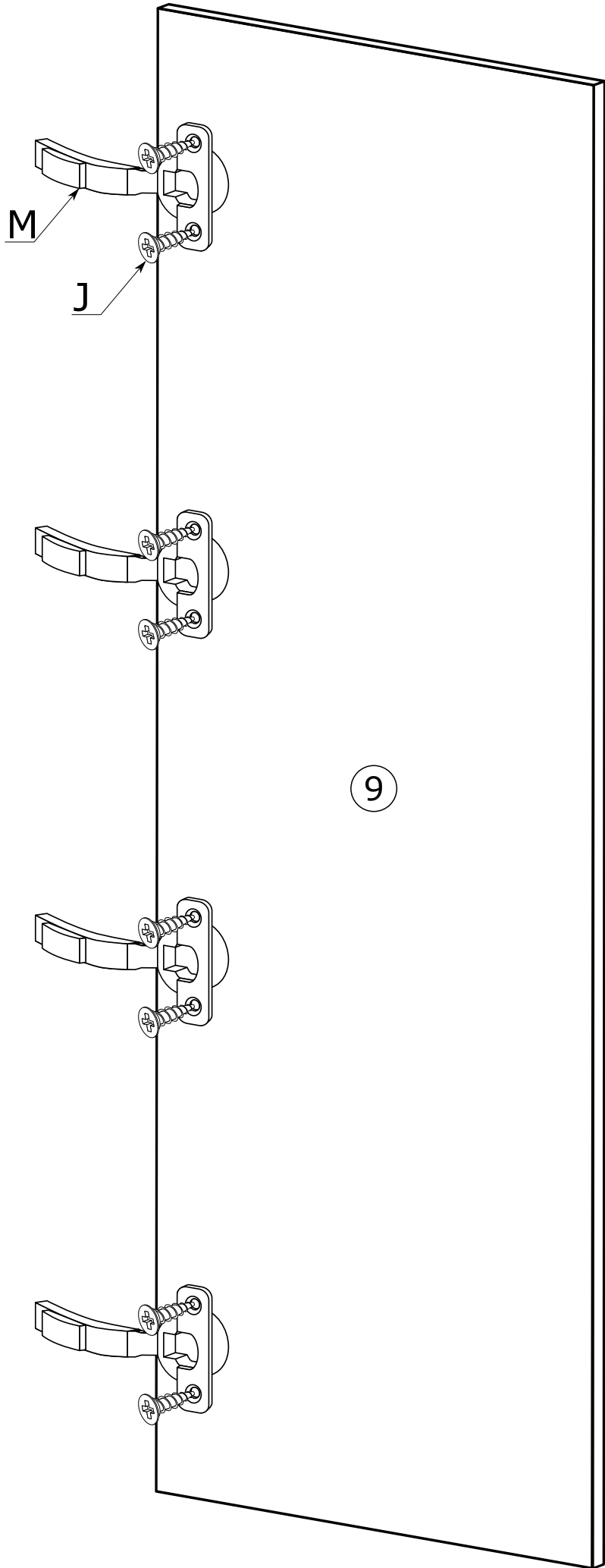

IX

