

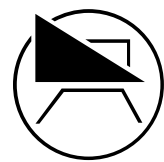

Narožnik BRICO Mini Corner sofa BRICO Mini

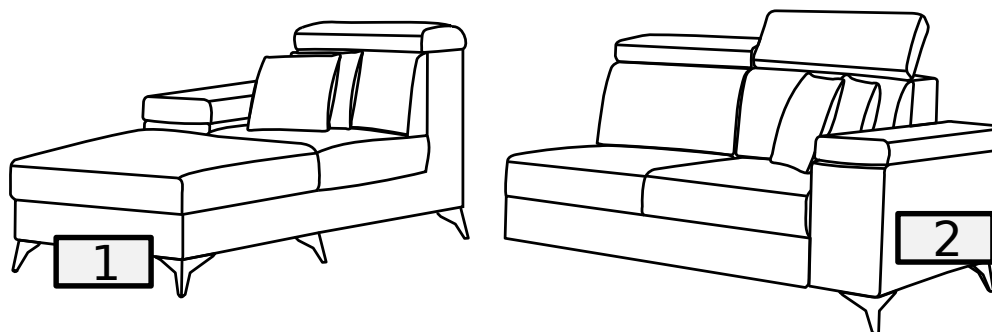

INSTRUKCJA MONTAŻU • ASSEMBLY INSTRUCTION • MONTAGEANLEITUNG

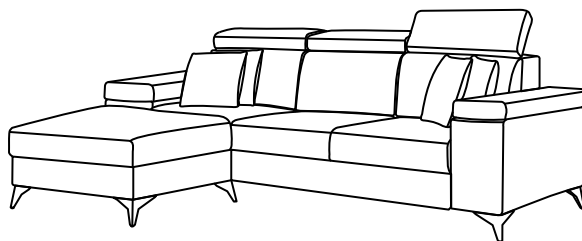

①

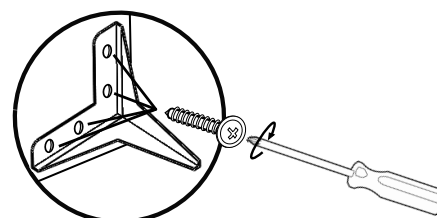
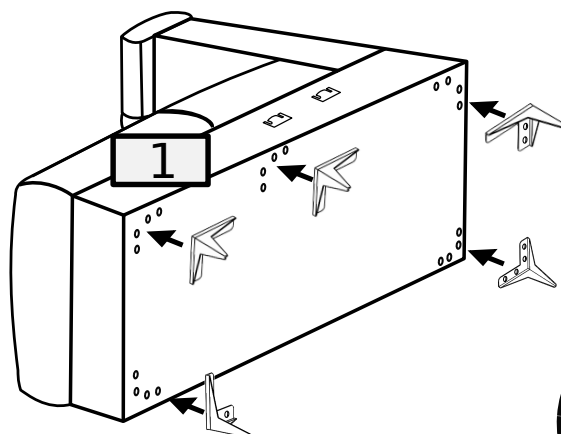
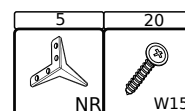

2

2	8	4	2
NR	W15	W16	ND

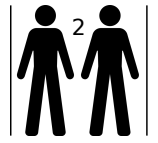
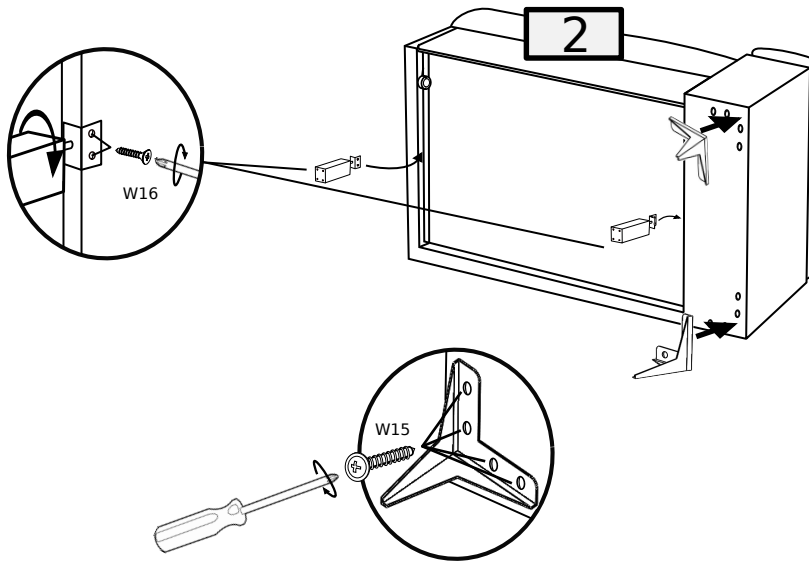

3

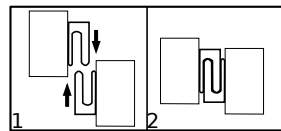
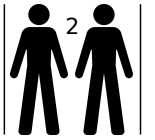
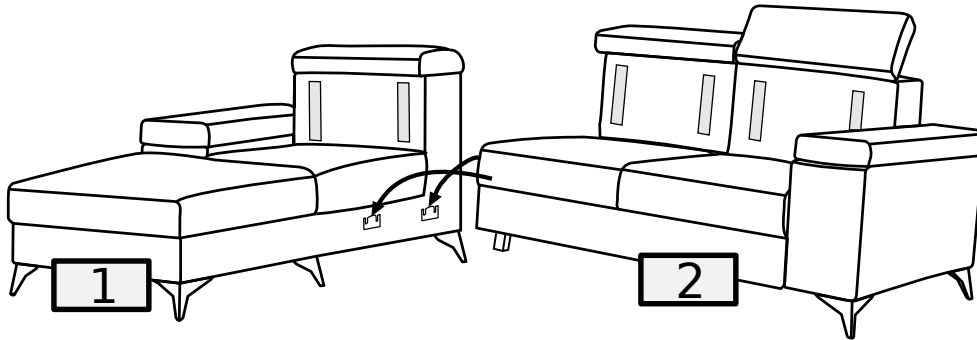

4

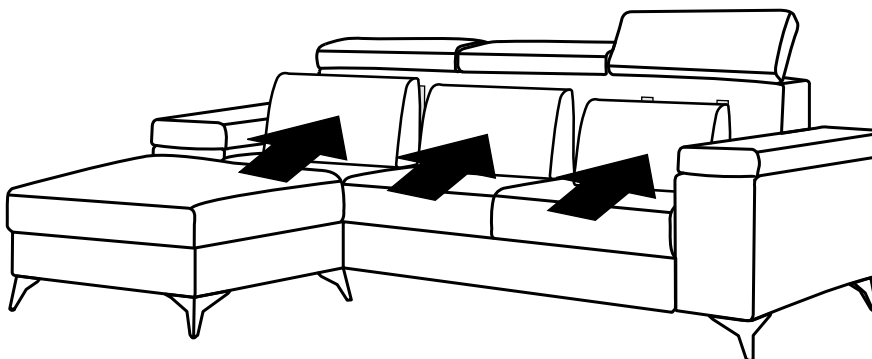

5

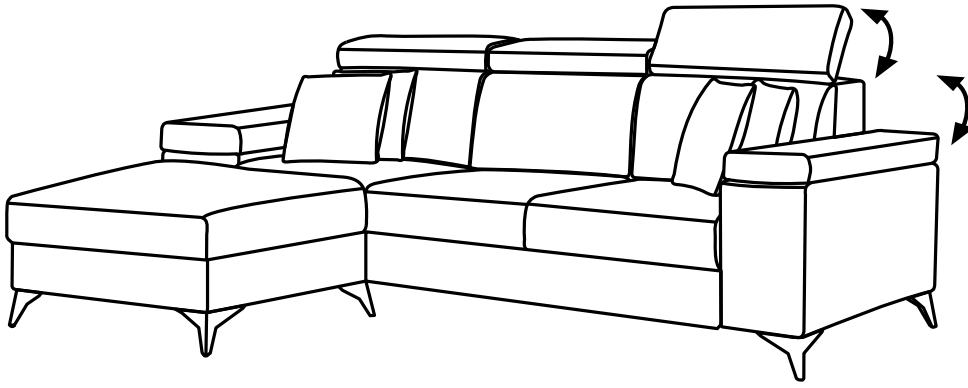

0

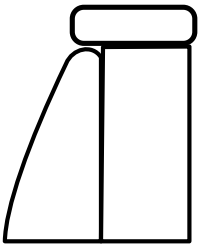

1

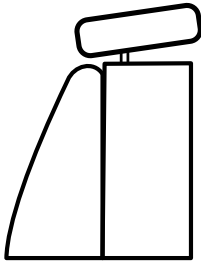

2

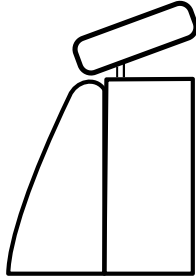

3

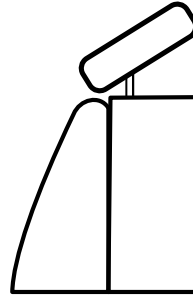

4

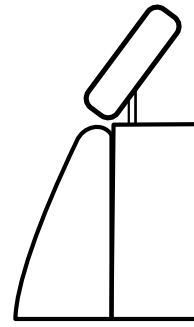

5

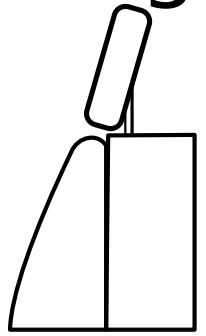

6

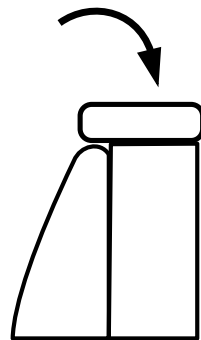
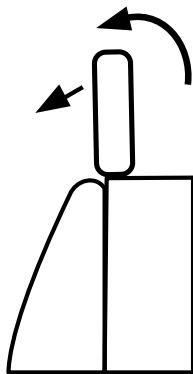

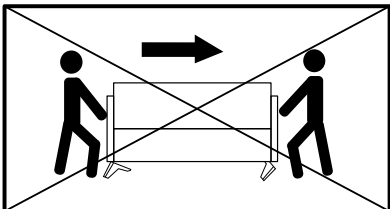
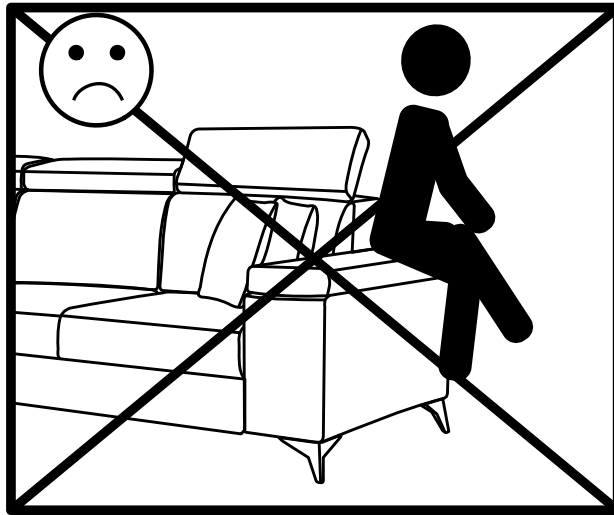

×

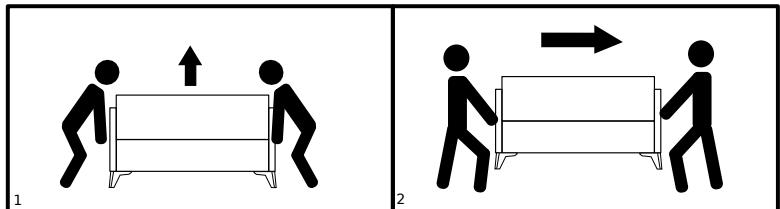

✓