

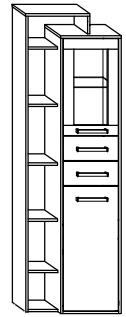

# RIO-27 WITRYNA L1D2S

→ 64 + 203 \ 41



x 14 	x 28 	x 28 	x 22 	x 4 	x 4 		
x 14 	x 6 	x 4 	x 32 (3,5x16) 	x 8 (3,5x30) 	x 4 	x 70 	x 1 
x 2 kpl. (350 mm) 						 60 min 	

**1** - FAZY MONTAŻU

**A** - OZNACZENIE ELEMENTÓW

**a** - OZNACZENIE AKCESORIÓW

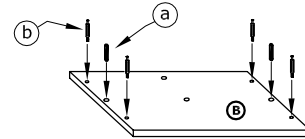
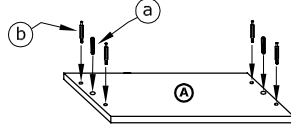
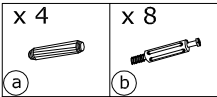

**1**

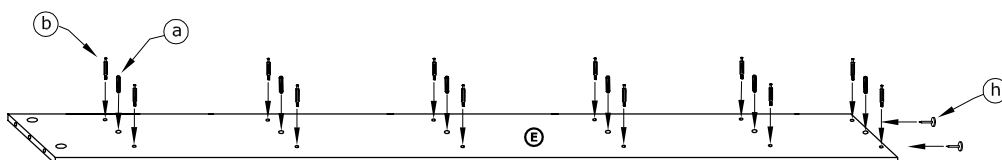
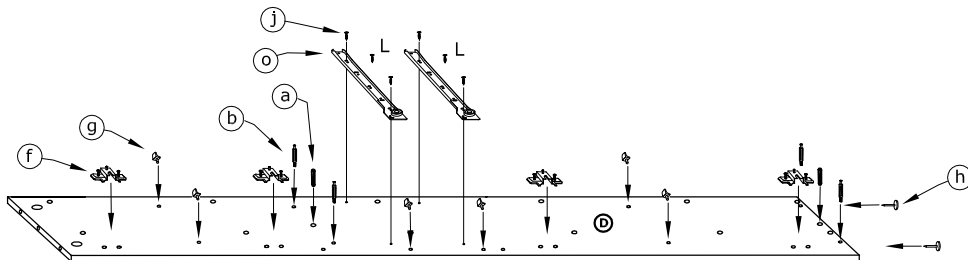
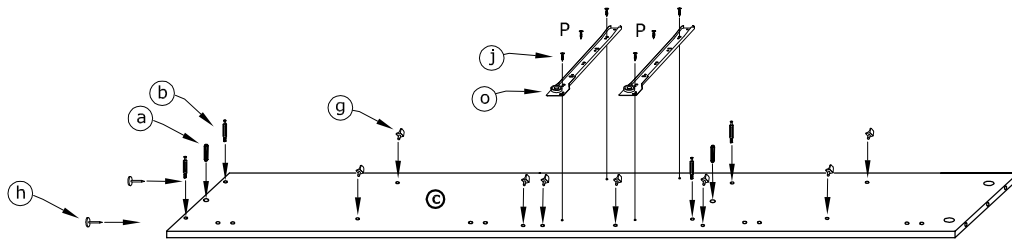
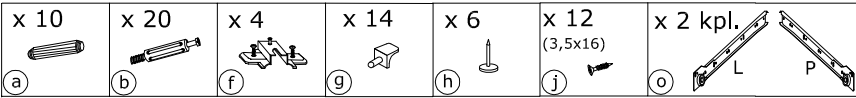

**2**



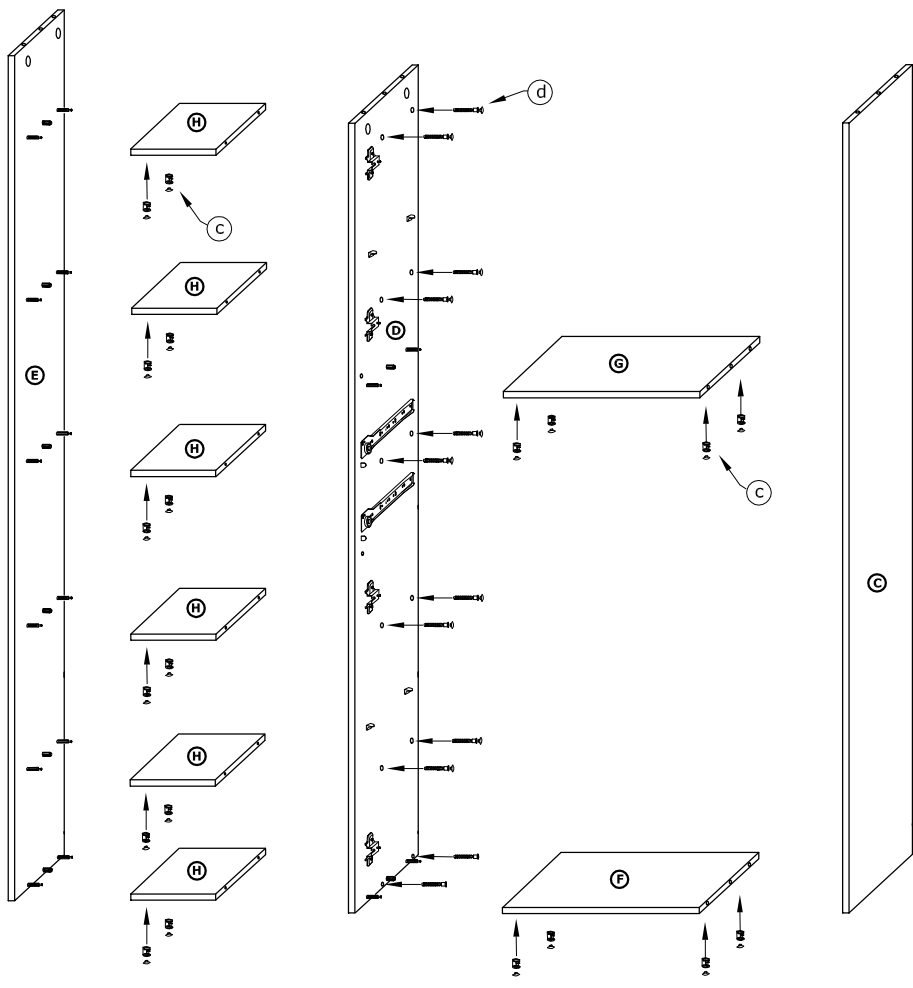

3

- x 20
- (c) 
- x 12
- (d) 



4

- x 8
- (c) 
- x 2
- (d) 

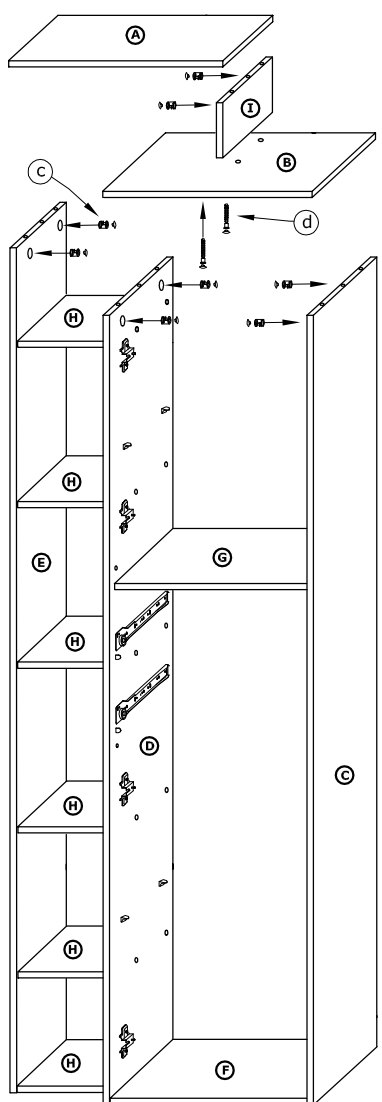

5

x 40

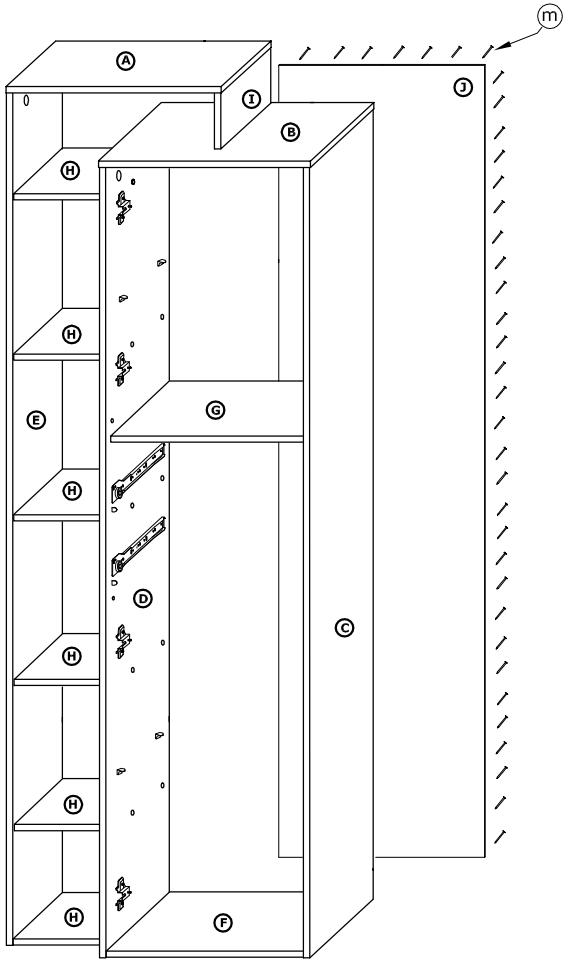

6

x 8 d	x 4 i	x 12 (3,5x16) j	x 4 (3,5x30) k
x 2 l	x 30 m	x 2 kpl. o	

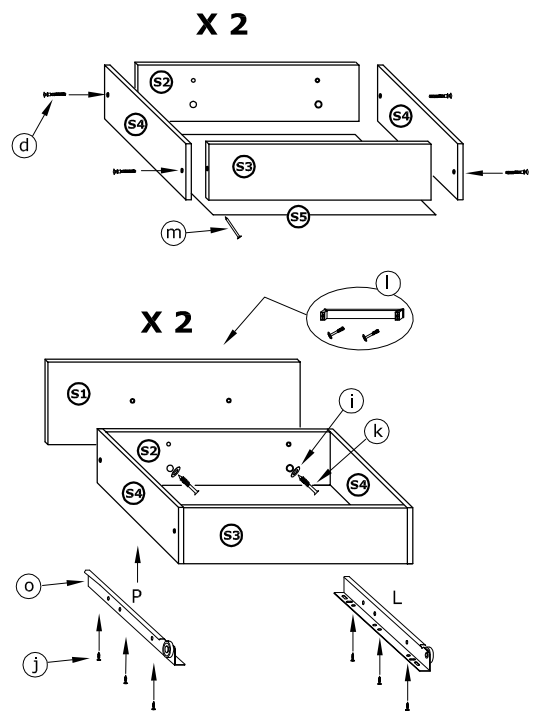

7

x 4

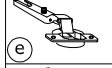

x 8  
(3,5x16)

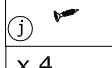

x 4  
(3,5x30)

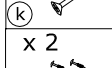

x 2

