

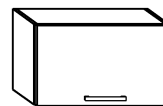

# POLO - W600K

→60 ↑ 36 ↘34



x 8



x 2

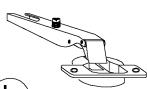

x 2

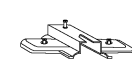

x 1



(a)

(b)

(c)

(d)

x 4



x 4 (4x16)



x 4 (3,5x30)



(e)

(f)

(g)

x 15



x 1



x 1

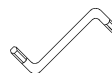

(h)

(i)

(j)

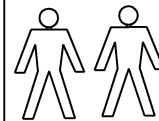

25 min

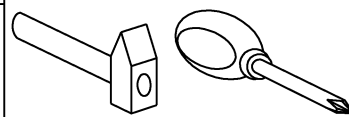
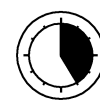

1 - FAZY MONTAŻU

A - OZNACZENIE ELEMENTÓW

a - OZNACZENIE AKCESORIÓW

1



2

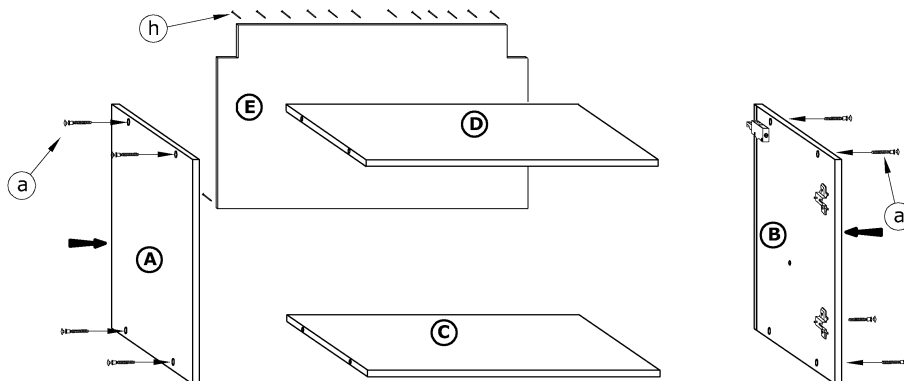

3

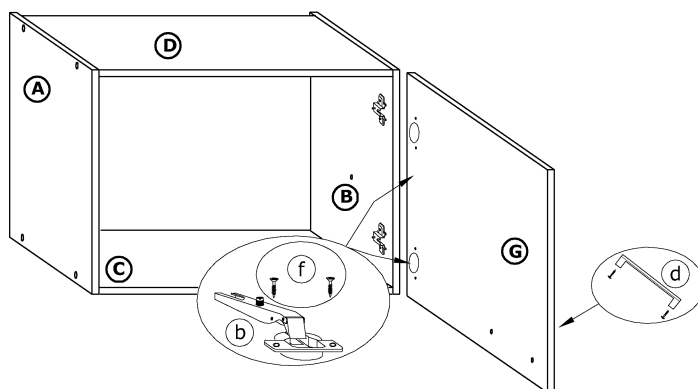

4

