

⊙ 10 cm - x 16

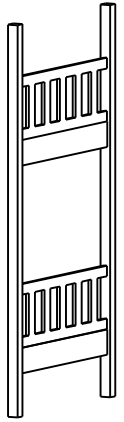

x 1

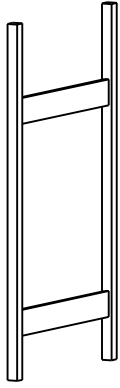

x 1

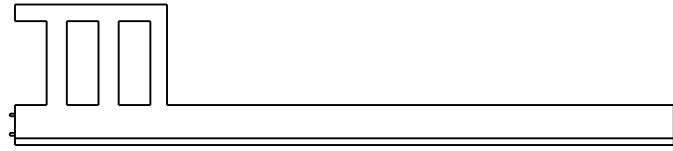

x 1

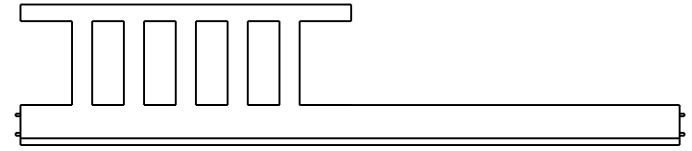

x 1

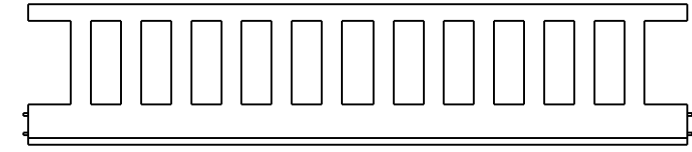

x 2



x 1

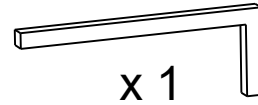

x 1

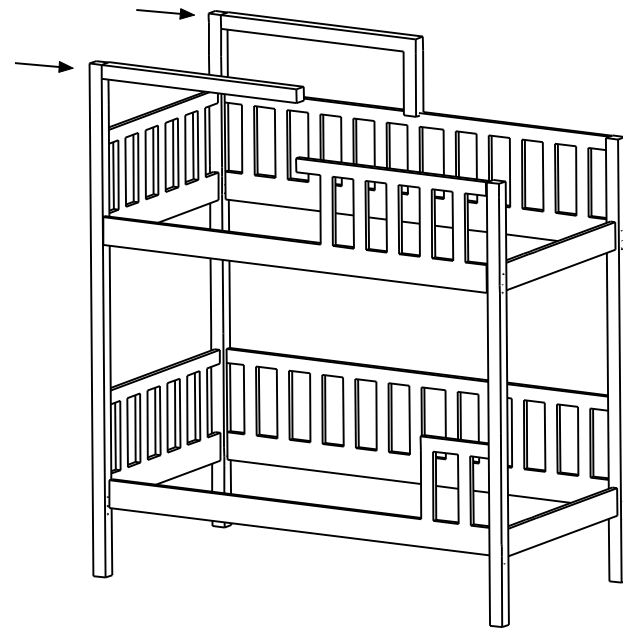
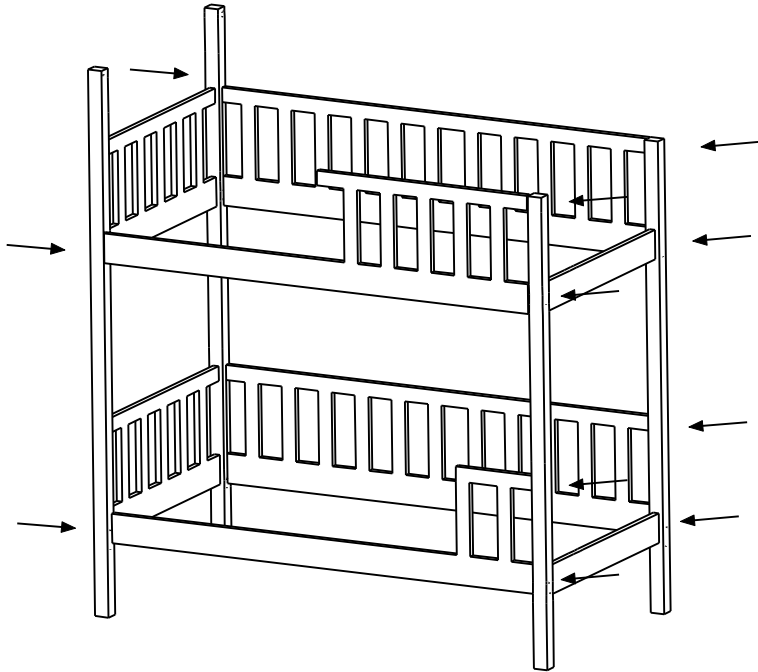

I  10 cm - x 2

II  3,5 cm - x 24

III  1,6 cm - x 6

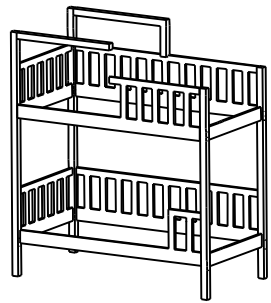

x 1

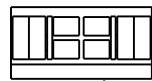

x 1

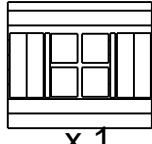

x 1

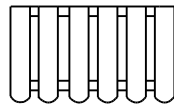

x 2



x 2



x 1

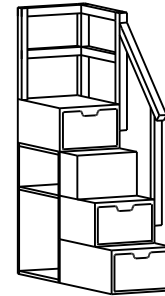

x 1

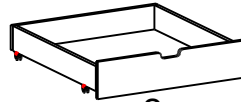

x 2



x 2

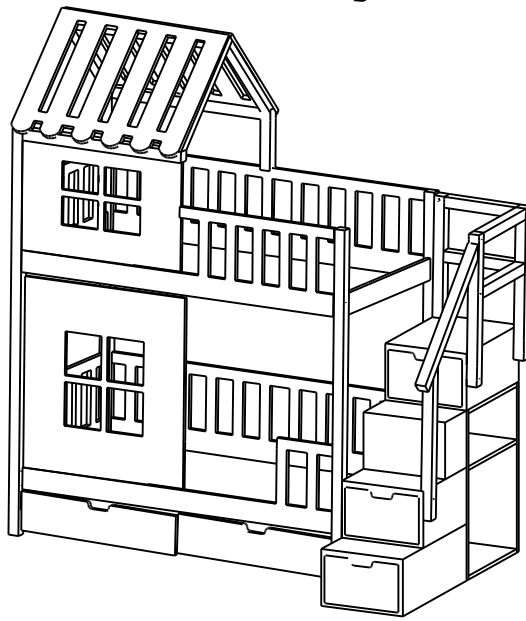
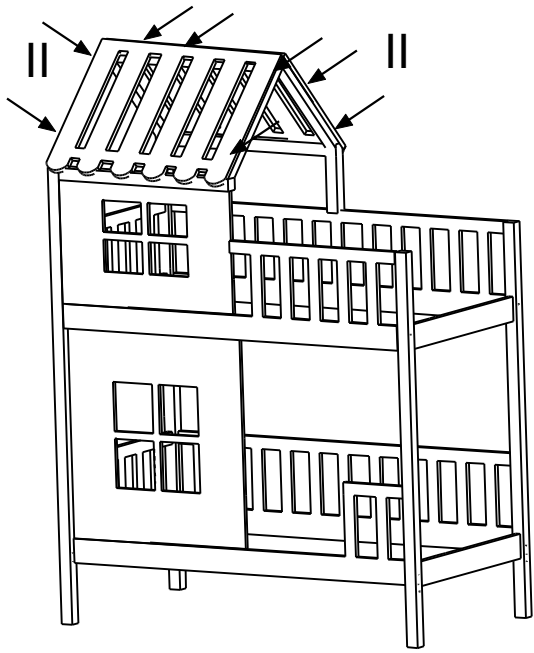
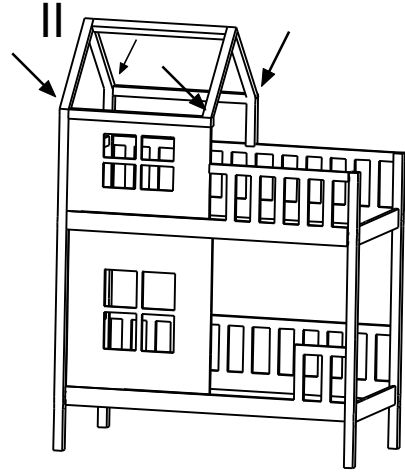
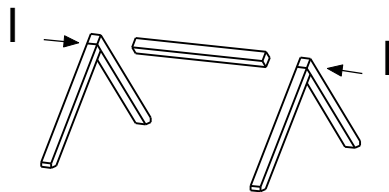
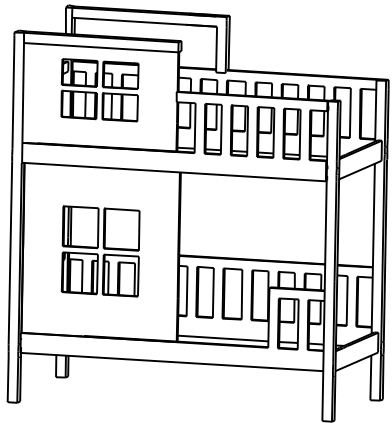

I    Ⓞ    10 cm - x 2

II    Ⓞ    6 cm - x 8

III    ⊕    3,5 cm - x 3

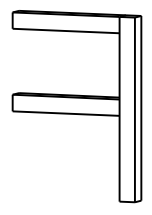
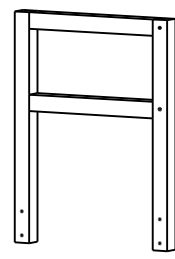
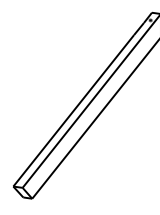

R

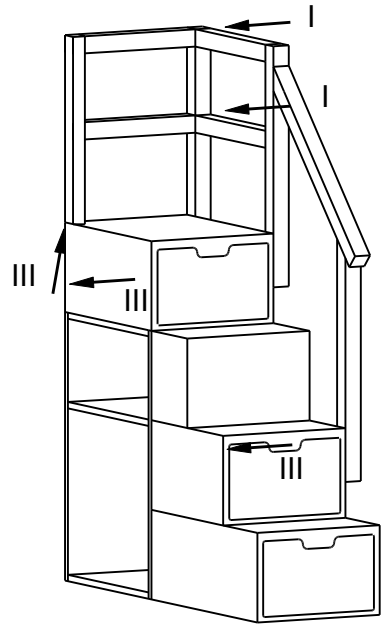
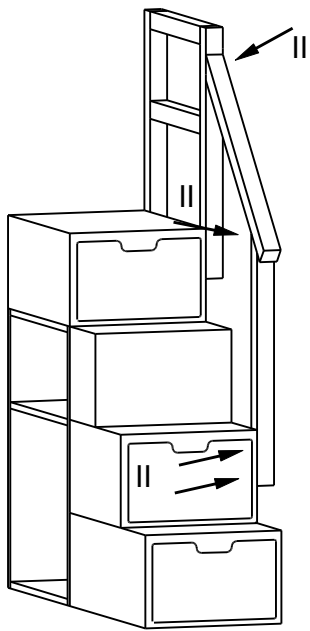
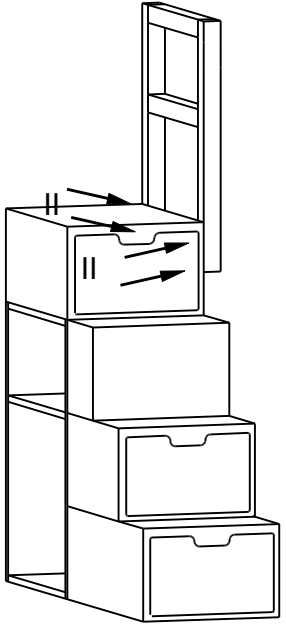

L

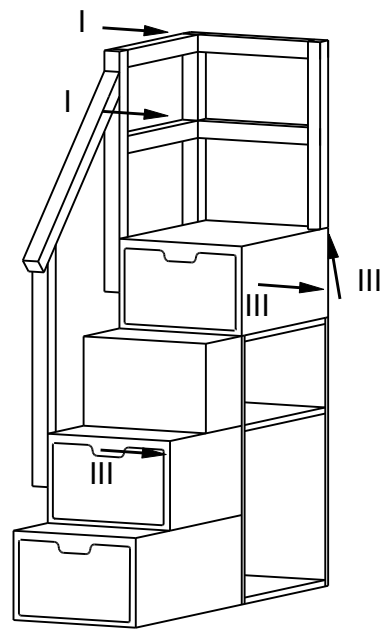
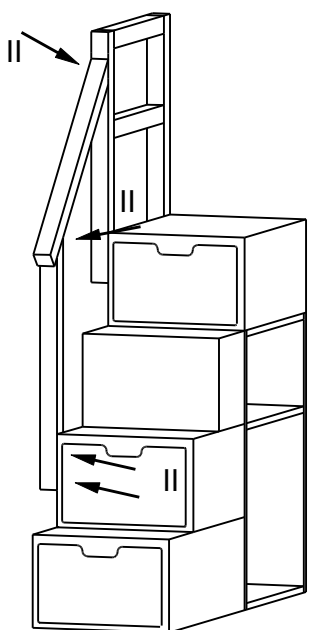
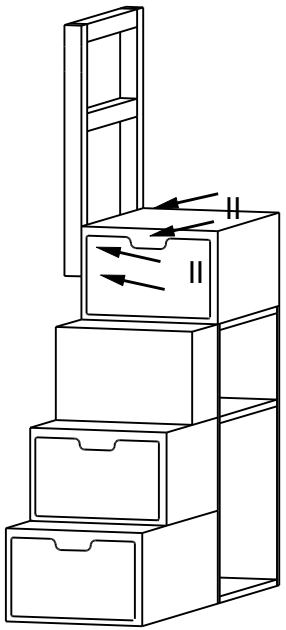

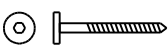
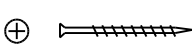
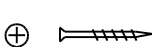
- I  6 cm - x 8
- II  2,5 cm - x 30
- III  1,6 cm - x 16

