

BR 120 S115 W75 G55

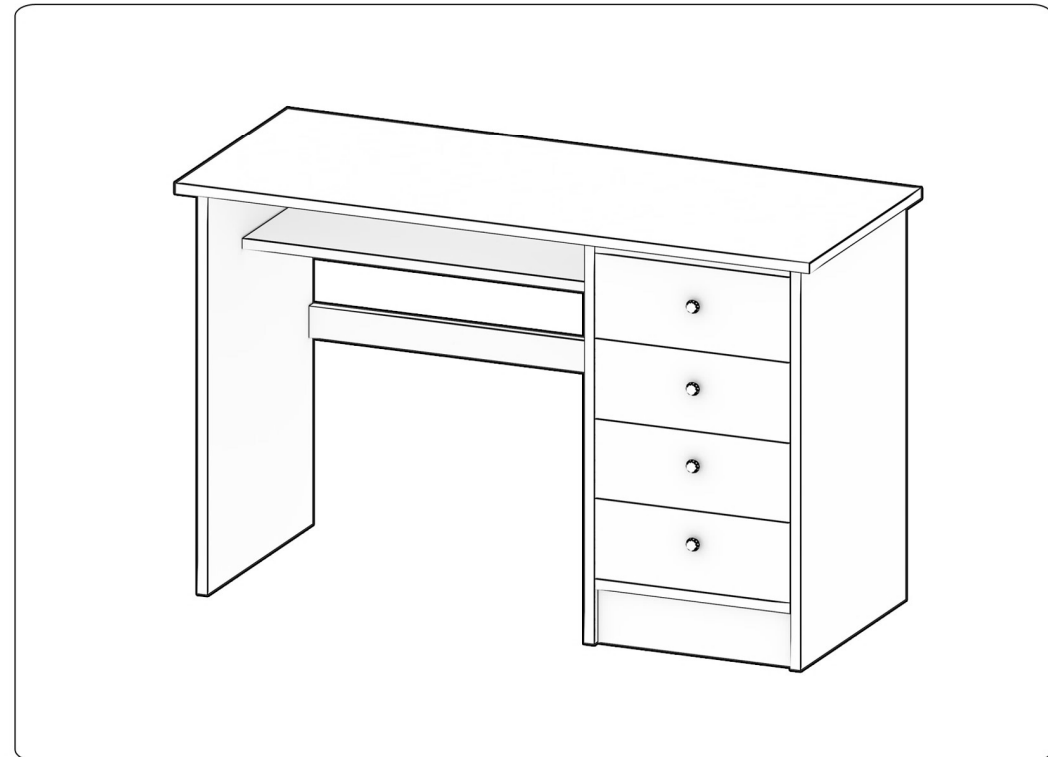

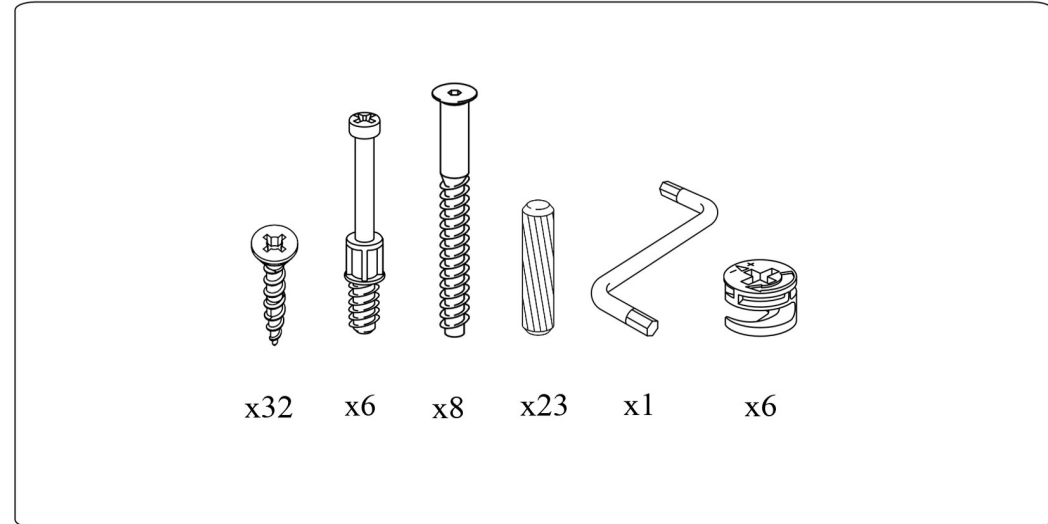

SZUFLADA

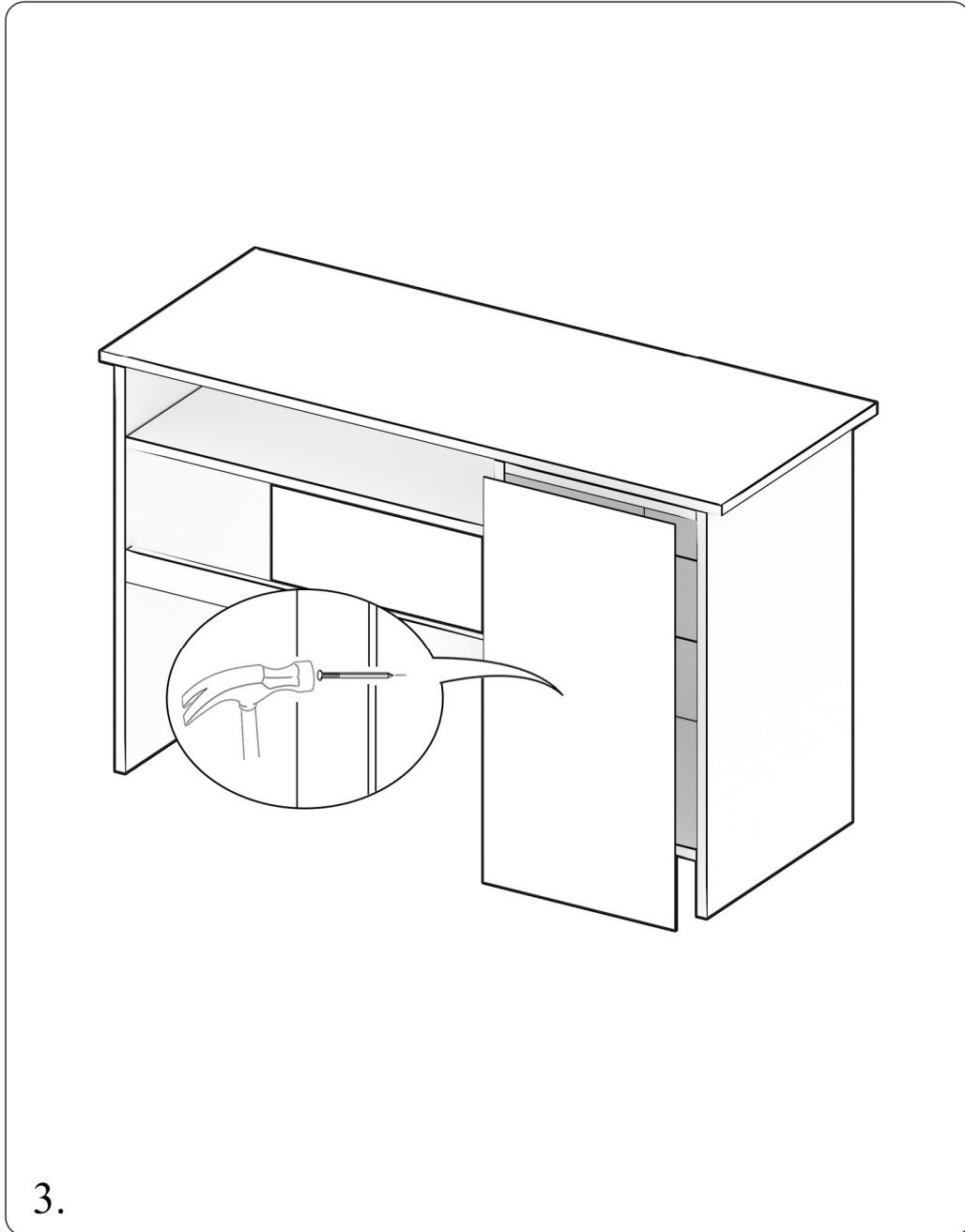
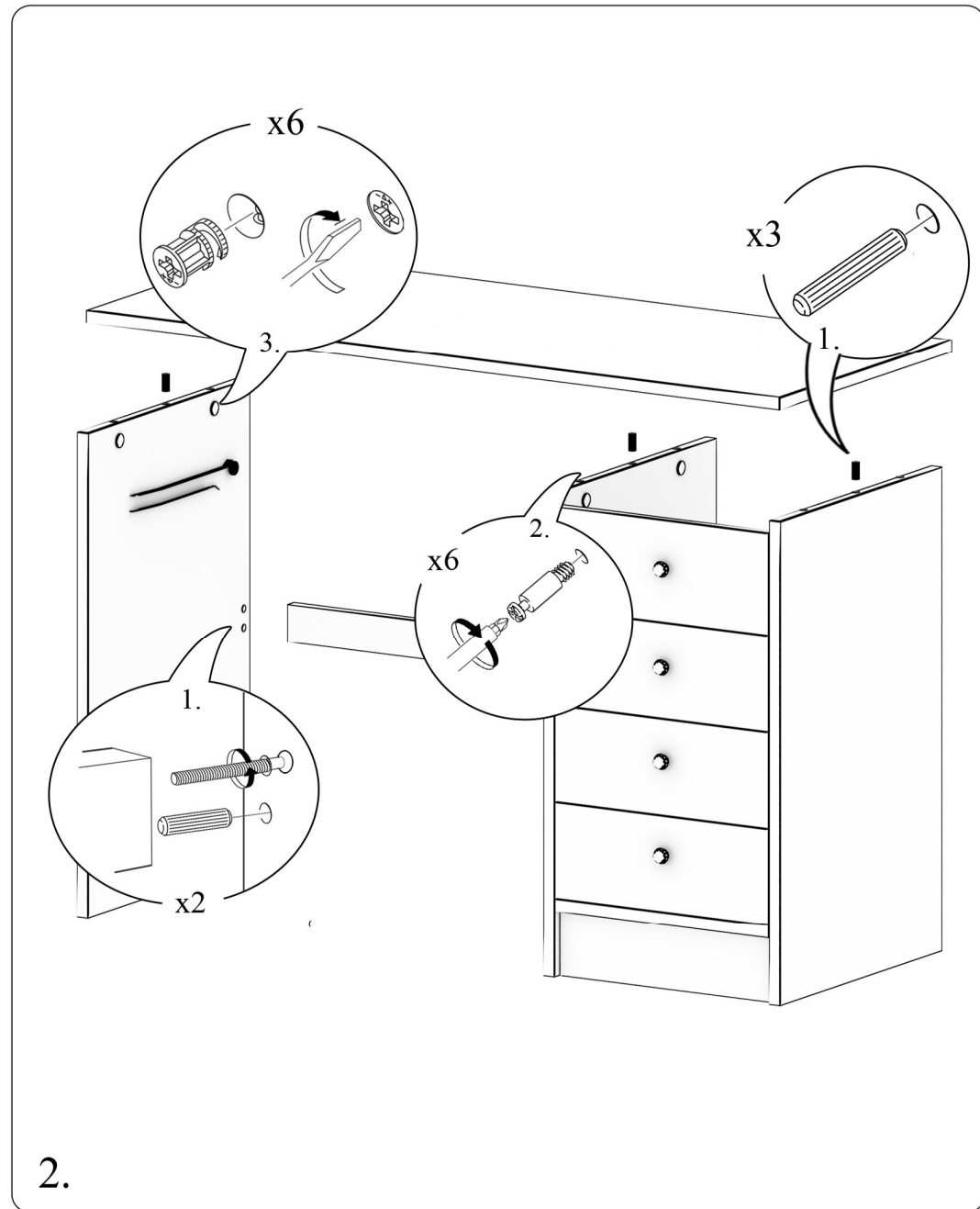
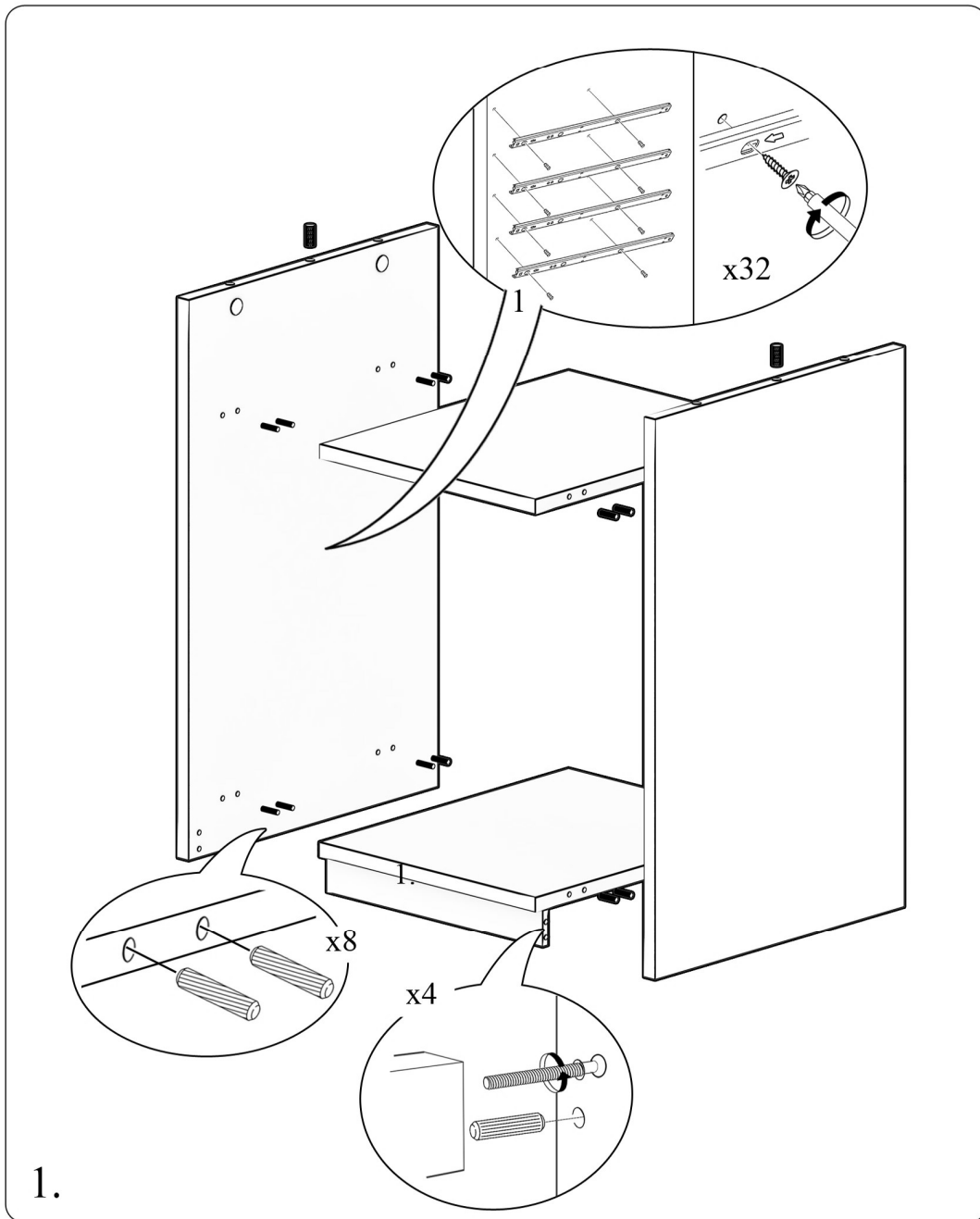