

I  10 cm - x 2

II  3,5 cm - x 24

III  1,6 cm - x 6

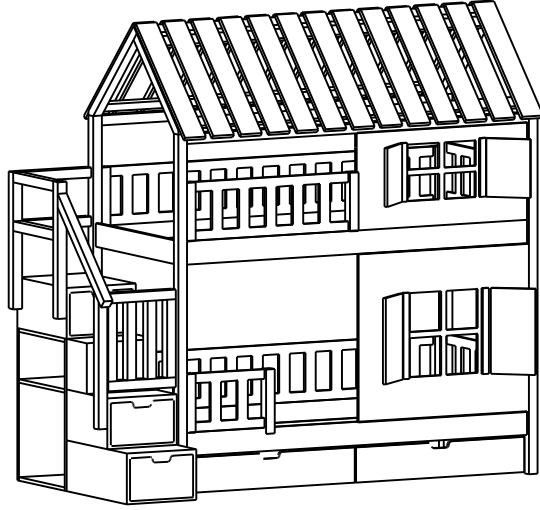

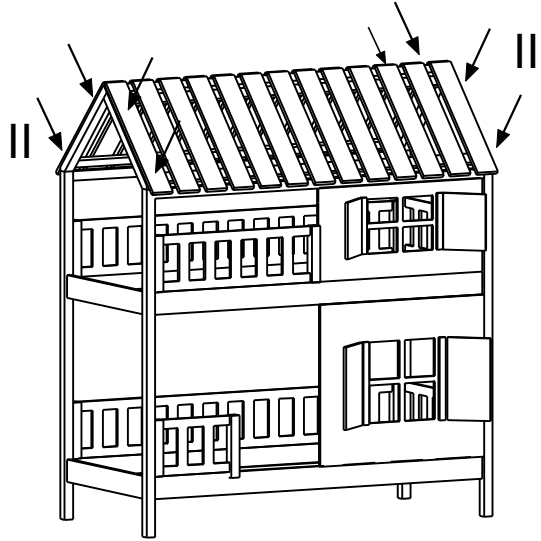
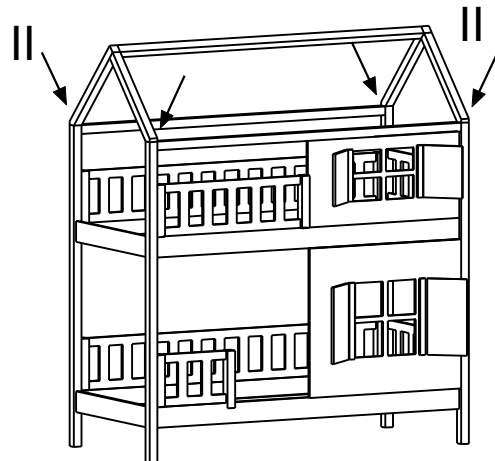
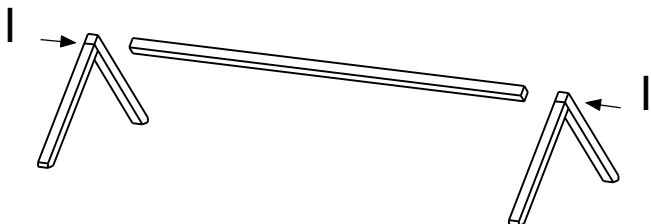
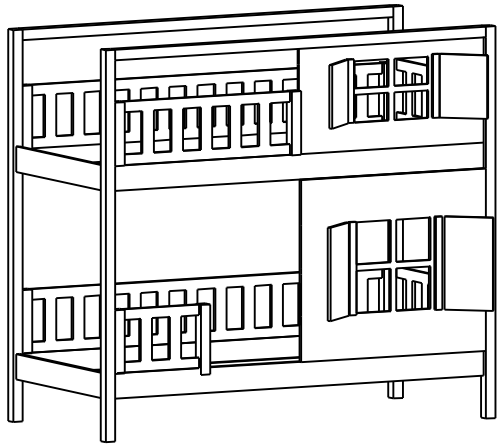
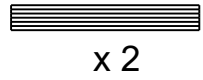
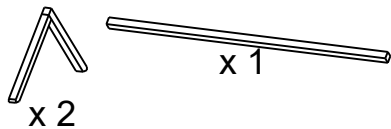
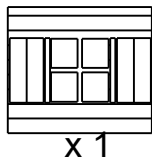
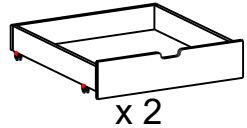
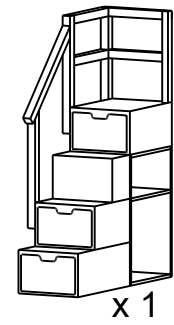
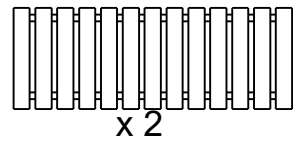
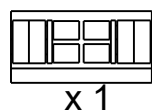
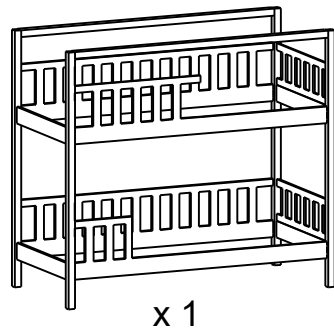
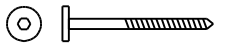

10 cm - x 18

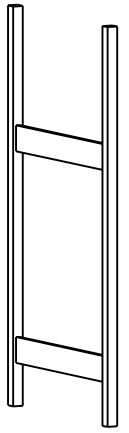

x 1

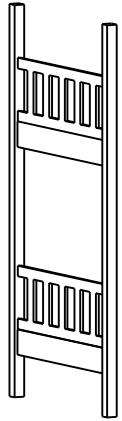

x 1

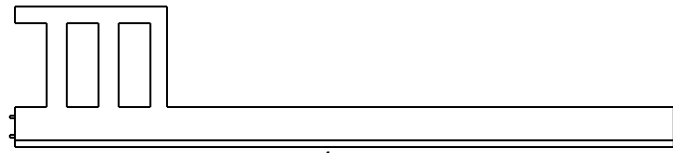

x 1

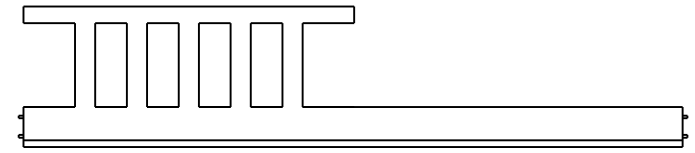

x 1

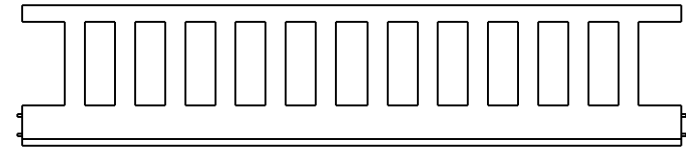

x 2

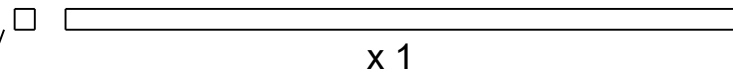

x 1

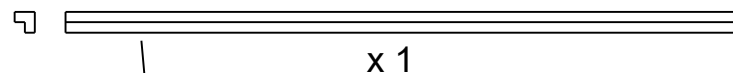

x 1

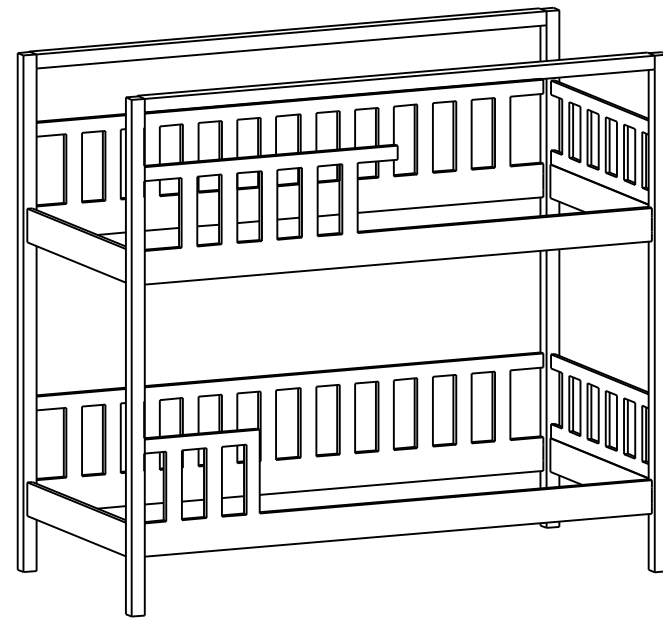
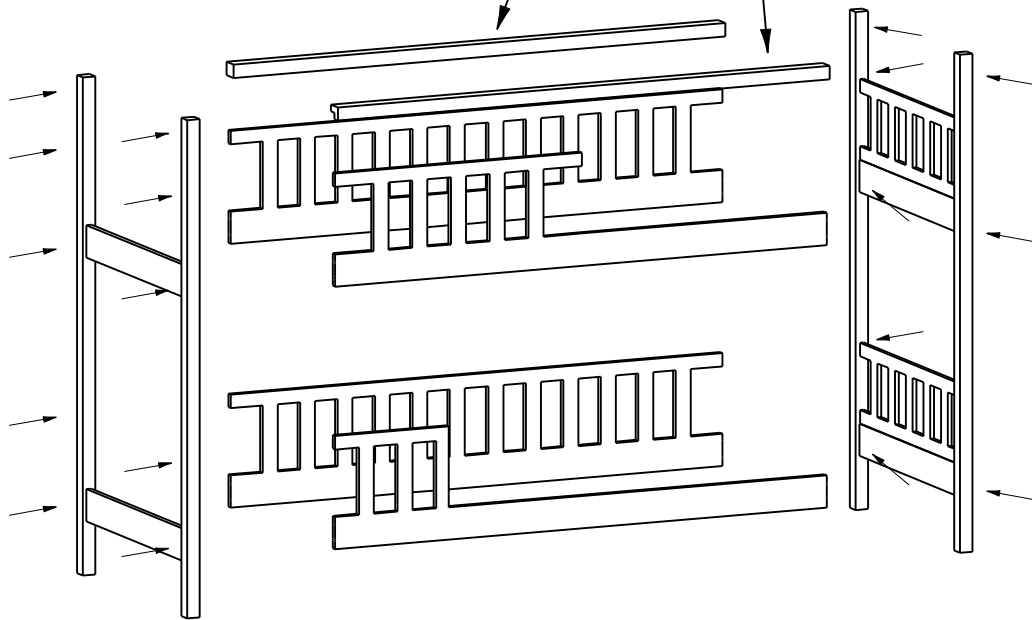

I    Ⓞ    10 cm - x 2

II    Ⓞ    6 cm - x 8

III    ⊕    3,5 cm - x 3

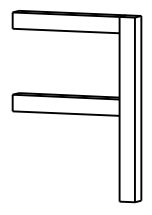
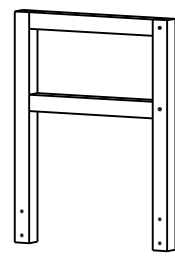
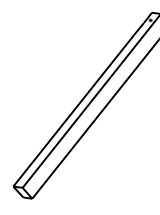

R

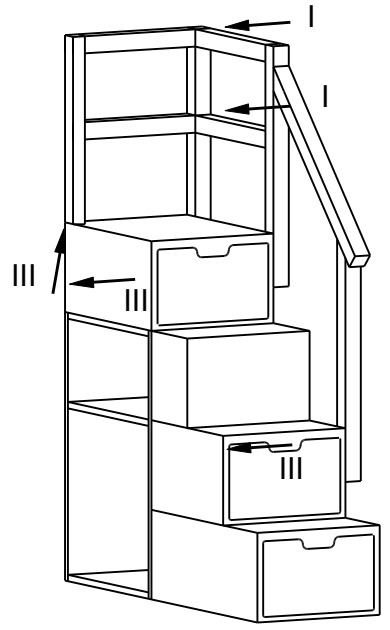
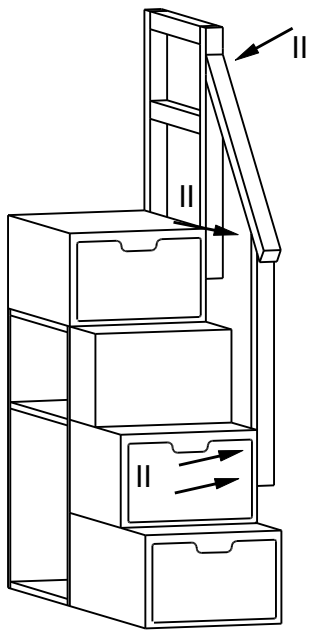
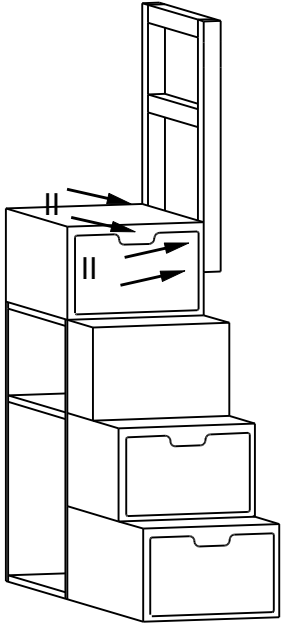

L

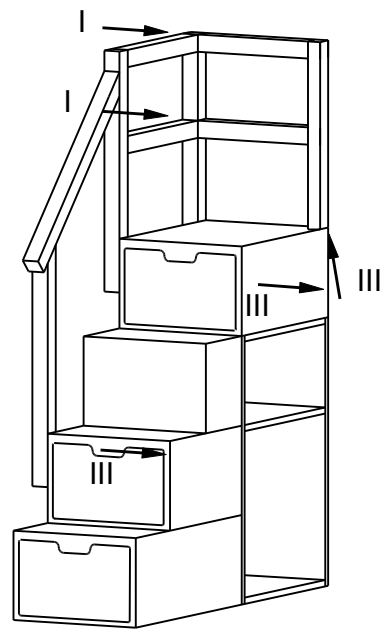
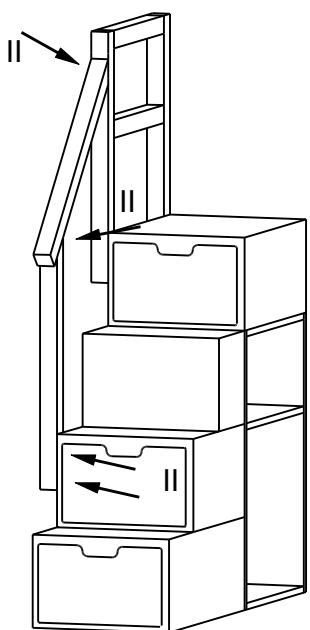
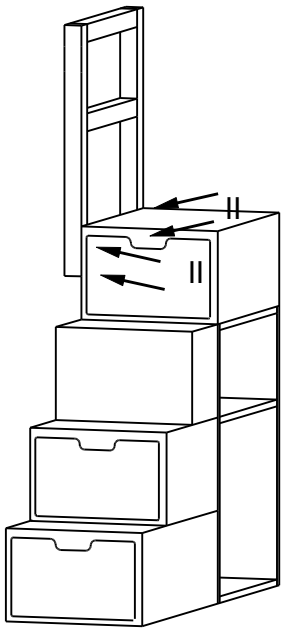

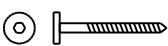
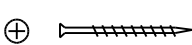
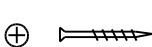
- I  6 cm - x 8
- II  2,5 cm - x 30
- III  1,6 cm - x 16

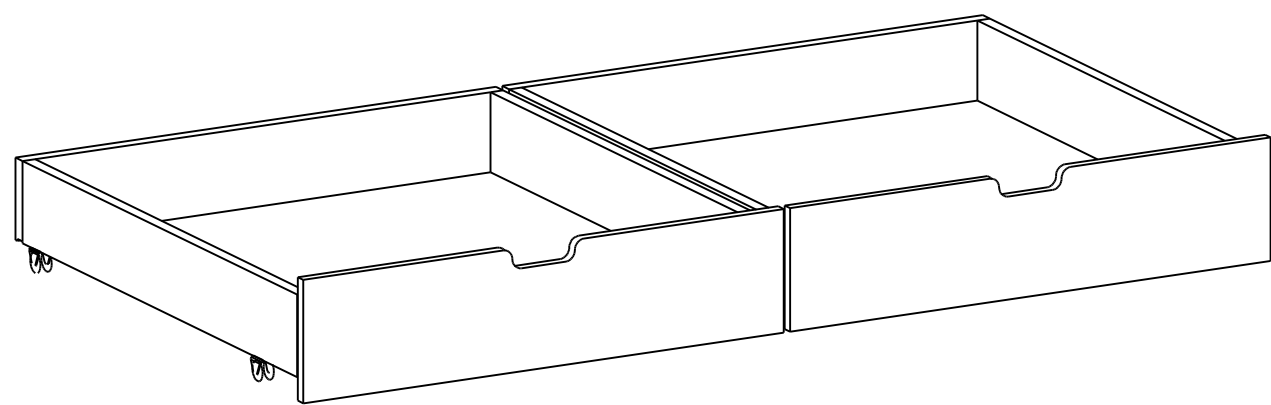
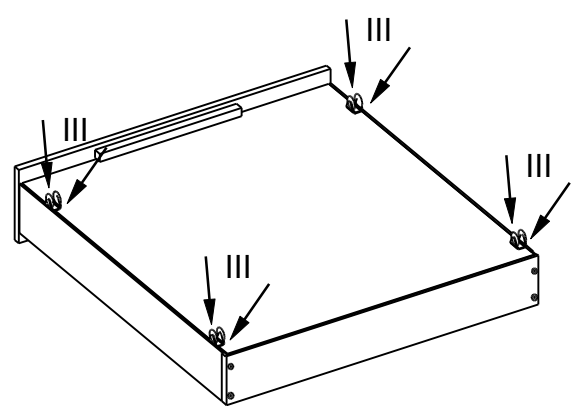
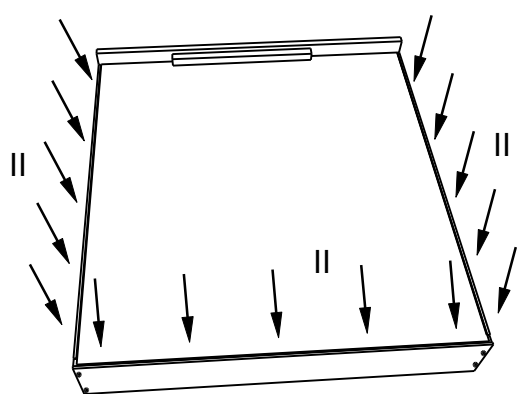
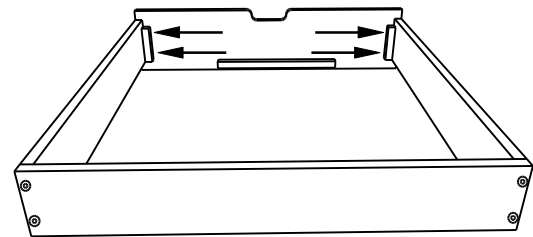
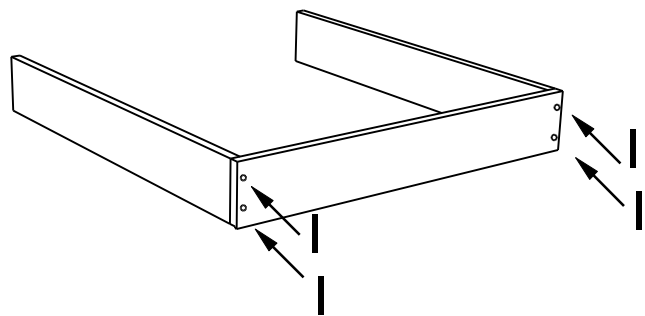
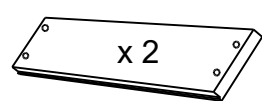
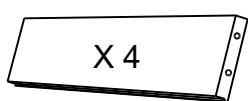
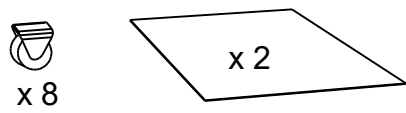
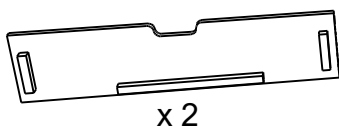

I  10 cm - x 2

II  3,5 cm - x 9

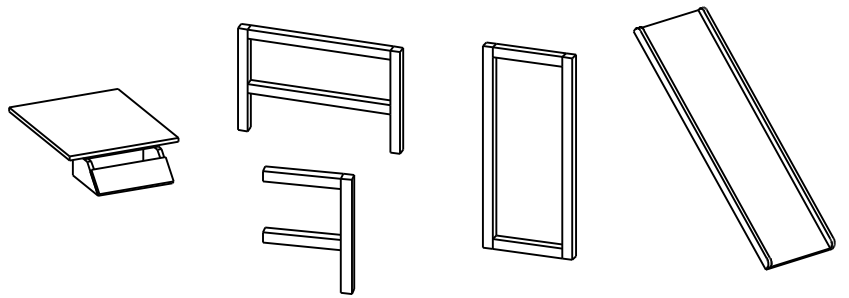

R

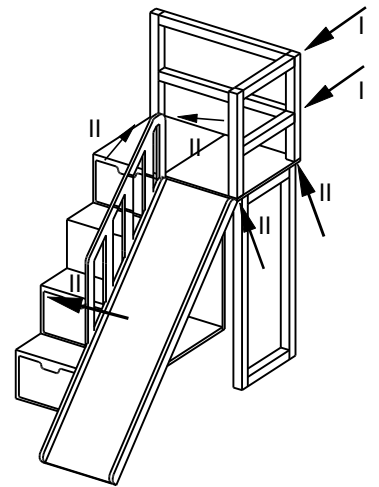
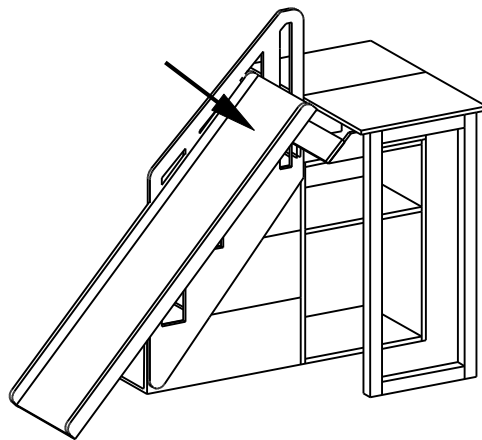
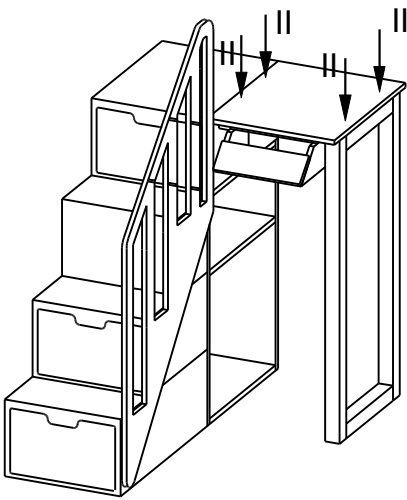

L

