

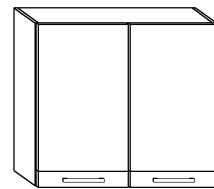

POLO - W80S

→ 80 ↑ 72 ↘ 34



x 12

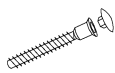

x 4

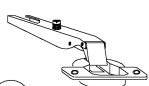

x 4

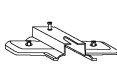

x 2



(a)

(b)

(c)

(d)

x 8



x 2



x 8

(3,5x16)



x 4

(3,5x30)



x 15



x 1



x 1

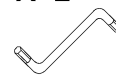

(f)

(g)

(h)

(i)

(j)

(k)

(l)

x 1

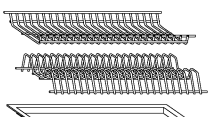

x 1 688mm

(m)

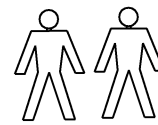
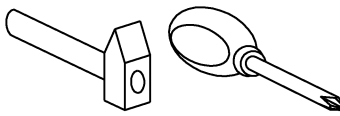
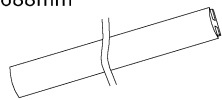

25 min



① - FAZY MONTAŻU

Ⓐ - OZNACZENIE ELEMENTÓW

ⓐ - OZNACZENIE AKCESORIÓW

①

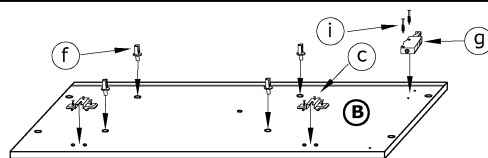
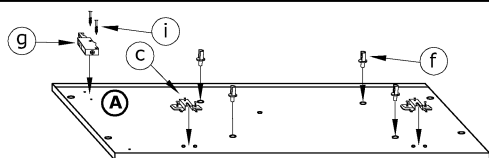

②

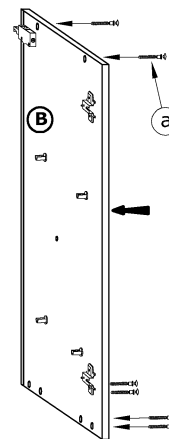
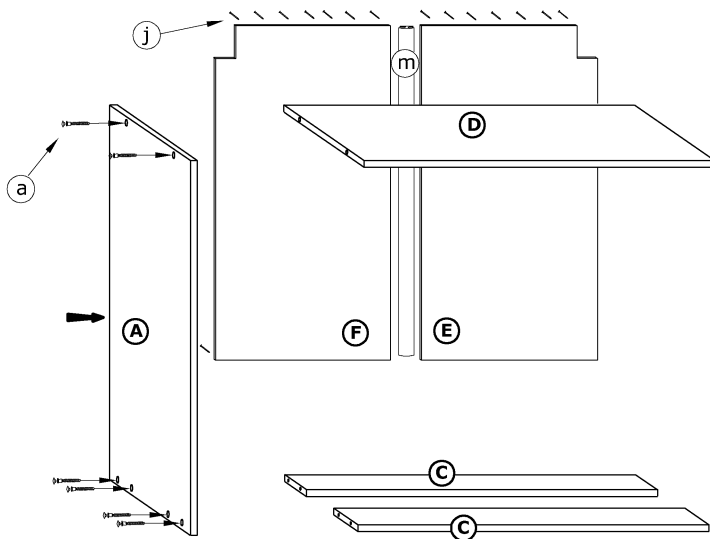

③

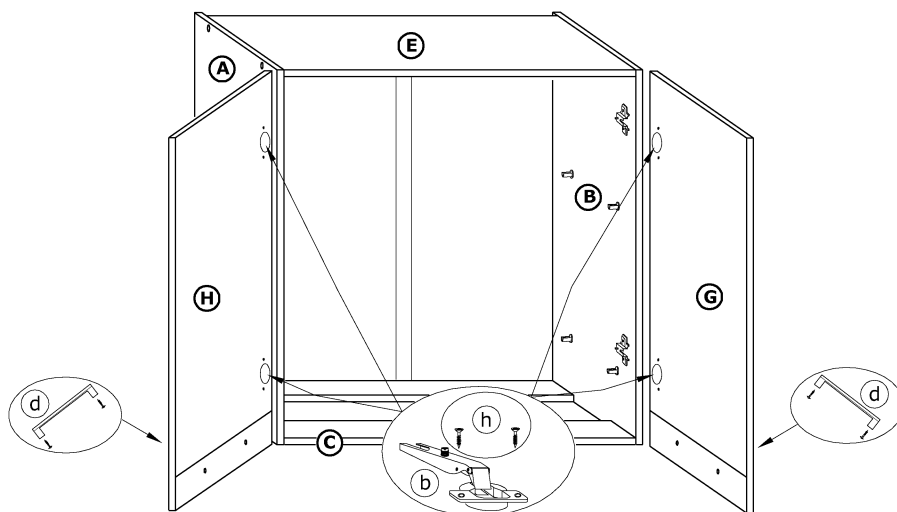

④

