

33 | A



2 kpl | N



1 | I

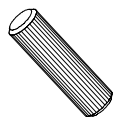

38 | D

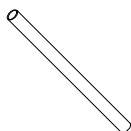

W4x30

2 | G

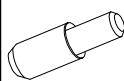

24 | E



1 | L



14 | F

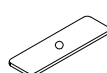



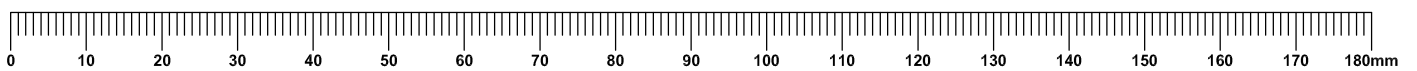

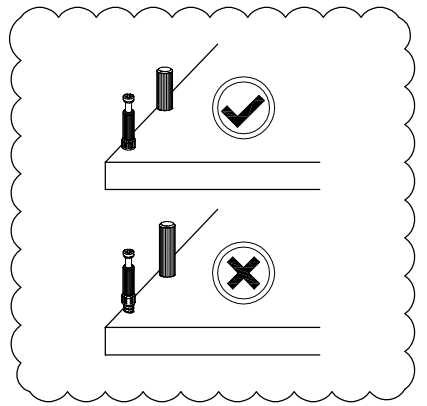
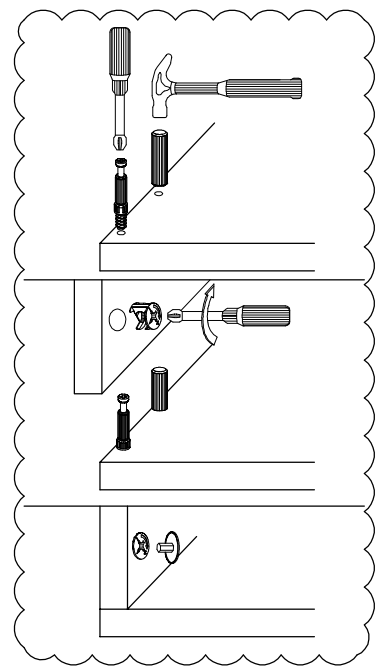
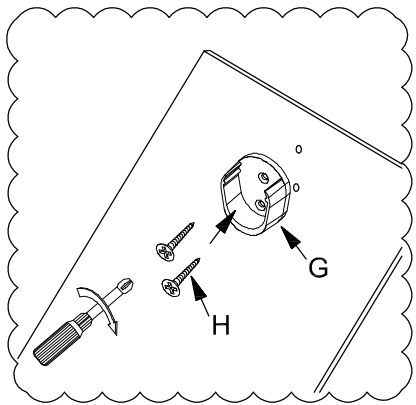
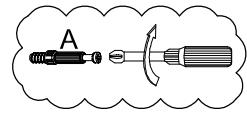
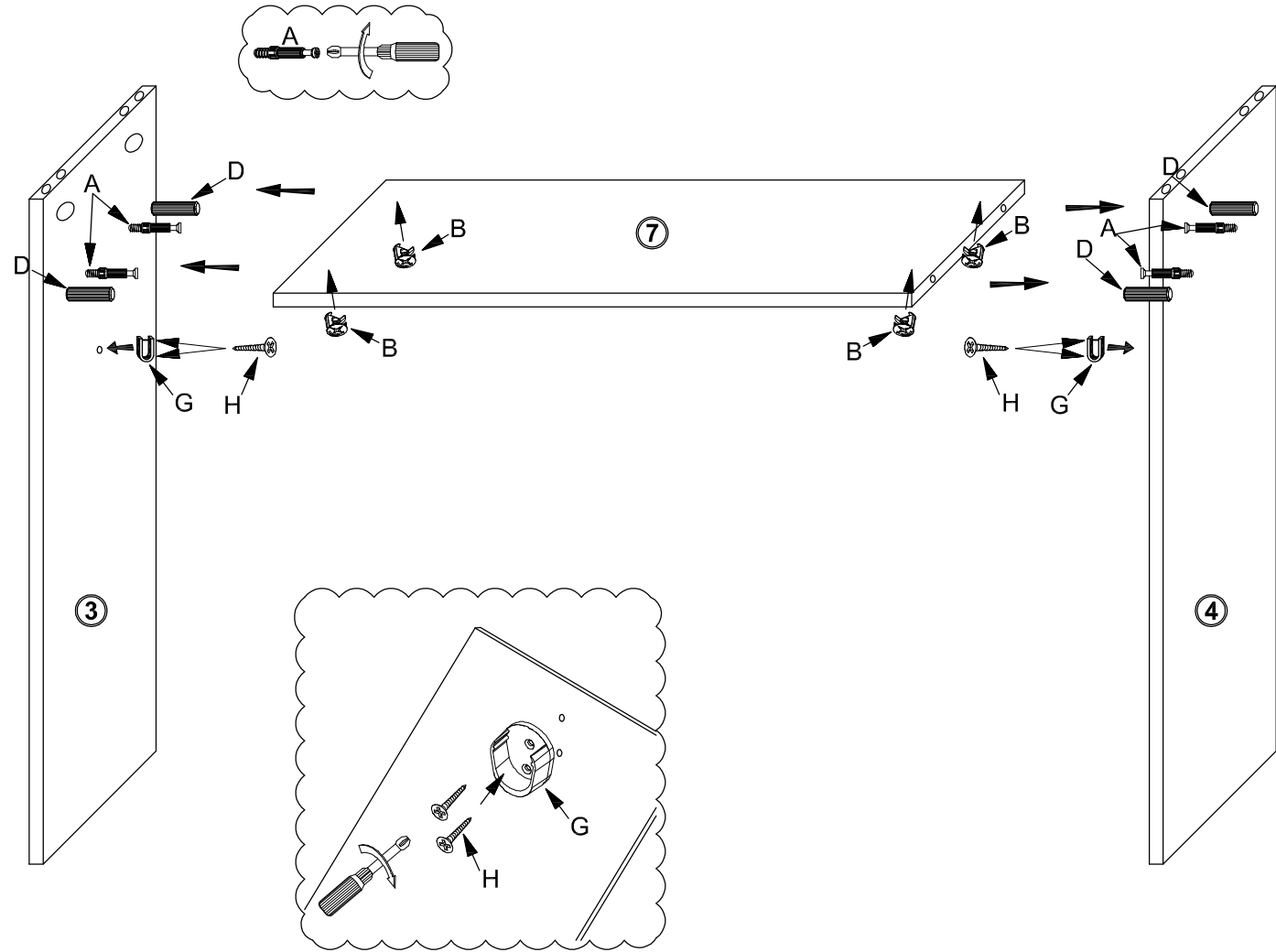

1 | M



1





					
4   A	4   B	4   C	4   D	2   G	4   H



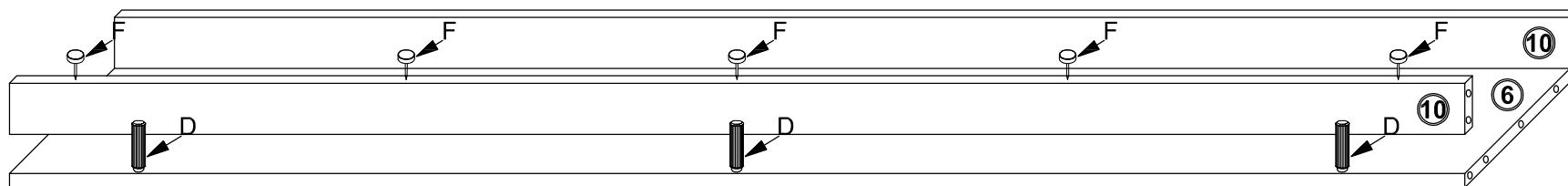
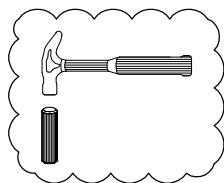
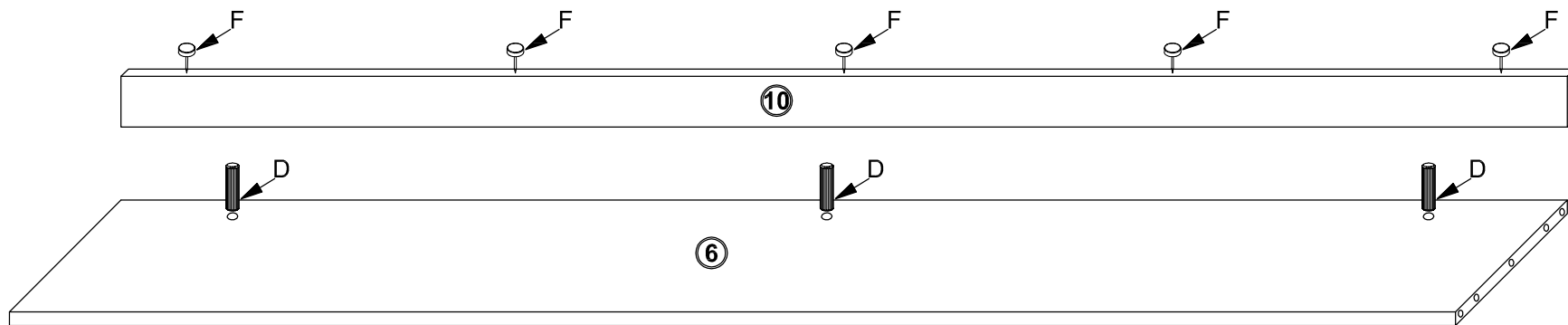

W3,5x13

2



	
6   D	10   F

3

			
12   A	12   B	12   C	8   D

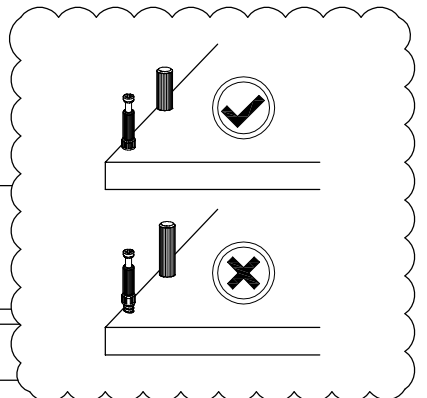
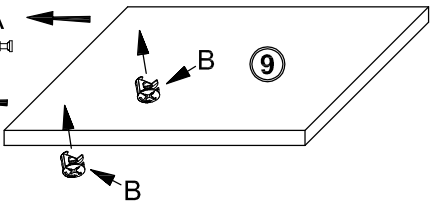
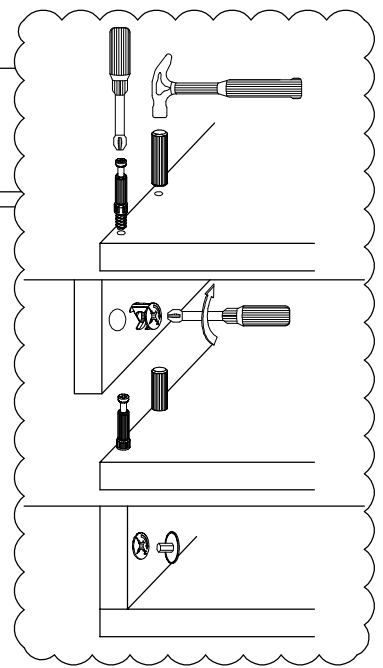
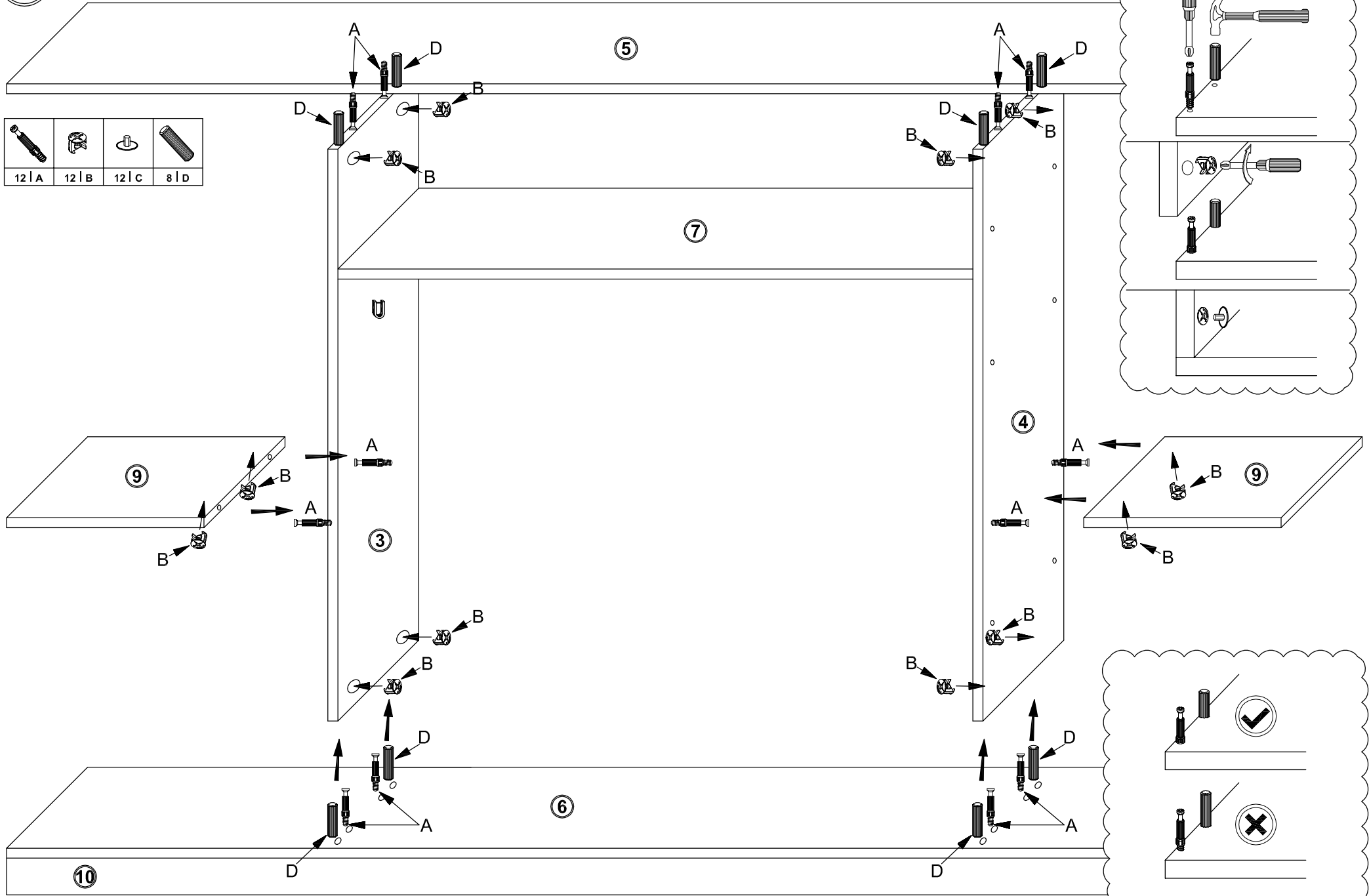

4

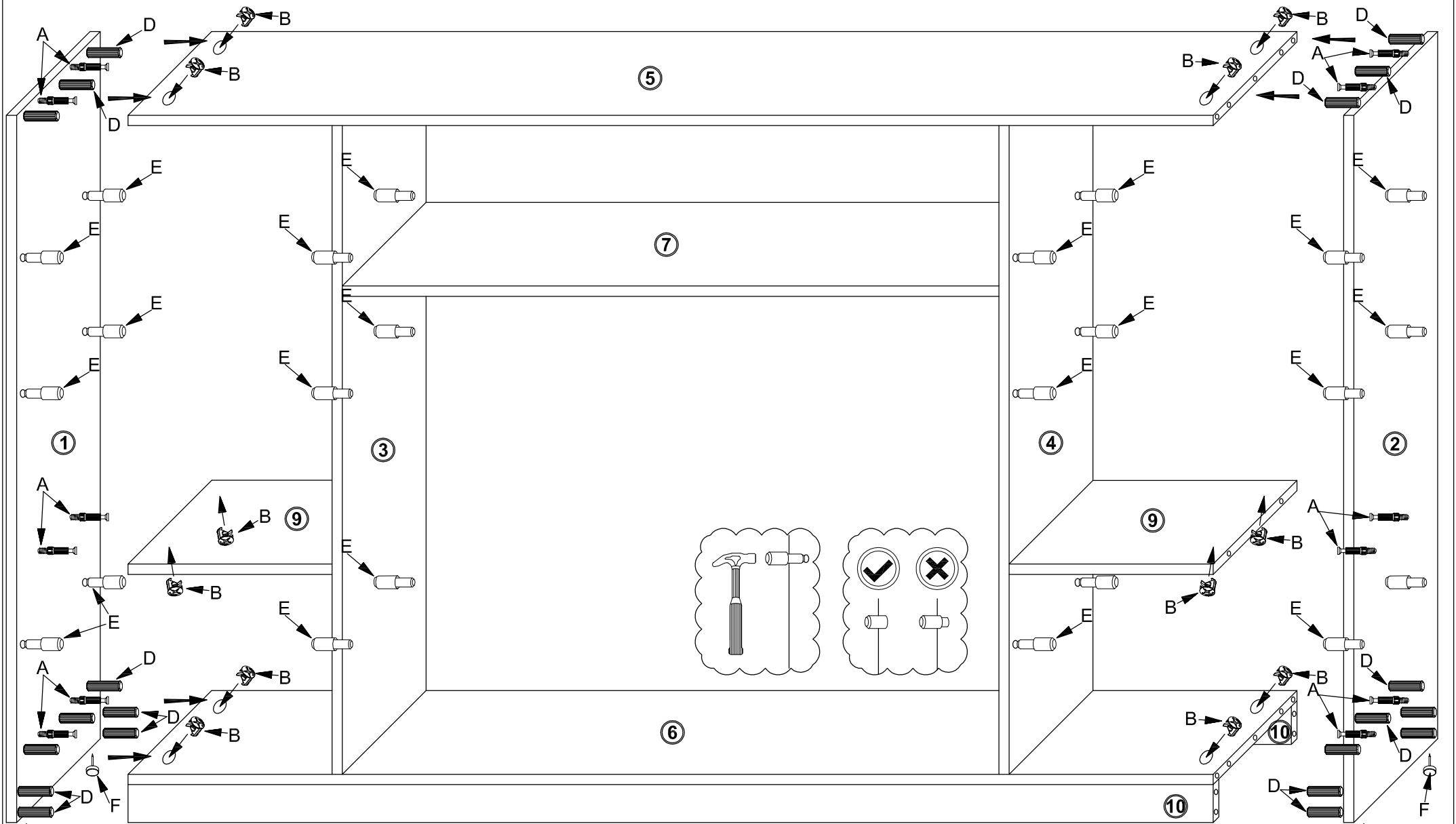

12   A	12   B	12   C	20   D	24   E	4   F

5

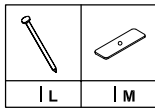
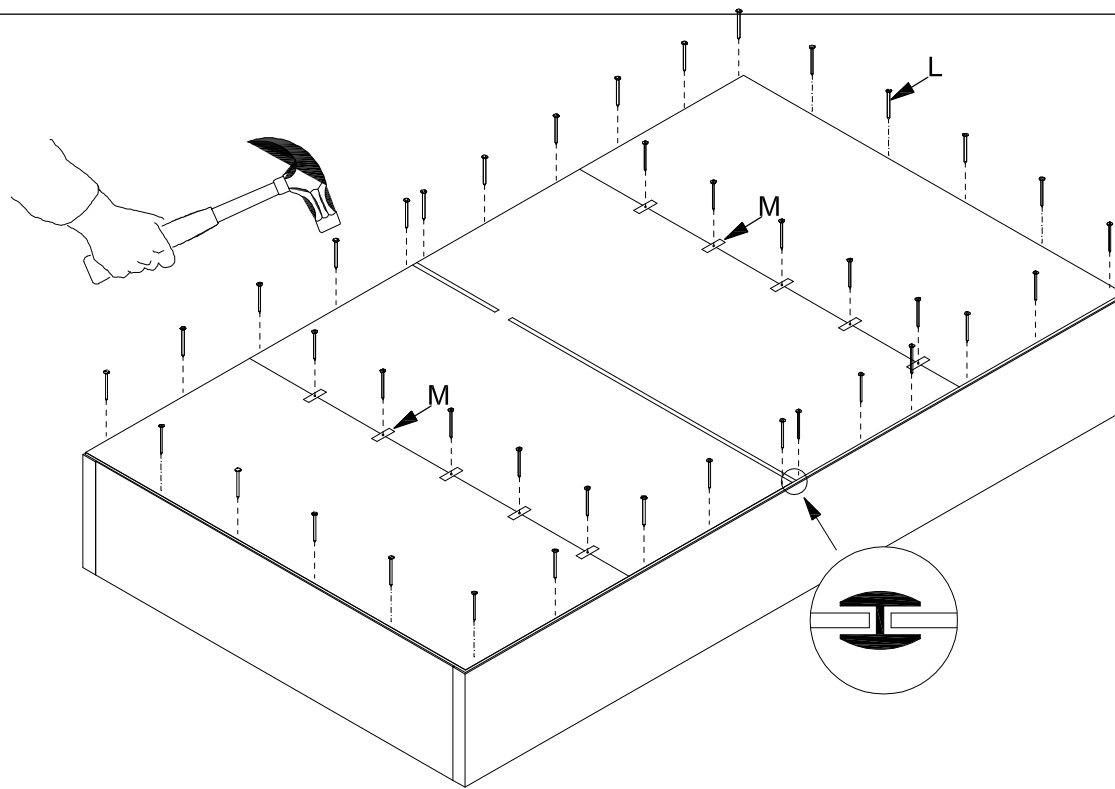

6

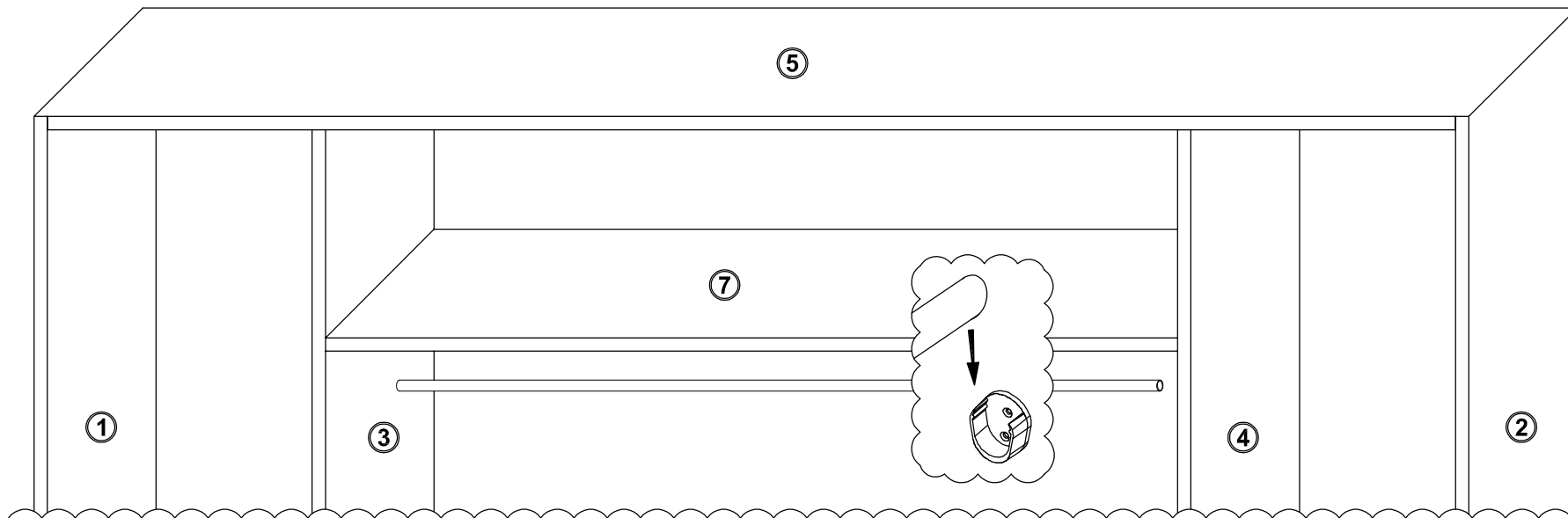

7

1

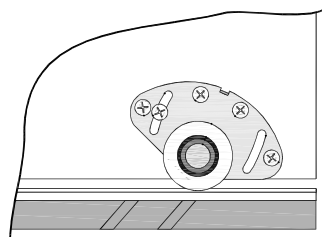
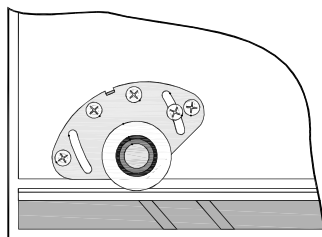
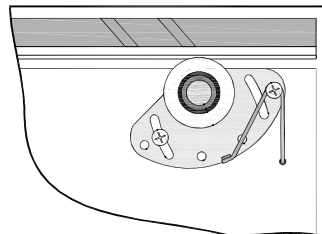
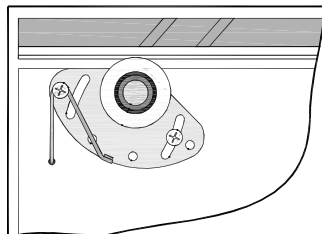
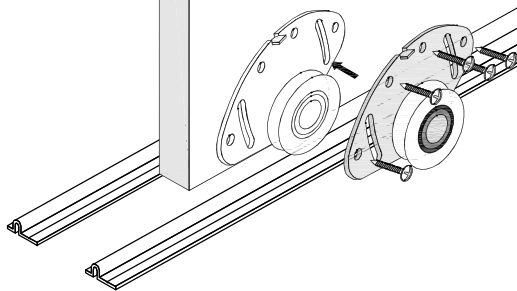
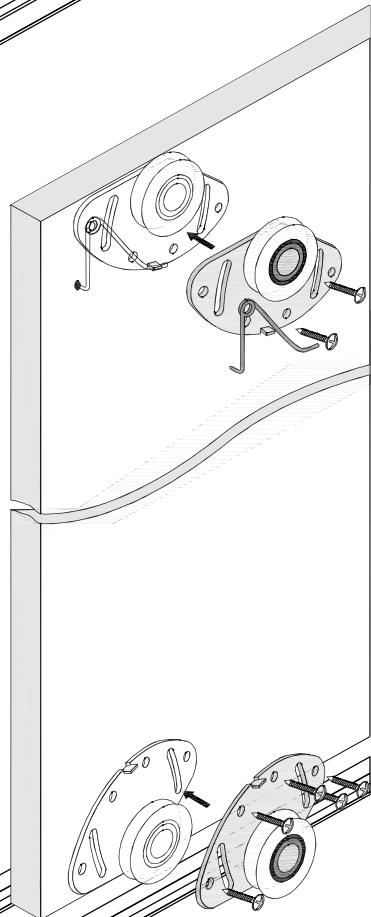
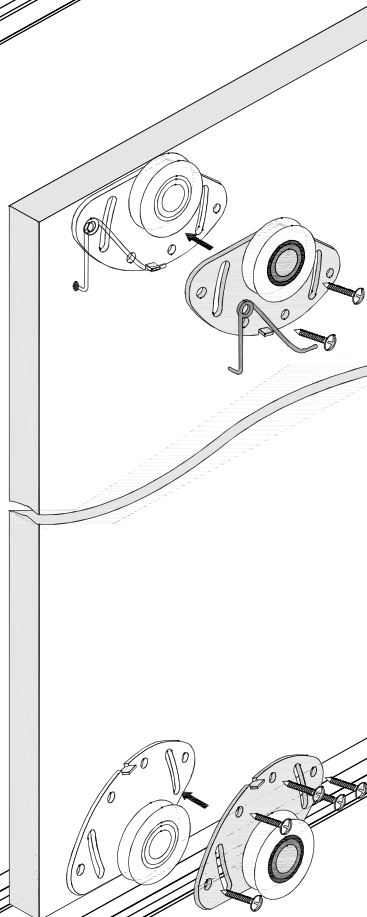
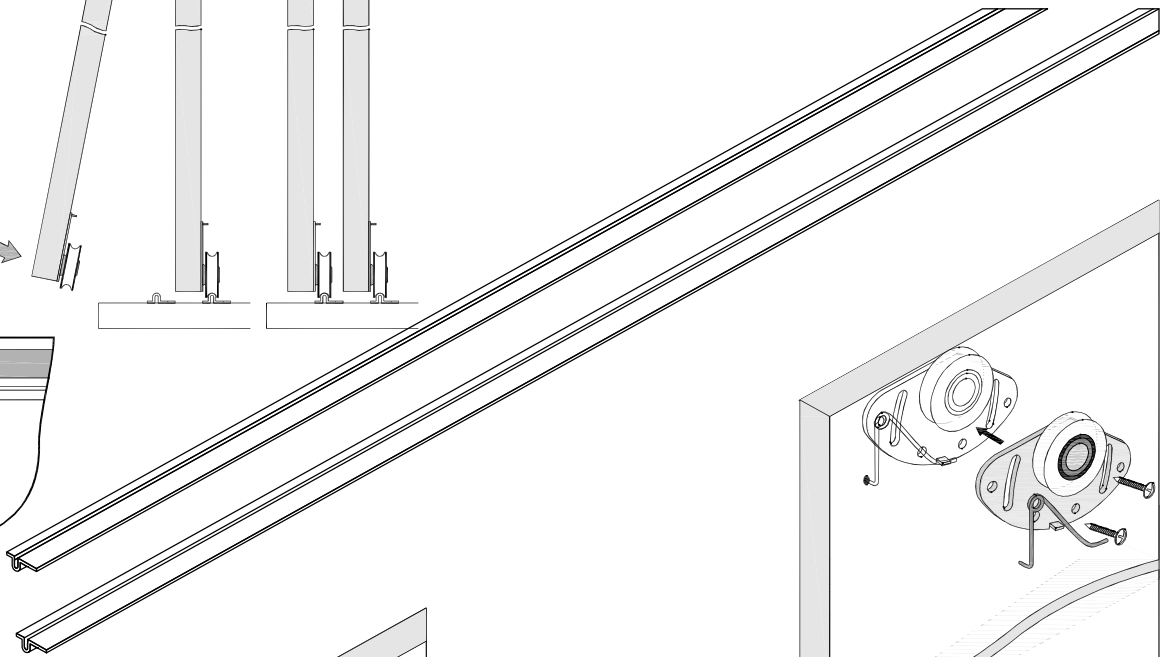
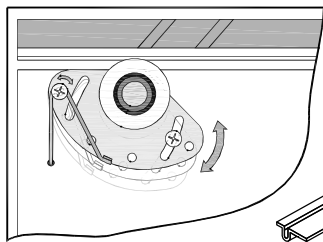
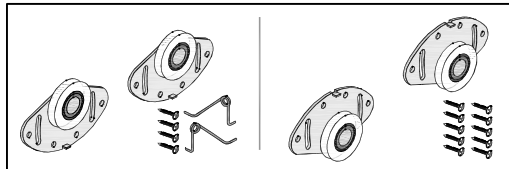

2

3

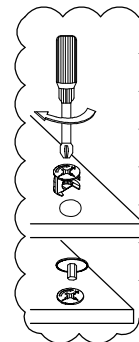
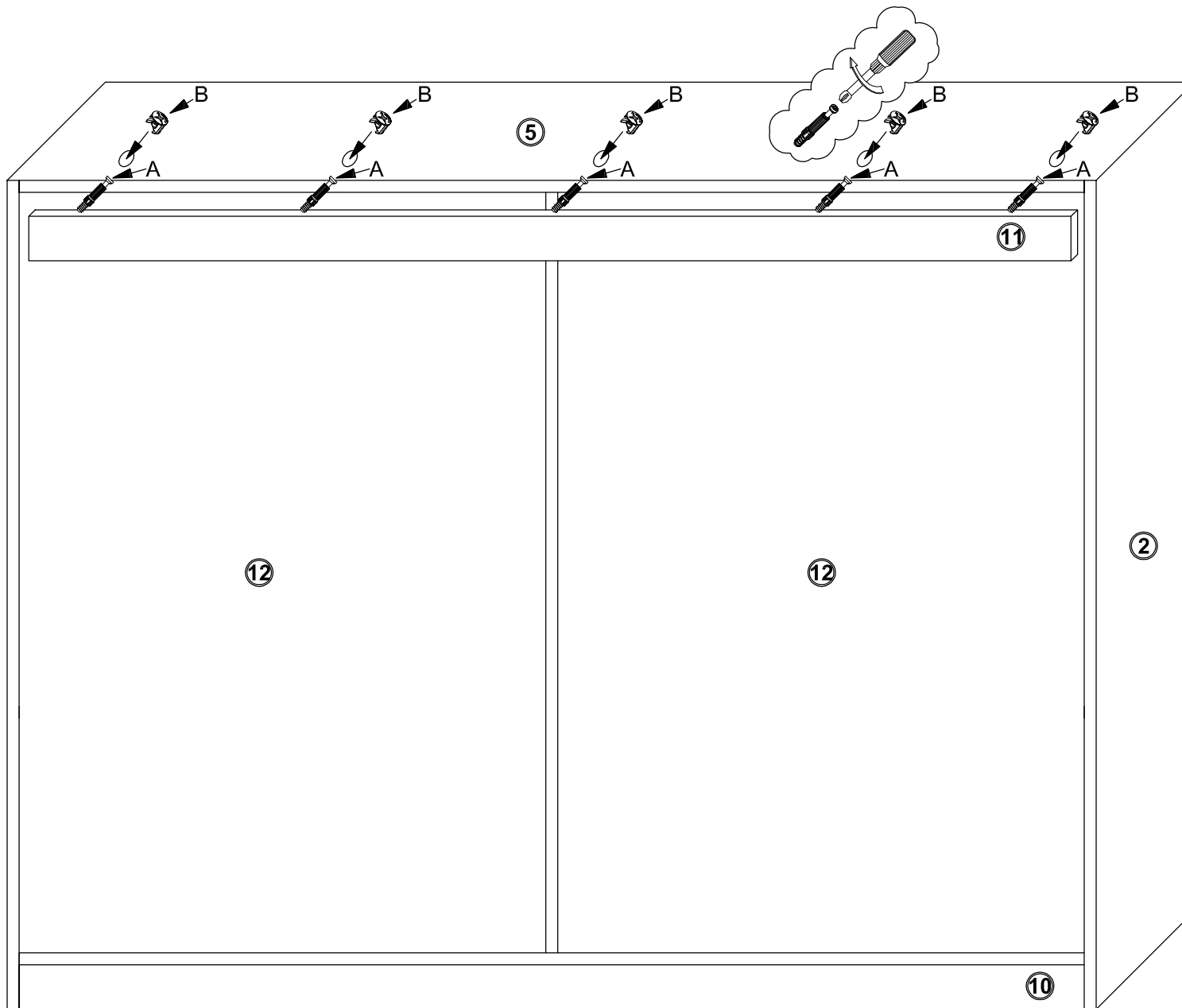

8



		
5   A	5   B	5   C