

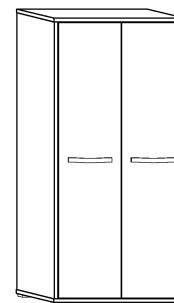

ANG-13

ANGEL- SZAFKA 2D

→ 90 ↑ 198 \ 53



x 8 a	x 4 b	x 4 c	x 2 d	x 3 e	x 3 f		
x 6 g	x 2 k	x 20 (3,5x16) l	x 8 (4x20) m	x 4 (4x25) n	x 60 o	x 1 p	
x 4 h	x 1 (853 mm) i		x 2 j				

① - FAZY MONTAŻU

Ⓐ - OZNACZENIE ELEMENTÓW

Ⓐ - OZNACZENIE AKCESORIÓW

1

x 4 b	x 2 d
x 6 g	x 2 k
x 8 (3,5x16) l	

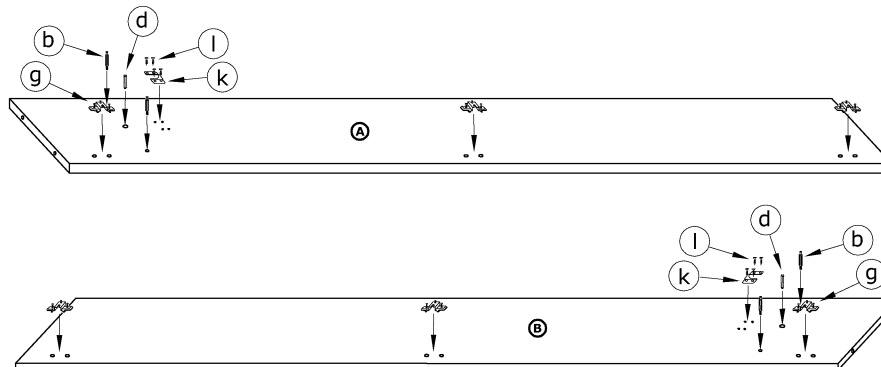

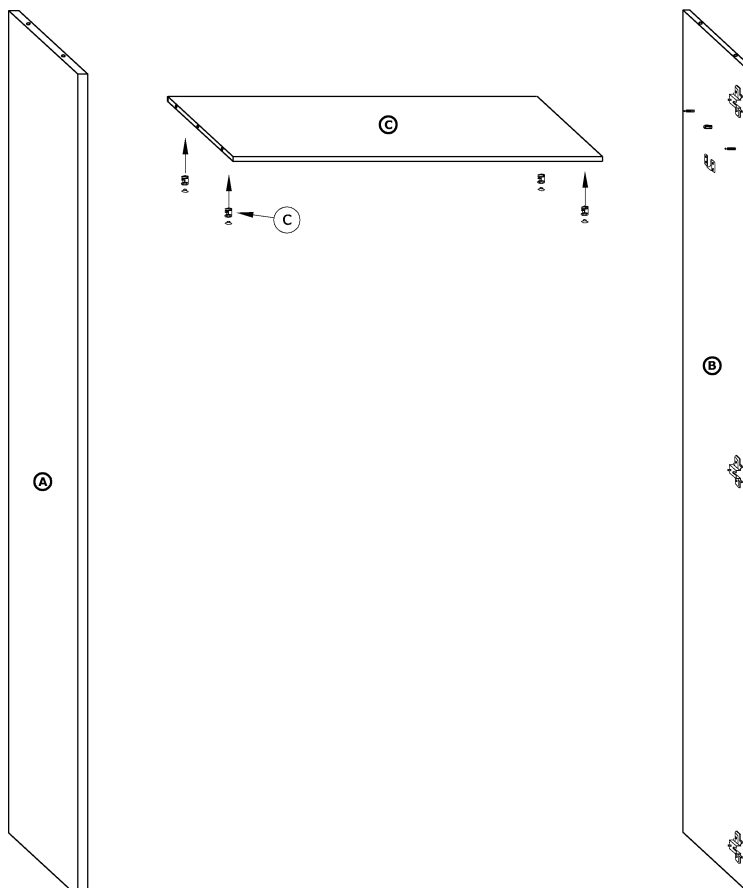

2

x 4 c







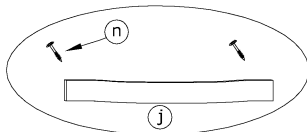
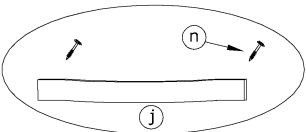
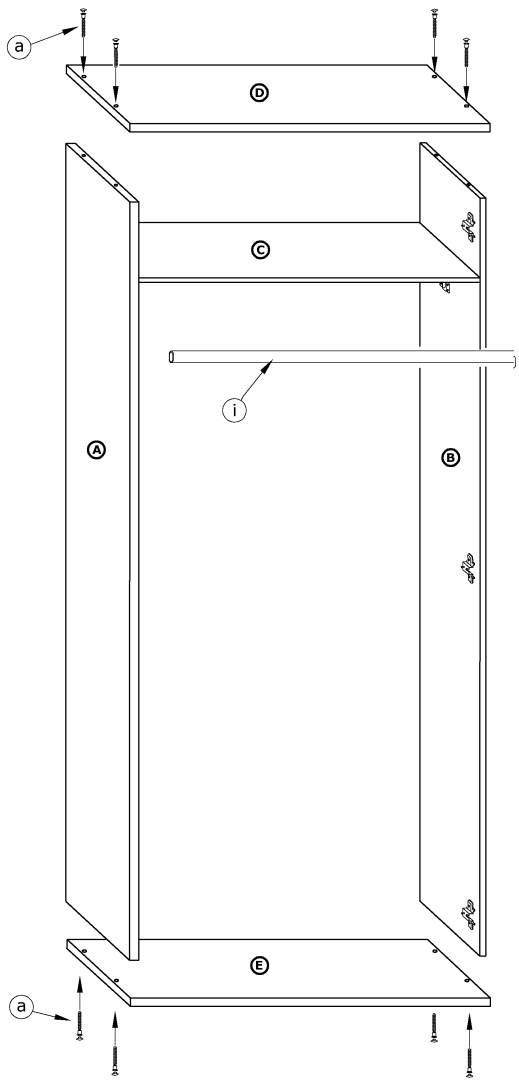



3

- x 8
- 
- a
- x 1
- 
- i



4

- x 3
- 
- e
- x 3
- 
- f
- x 4
- 
- h
- x 2
- 
- j
- x 12
- (3,5x16)
- 
- l
- x 8
- (4x20)
- 
- m
- x 4
- (4x25)
- 
- n
- x 60
- 
- o

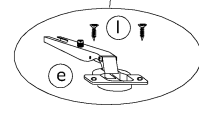
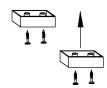
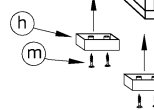
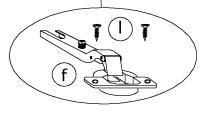
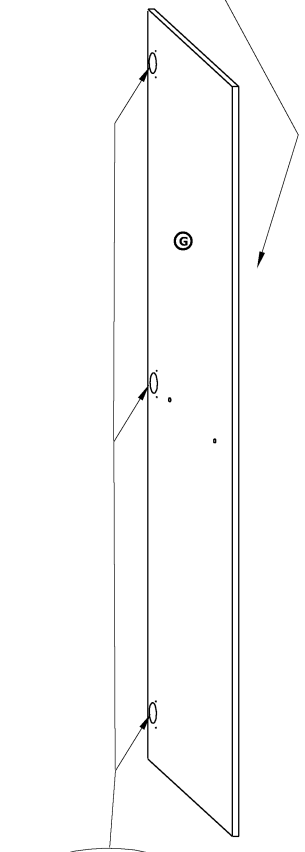
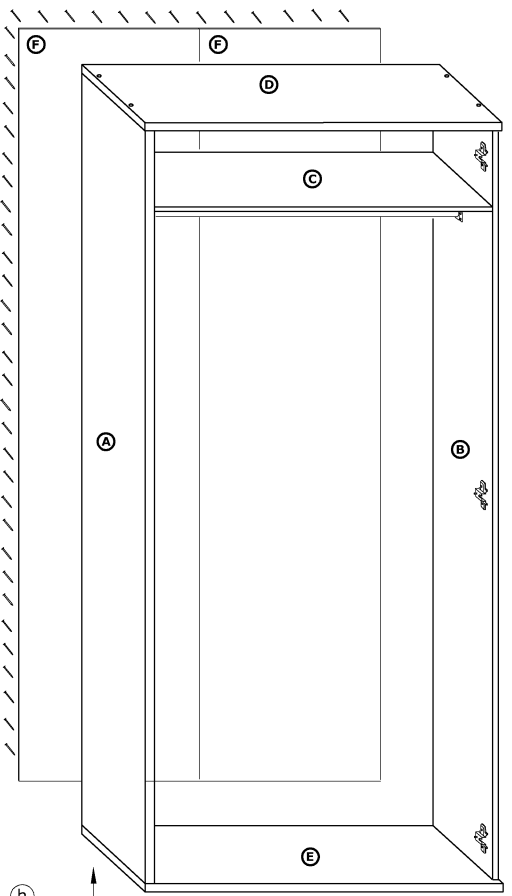
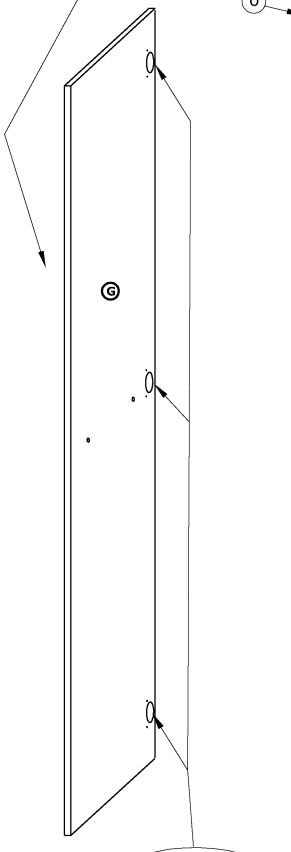



ANG-05

ANGEL- KOMODA 2D3S

- 120 x 77 x 43

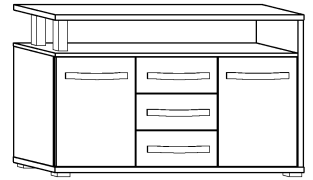

x 12 	x 8 	x 10 	x 8 	x 2 	x 4
x 2 	x 2 	x 6 	x 8 	x 44 (3,5x16) 	x 10 (4x20)
x 10 (4x25) 	x 12 (3,5x30) 	x 2 	x 70 	x 1 	
x 3 kpl. (350 mm) 	x 5 	x 2 186 mm 	x 2 160 mm 	x 5 	

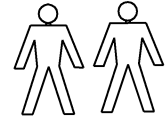

60 min



① - FAZY MONTAŻU

Ⓐ - OZNACZENIE ELEMENTÓW

ⓐ - OZNACZENIE AKCESORIÓW

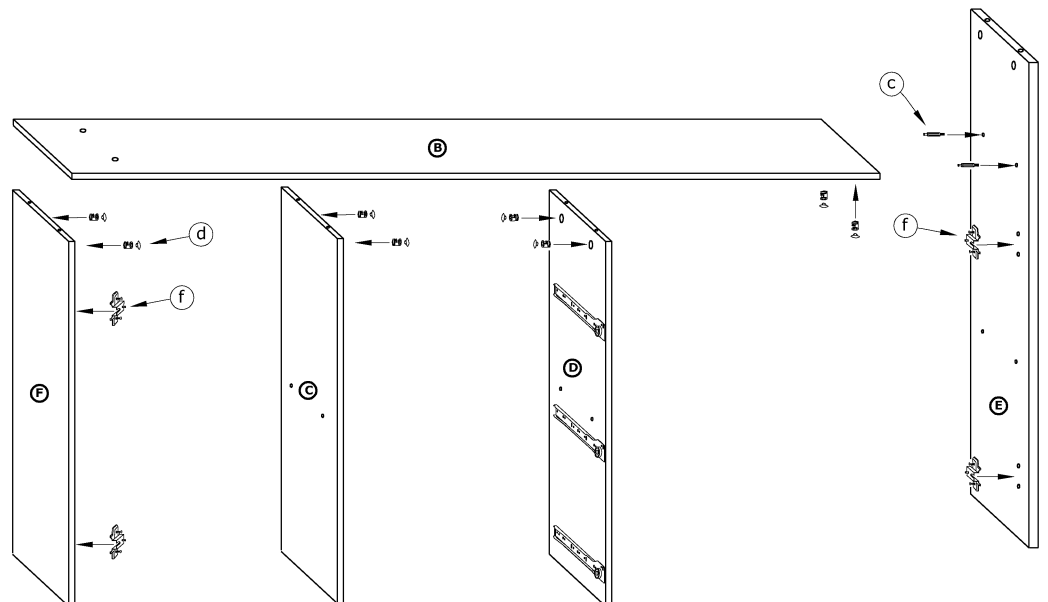
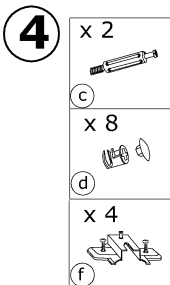
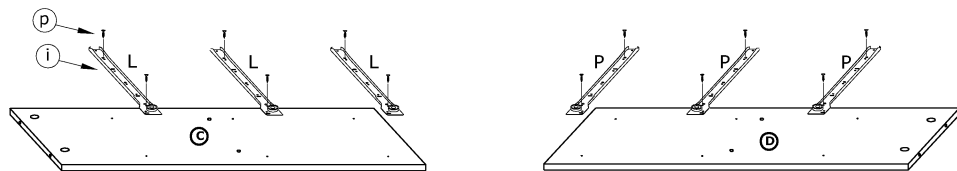
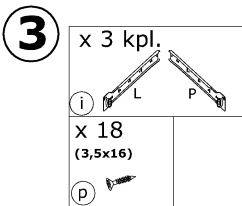
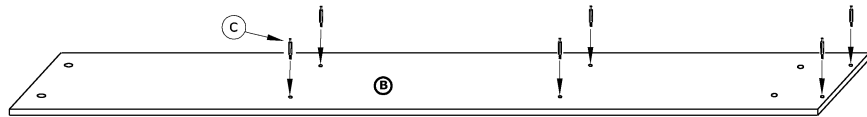
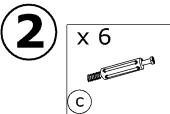
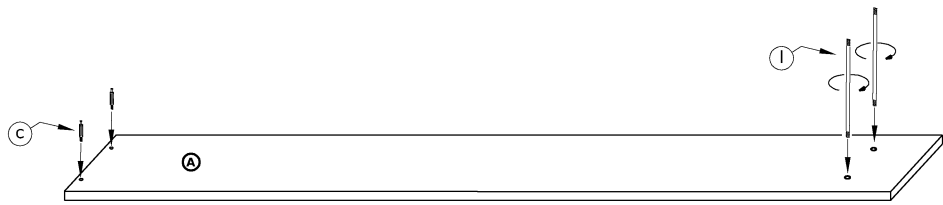
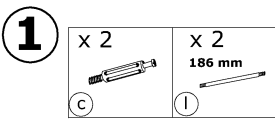

5

- x 8
- (b) x 2
- (e) X 2 160mm
- (n) x 2
- (u)

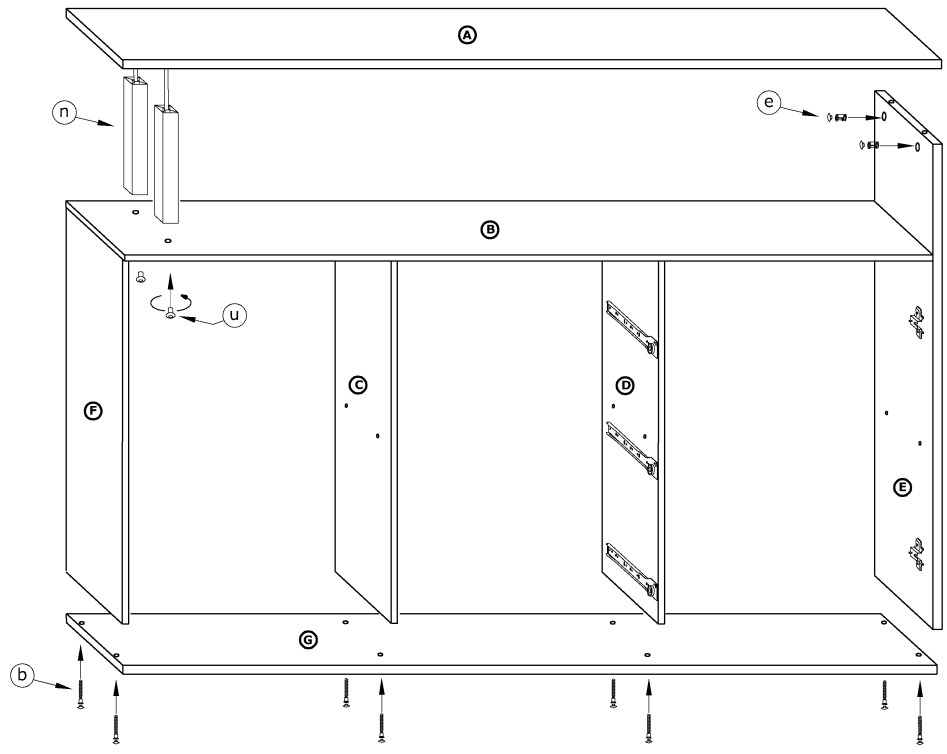

6

- x 5
- (l) x 10 (4x20)
- (r) x 25
- (w) x 8
- (k)

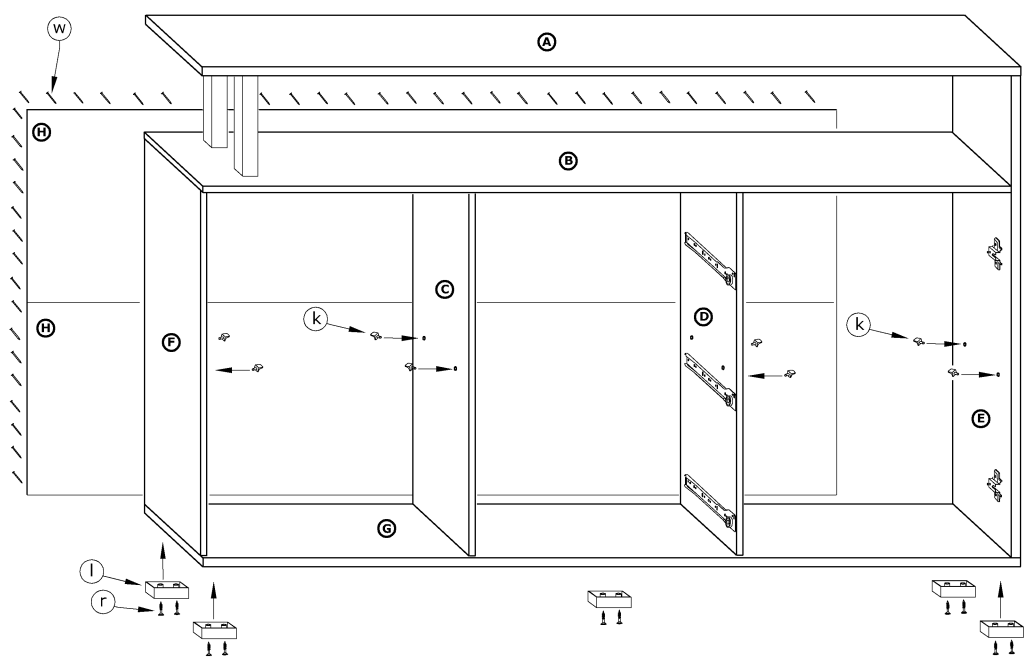

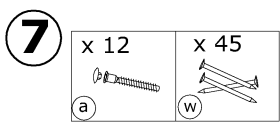

X 3

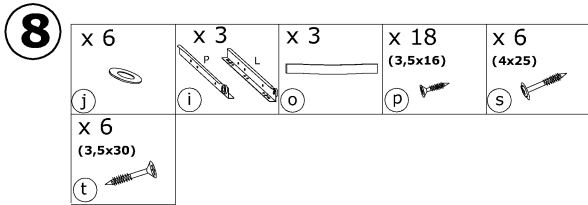
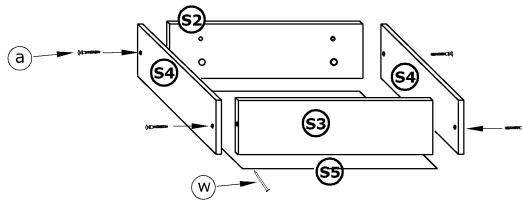

X 3

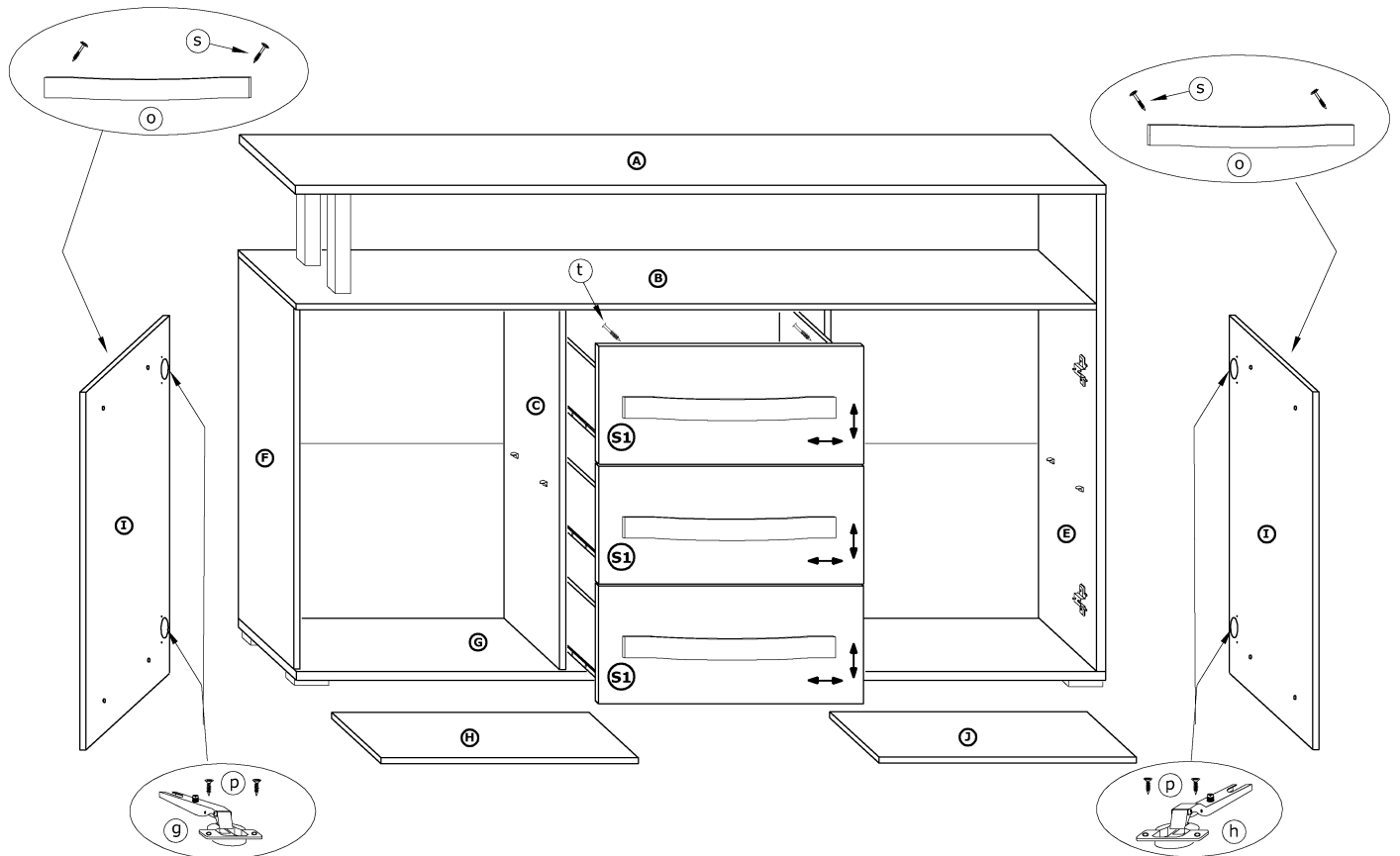
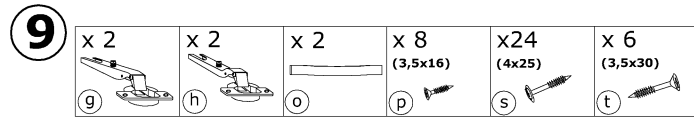
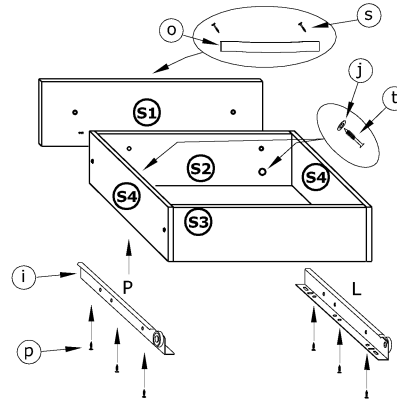



ANG-01

ANGEL- BIELIŻNIARKA 1D3S

→ 90 + 198 \ 43

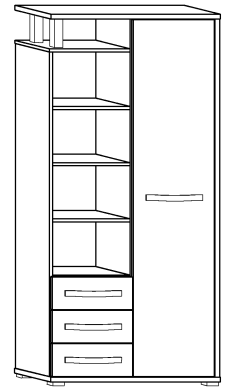





x 16 (a)	x 10 (b)	x 14 (c)	x 14 (d)	x 12 (e)	x 6 (f)
x 3 (g)	x 3 (h)	x 12 (j)	x 42 (3,5x16) (o)	x 8 (4x20) (p)	x 8 (4x25) (r)
x 12 (3,5x30) (s)	x 2 (t)	x 80 (u)		x 1 (w)	 60 min
x 3 kpl. (350 mm) (i)	x 4 (k)	x 2 186 mm (l)	x 2 160 mm (m)	x 4 (n)	

1 - FAZY MONTAŻU

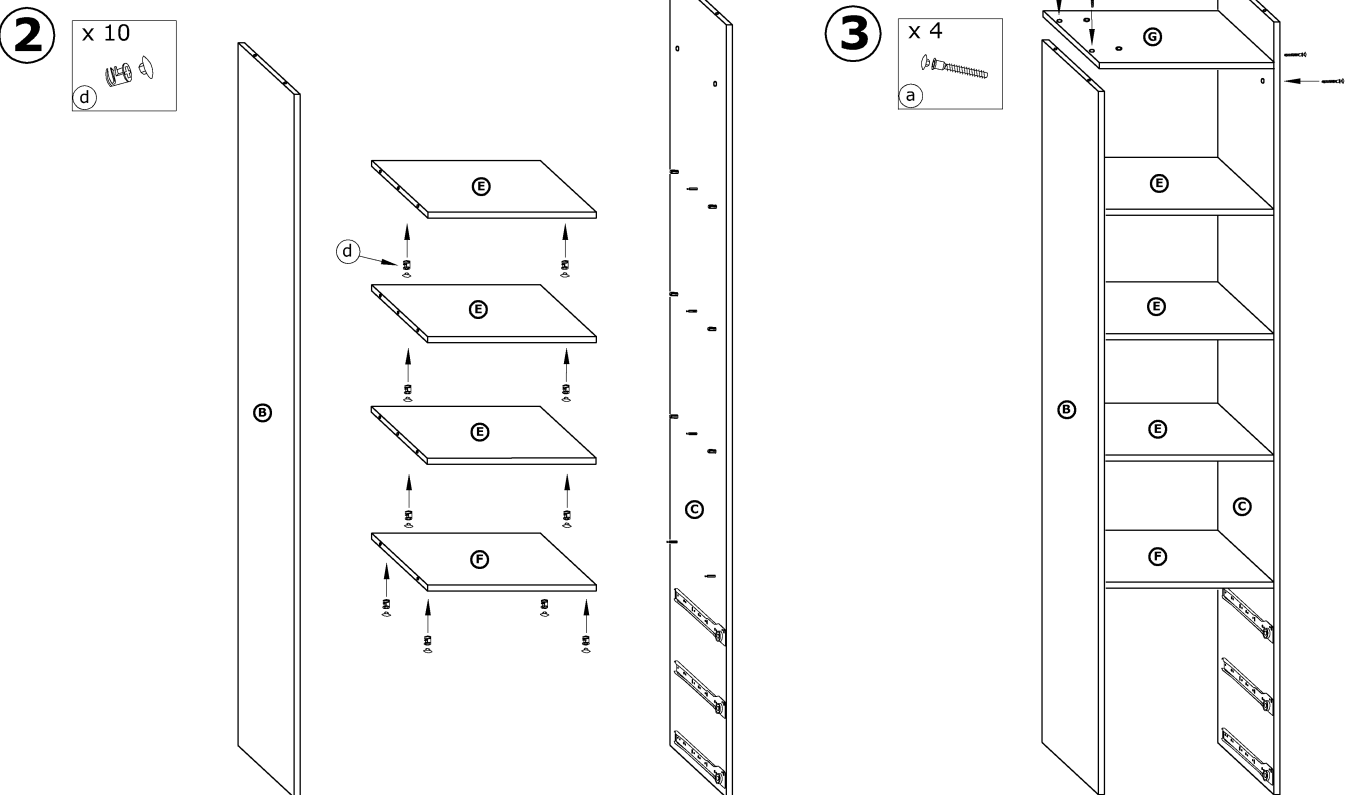
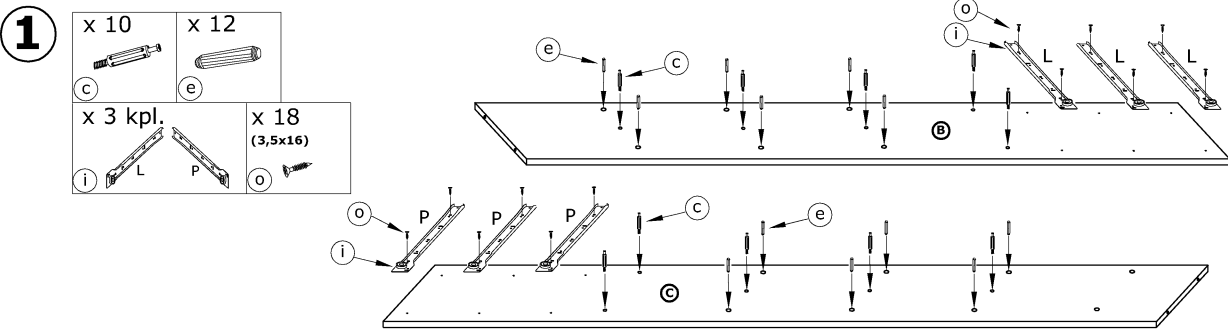

A - OZNACZENIE ELEMENTÓW

a - OZNACZENIE AKCESORIÓW



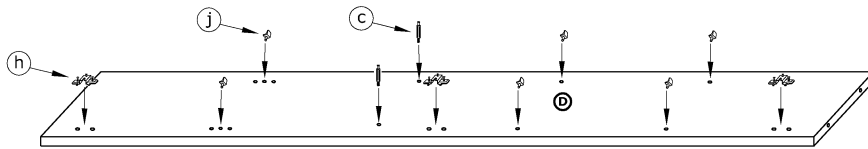

- 4**
- x 2 
 - x 3 
 - x 6 



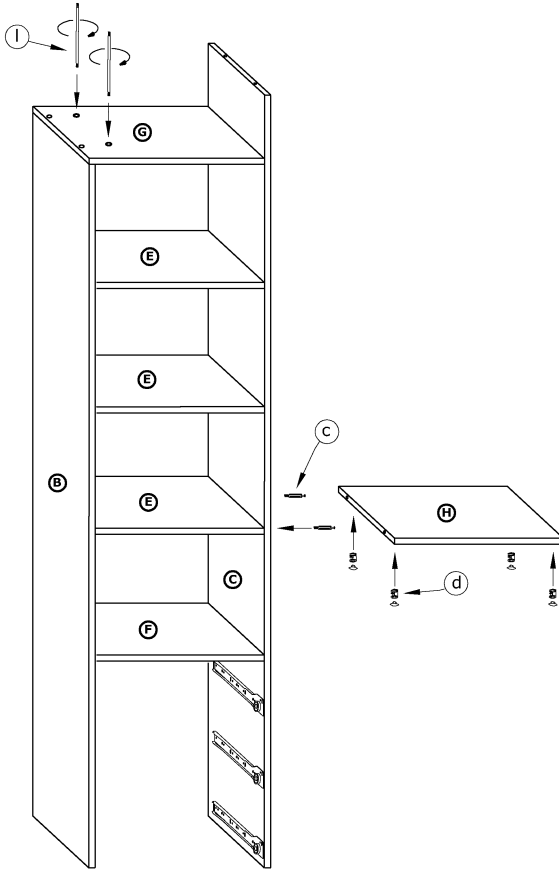

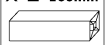
- 5**
- x 2 
 - x 4 
 - x 2
 186 mm 



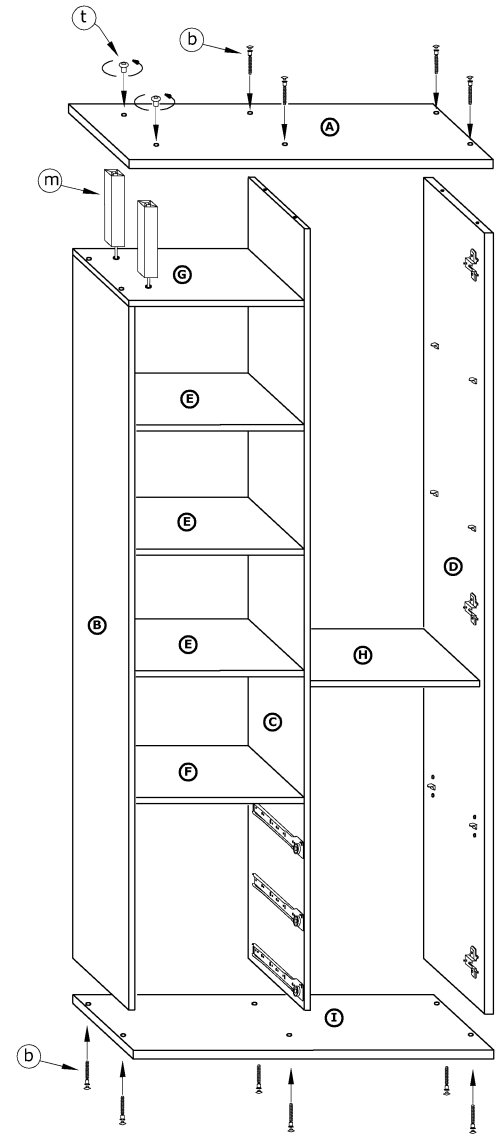

- 6**
- x 10 
 - x 2 160mm 
 - x 2 

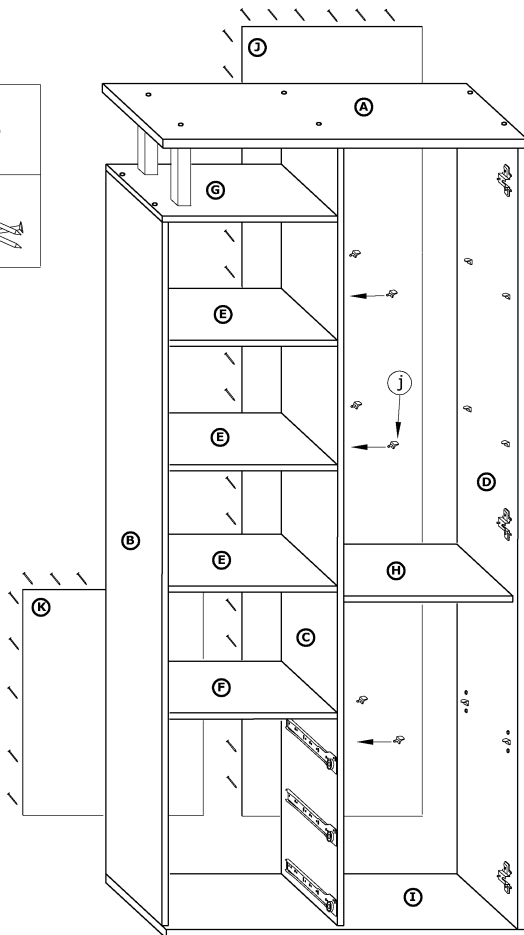

- 7**
- x 6 
 - x 35 



- 8**
- x 4 
 - x 8
 (4x20) 

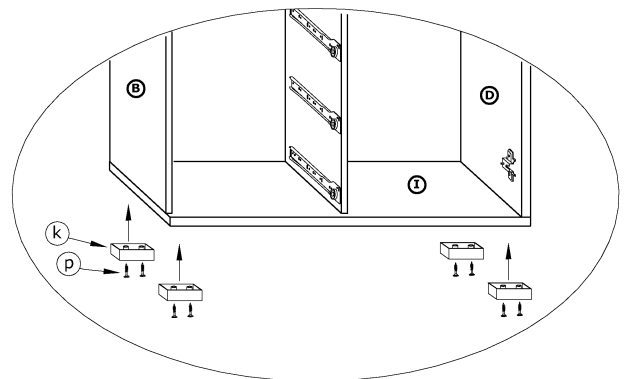

- 9**
- x 12 (a)
 - x 45 (u)

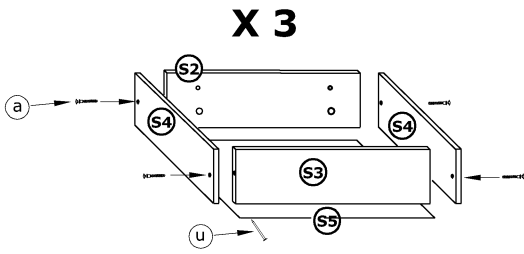

- 10**
- x 6 (f)
 - x 3 (i)
 - x 3 (n)
 - x 18 (3,5x16) (o)
 - x 6 (4x25) (r)
 - x 6 (3,5x30) (s)

X 3

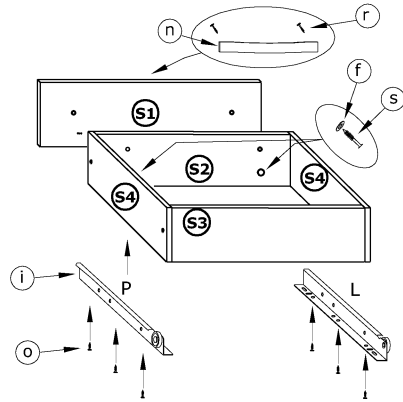

- 11**
- x 2 (g)
 - x 1 (n)
 - x 6 (3,5x16) (o)
 - x 2 (4x25) (r)
 - x 6 (3,5x30) (s)

