

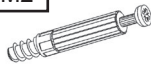













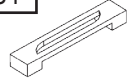

ANIMALS K06

INSTRUKCJA MONTAŻU ASSEMBLY INSTRUCTIONS

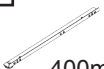
Akcesoria / Fittings

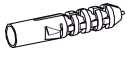
K1  16 szt. / pcs	M2  24 szt. / pcs	M1  24 szt. / pcs	ZM1  28 szt. / pcs		G1  26 szt. / pcs	N1  4 szt. / pcs
W1  Ø3 x 16 48 szt. / pcs	ZW1  16 szt. / pcs	W4  Ø4 x 16 16 szt. / pcs	W6  Ø6,3 x 50 16 szt. / pcs	U1  4 szt. / pcs	U2  8 szt. / pcs	W5  Ø4 x 35 1 szt. / pcs
P1-A  400mm 4 szt. / pcs	P1-B  400mm 4 szt. / pcs	P2-A  400mm 4 szt. / pcs	P2-B  400mm 4 szt. / pcs	Q1  1 szt. / pcs	Q2  1 szt. / pcs	TZ1  1 szt. / pcs

Narzędzia / Tools

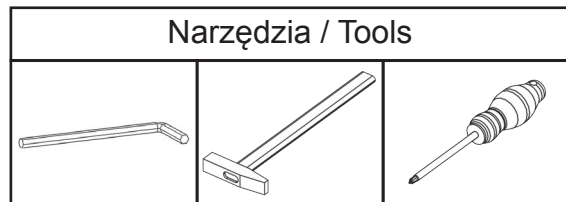

**DO MONTAŻU POTRZEBNE SĄ DWIE OSOBY!
INSTALLATION REQUIRES TWO PEOPLE!**

BARDZO WAŻNE!
NALEŻY UWAŻNIE PRZECZYTAĆ
ZACHOWAĆ DO PÓŹNIEJSZEGO STOSOWANIA

INSTRUKCJA OBSŁUGI

1.

By zapobiec zadławieniu lub uduszeniu opakowanie z akcesoriami należy trzymać w miejscu niedostępnym dla niemowląt i dzieci.

2.

Wszystkie połączenia w meblu muszą być dobrze dokręcone, żaden z elementów łączących nie może być luźny.

3.

Nie należy używać komody jeśli jakikolwiek element jest uszkodzony lub brakuje elementu.

4.

Należy używać tylko elementów dopuszczonych przez producenta.

5.

Nie należy w pobliżu komody umieszczać otwartych źródeł ognia oraz innych silnych źródeł ciepła, jak promienniki gazowe lub elektryczne itp., gdyż grozi to pożarem.

6.

Komodę należy przytwierdzić do ściany za pomocą dołączonej taśmy zabezpieczającej!

VERY IMPORTANT!
PLEASE READ CAREFULLY
SAVE FOR FUTURE USE

USER'S MANUAL

1.

To avoid the danger of choking or strangulation keep the package with fittings away from babies and children.

2.

All connections must be tightened properly and no coupled element can not be loose.

3.

Do not use the commode when, if any of the elements is damaged or if there is any element missing.

4.

Use only the elements given by manufacturer.

5.

Do not place the commode near naked flames or other heat sources such as electric or gas radiators etc., this may cause a fire.

6.

The commode must be fixed to the wall using the supplied roll-over protection tape!

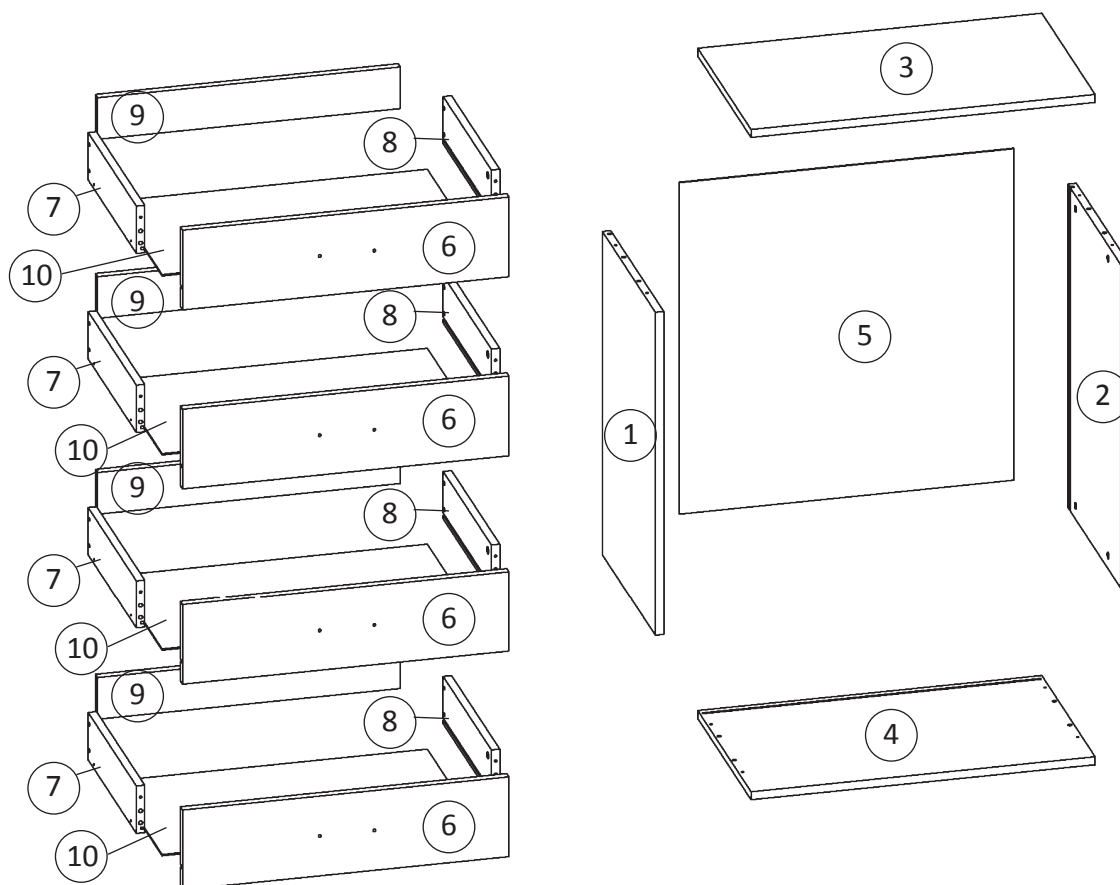

Paczka 1 z 1 / Package 1 of 1

Numer elementu / item no.	Wymiary (mm)/ Dimensions (mm)	Ilość / Quantity
1	760 x 440 x 18	1
2	760 x 440 x 18	1
3	884 x 442 x 18	1
4	884 x 442 x 18	1
5	431 x 778 x 3	1
6	842 x 252 x 18	4
7	400 x 202 x 18	4
8	400 x 202 x 18	4
9	785 x 184 x 18	4
10	803 x 404 x 3	4

PRZED MONTAŻEM MEBLA NALEŻY DOKŁADNIE SPRAWDZIĆ CZY PACZKI ZAWIERAJĄ WSZYSTKIE ELEMENTY WYSZCZEGÓLNIONE W TABELCE NA STRONIE 3 ORAZ CZY ELEMENTY TE NIE SĄ USZKODZONE !!! JEŚLI BRAKUJE ELEMENTÓW LUB NIEKTÓRE Z NICH SĄ USZKODZONE PROSIMY O KONTAKT Z NASZYM BIUREM OBSŁUGI KLIENTA.

USZKODZENIA ELEMENTÓW STWIERDZONE JUŻ PO MONTAŻU MEBLA NIE BĘDĄ UWZGLĘDNIANE !!!

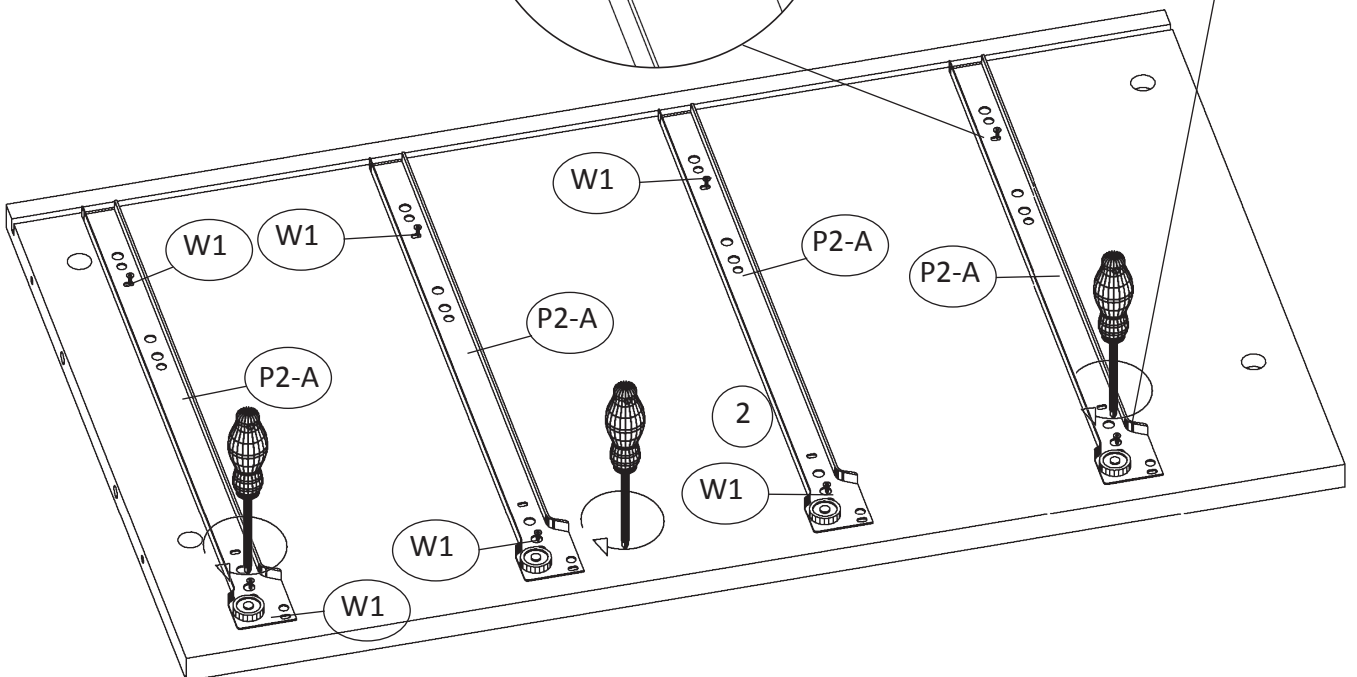
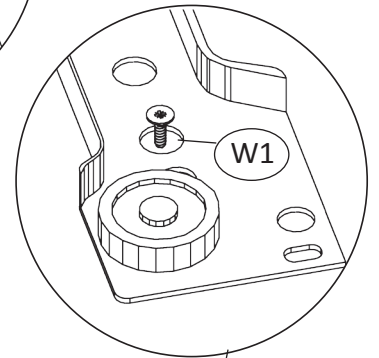
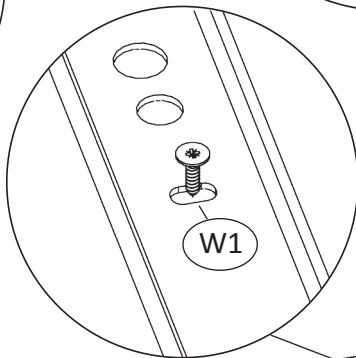
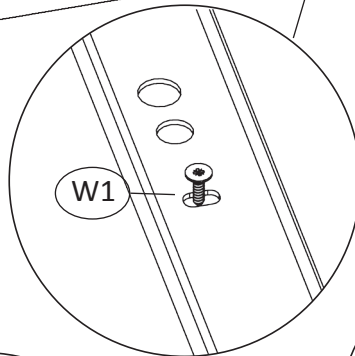
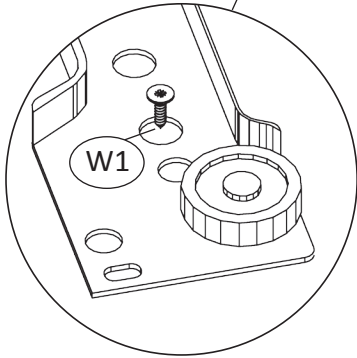
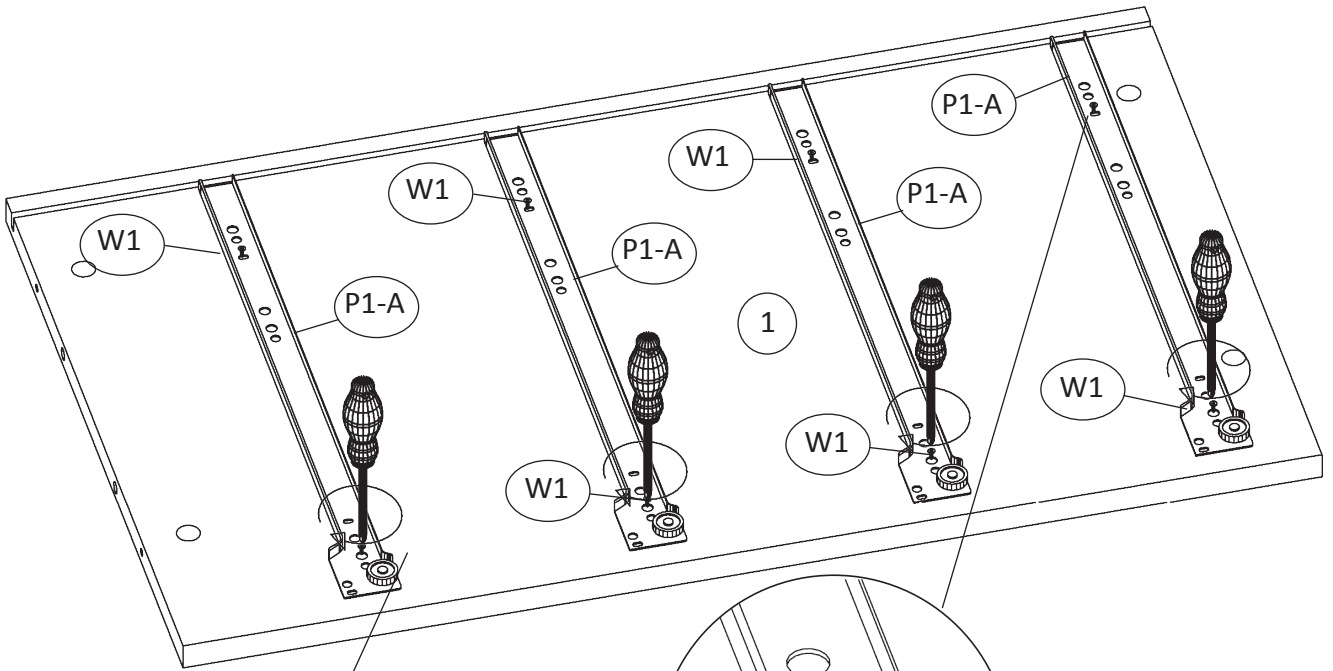
BEFORE ASSEMBLING THE FURNITURE PLEASE CHECK THAT PACKAGES INCLUDE ALL ITEMS LISTED IN THE TABLE ON PAGE NO 3, AND WHETHER THESE ITEMS ARE NOT DAMAGED !!!
IF MISSING PARTS OR SOME OF THEM ARE DAMAGED, PLEASE CONTACT OUR CUSTOMER SERVICE OFFICE.
DAMAGES FOUND AFTER ASSEMBLING WILL NOT BE CONSIDERED !!!



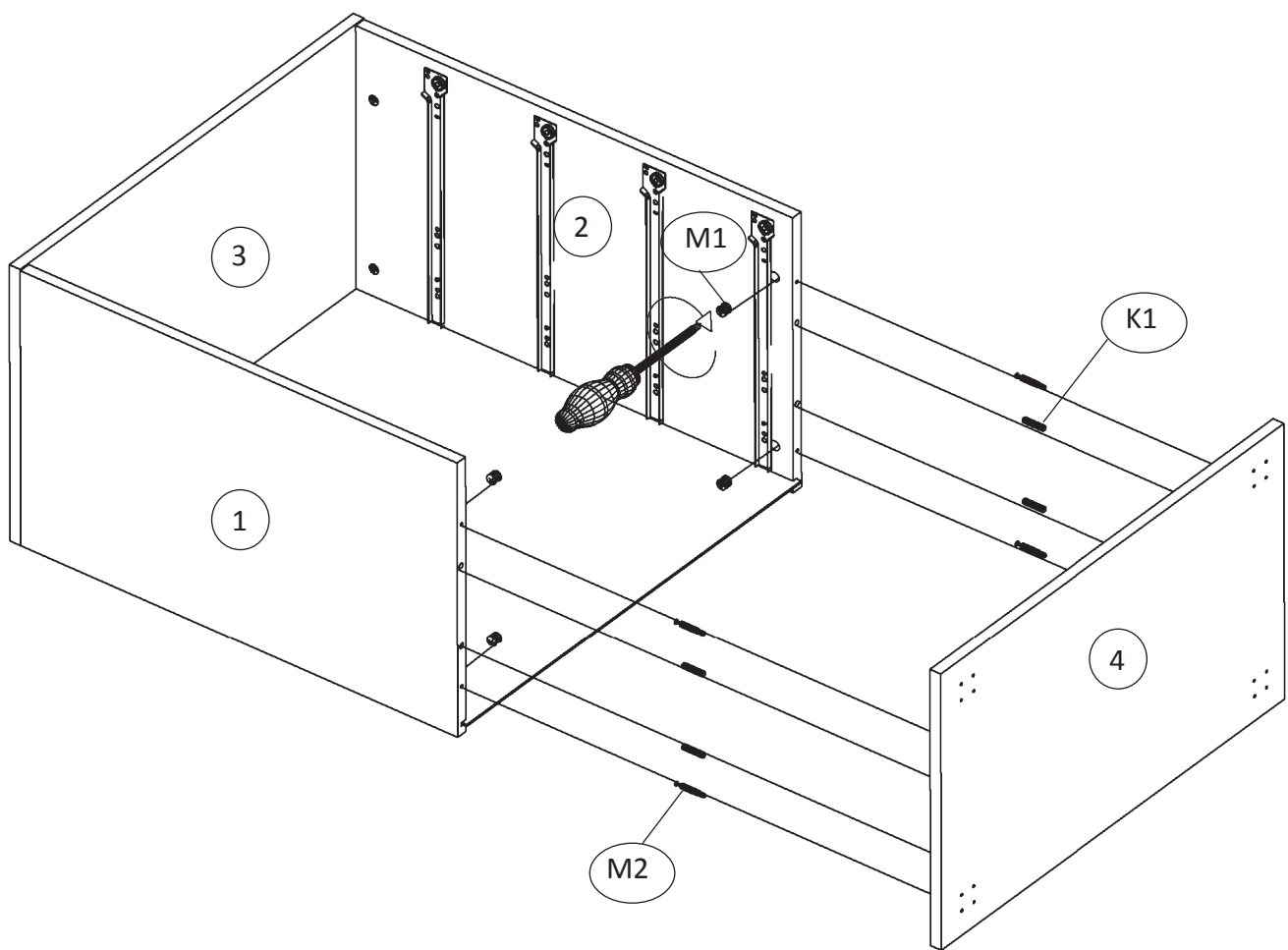
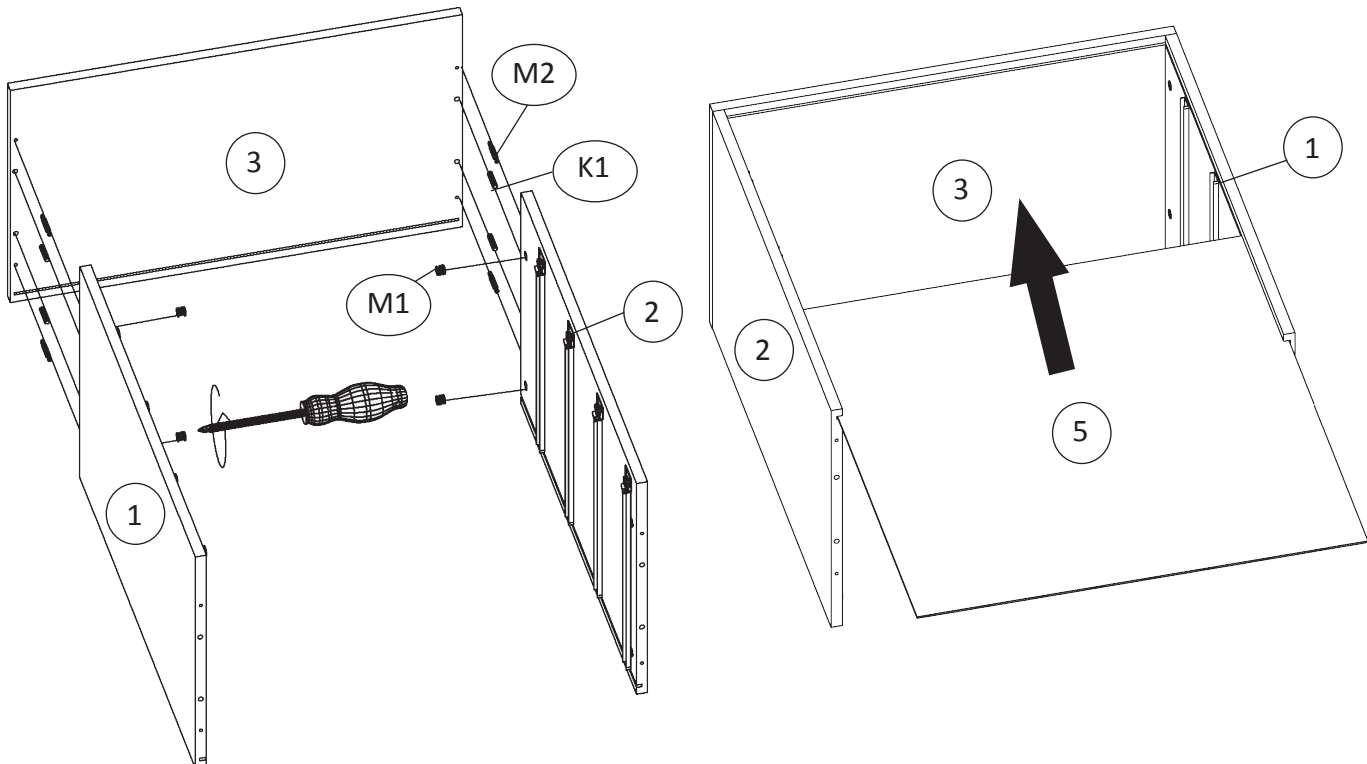

A=B

A

B

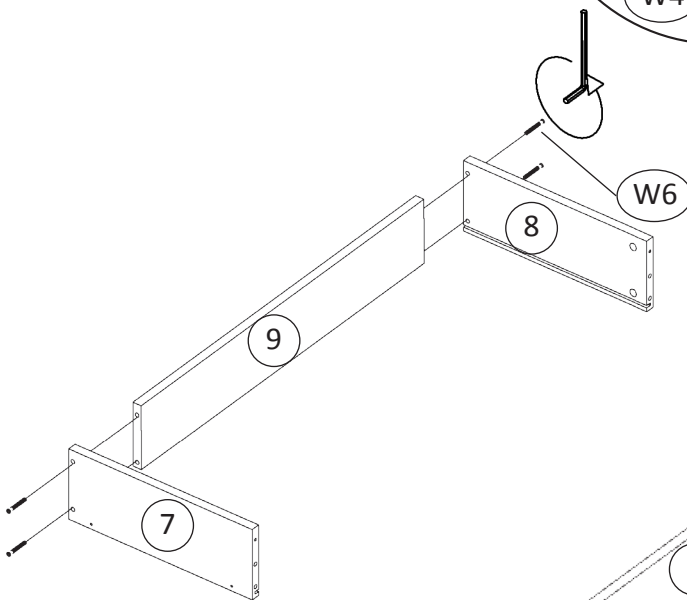
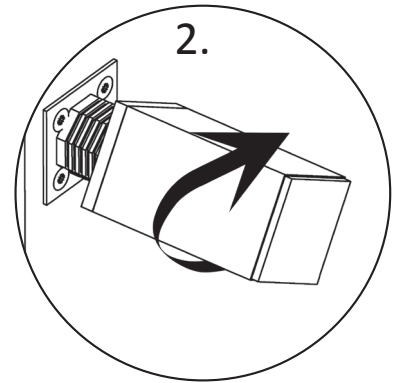
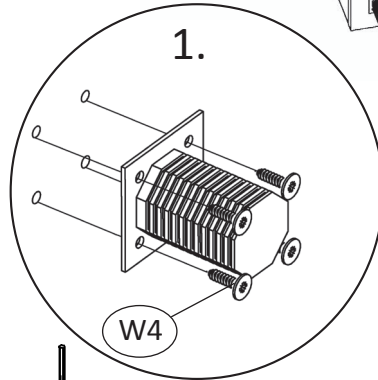
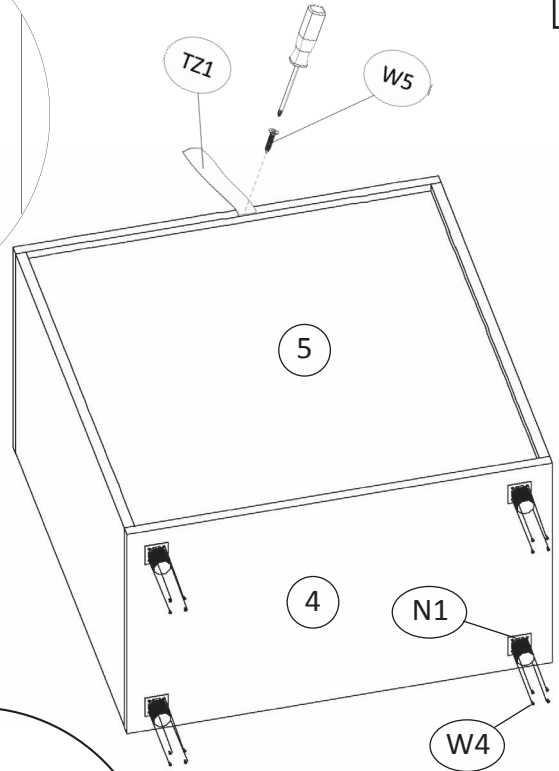
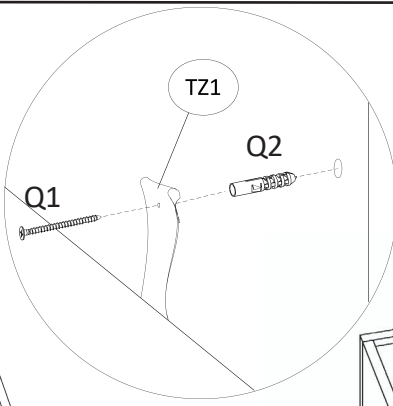
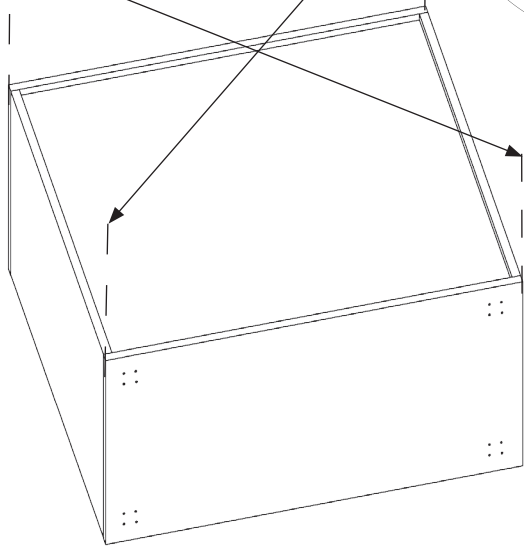

x3

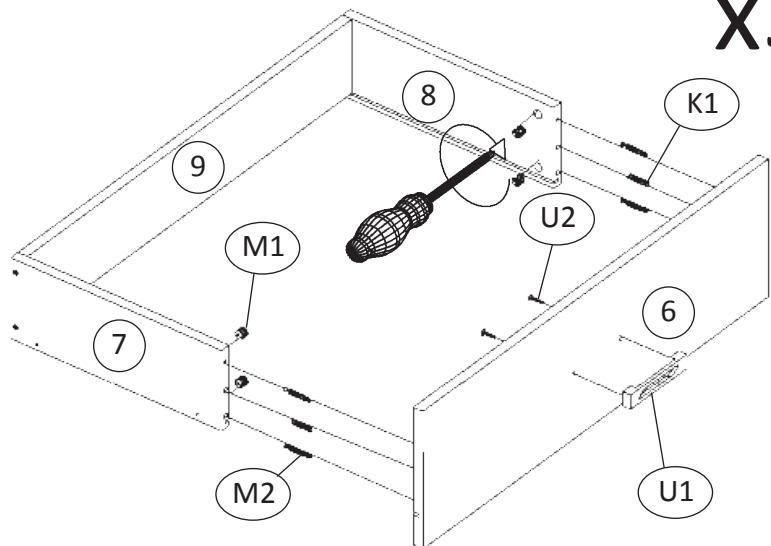

x3

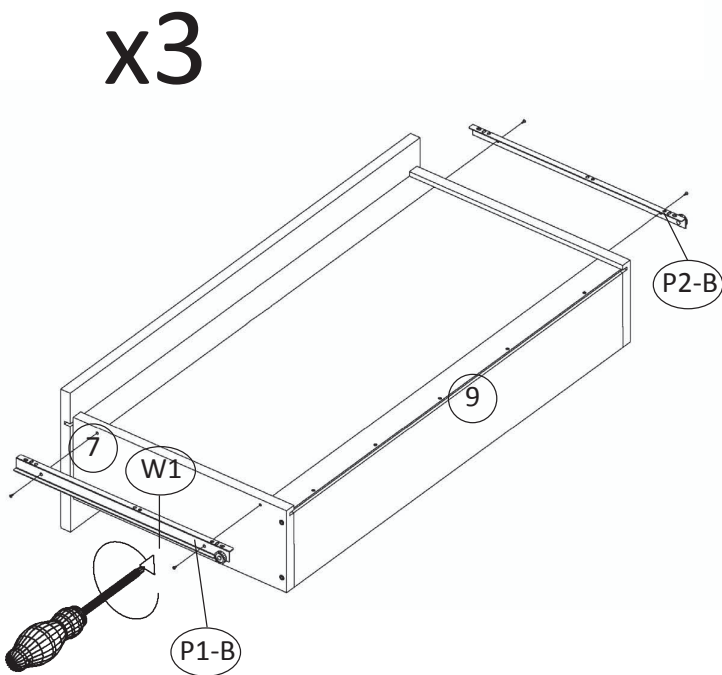
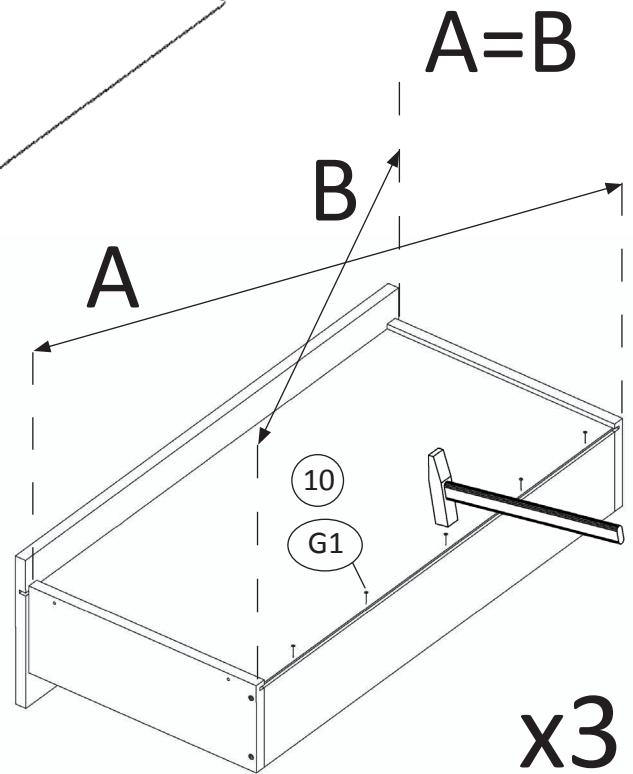
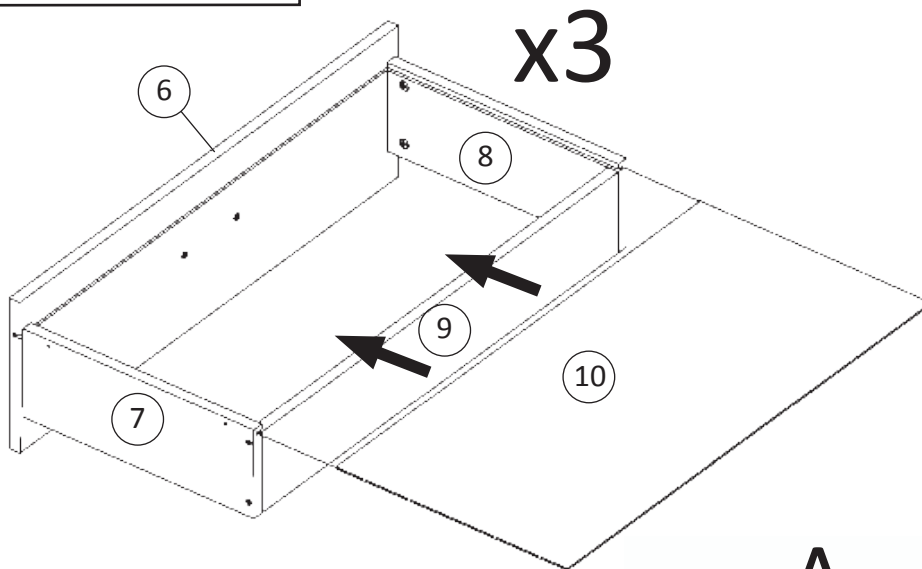

Na widocznych śrubach (W6) należy umieścić dostarczone zaślepki samoprzylepne (ZW1).

On the visible screws (W6) should be placed supplied adhesive caps (ZW1).

Na mimośrodach (M1) należy umieścić dostarczone plastikowe zaślepki (ZM1).

On the eccentrics (M1) should be placed supplied plastic caps (ZM1).

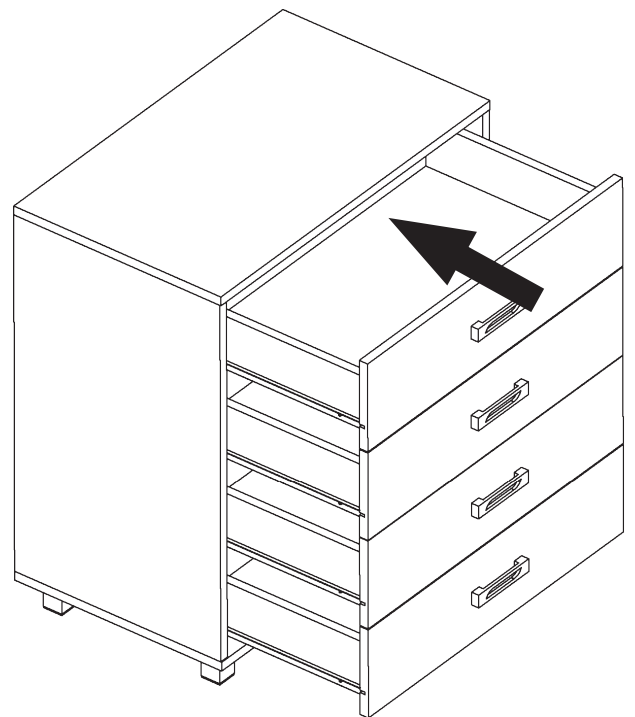

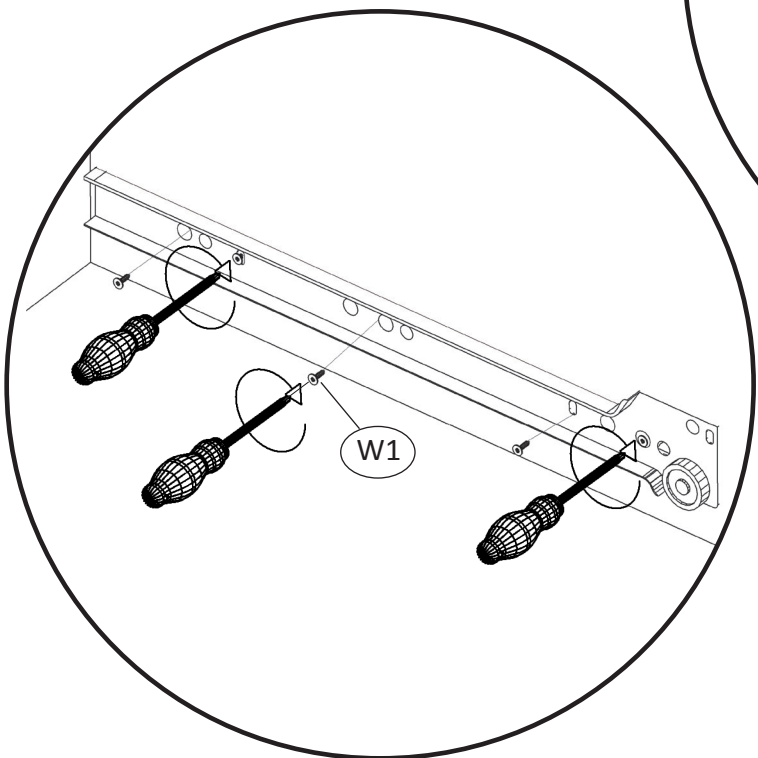
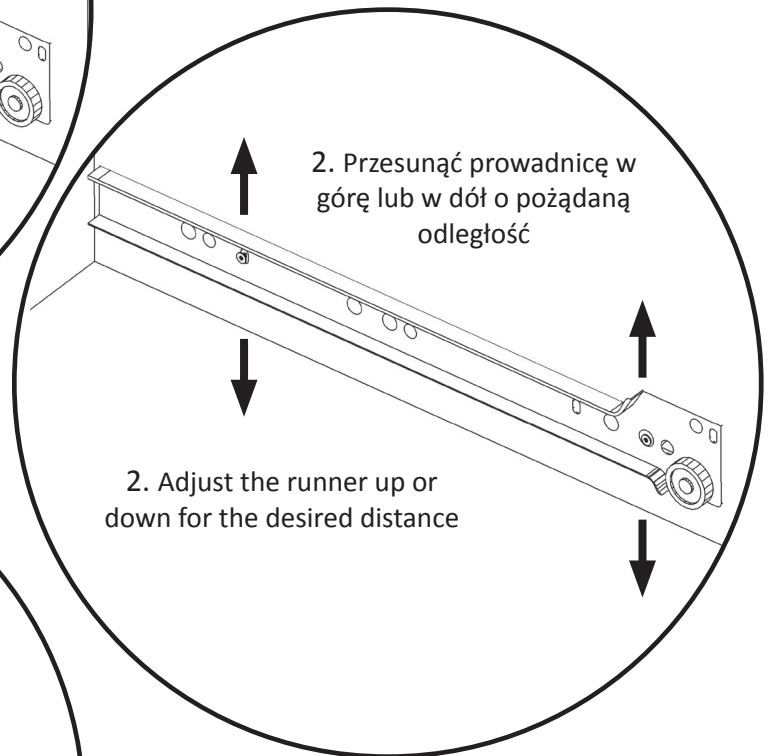
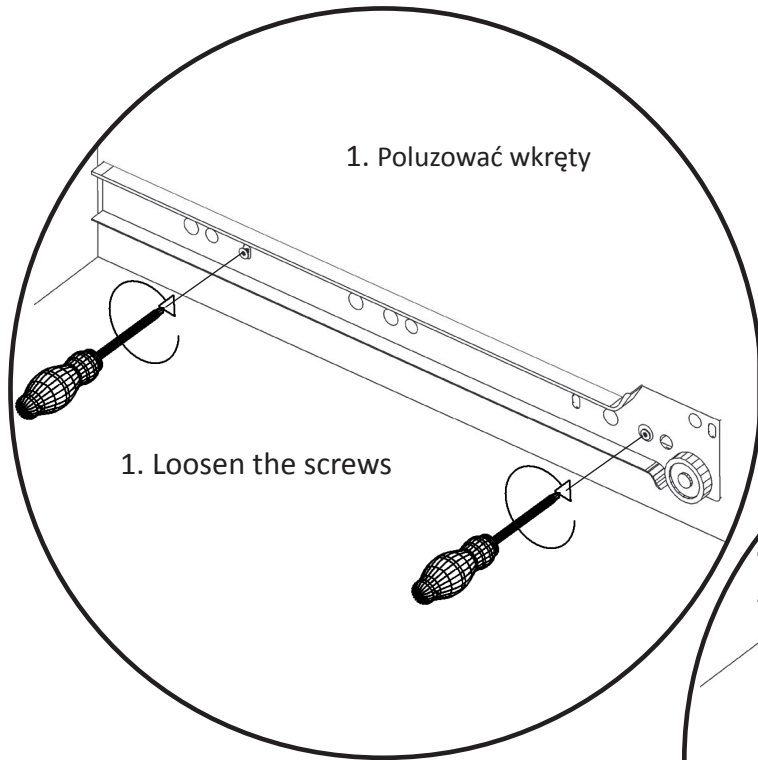

3. Dokręcić poluzowane wcześniej wkręty.
4. Wsunąć szuflady i sprawdzić ich położenie.
5. Jeśli szuflady leżą prawidłowo wkręcić dla stabilizacji kolejne 3 wkręty.

3. Tighten the screws loosened earlier.

4. Slide the drawer and check their positions.

5. If the drawers are mounted properly tighten another 3 screws to stabilize each drawer runner.

W razie konieczności czynności powtórzyć.

If necessary, repeat the steps.