

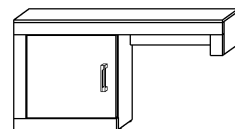

# VRN-04 VERIN - REGAŁ RTV

► 120 ▲ 65 ▼ 34

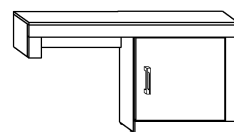

x 20

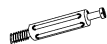

x 4



x 24



x 11



x 2

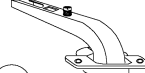

(a)

(b)

(c)

(d)

(e)

x 2

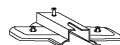

x 1

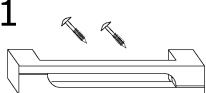

x 3

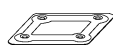

x 4



(f)

(g)

(h)

(i)

x 4



x 16 (3,5x16)



x 25

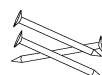

(j)

(k)

(l)

35 min

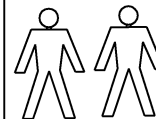

1 - FAZY MONTAŻU

A - OZNACZENIE ELEMENTÓW

a - OZNACZENIE AKCESORIÓW

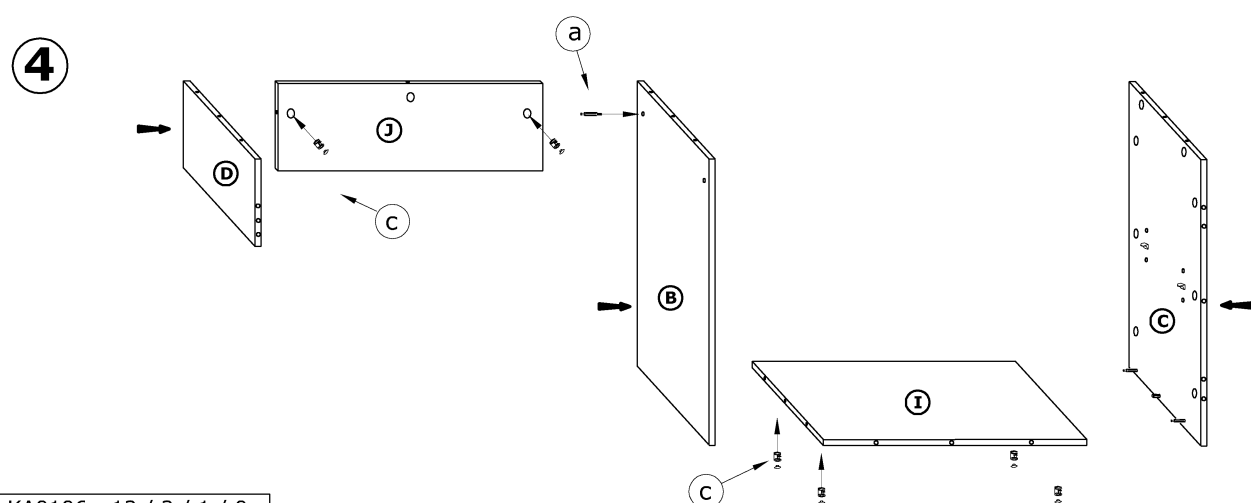
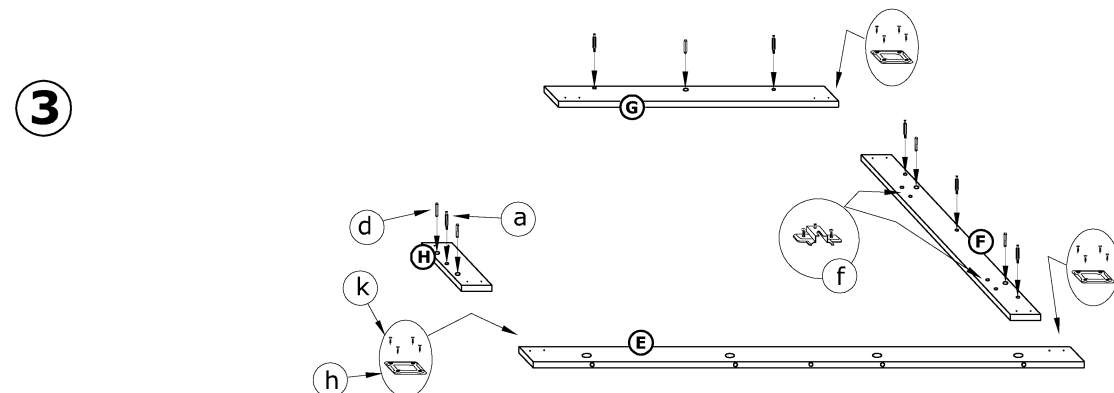
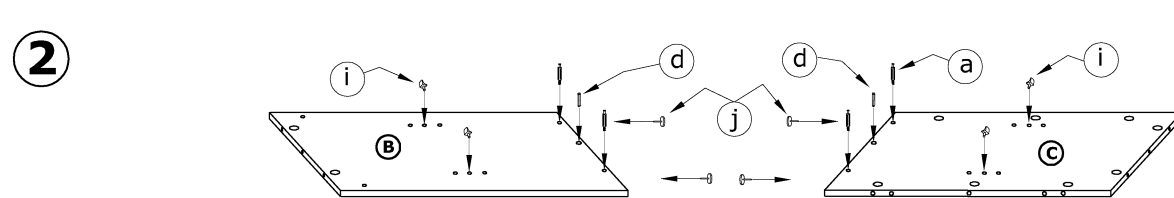
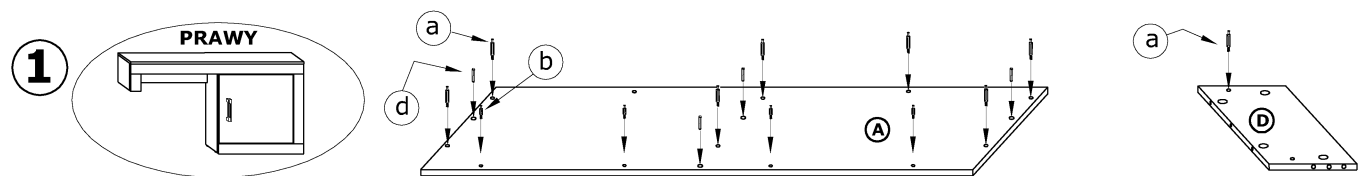

5

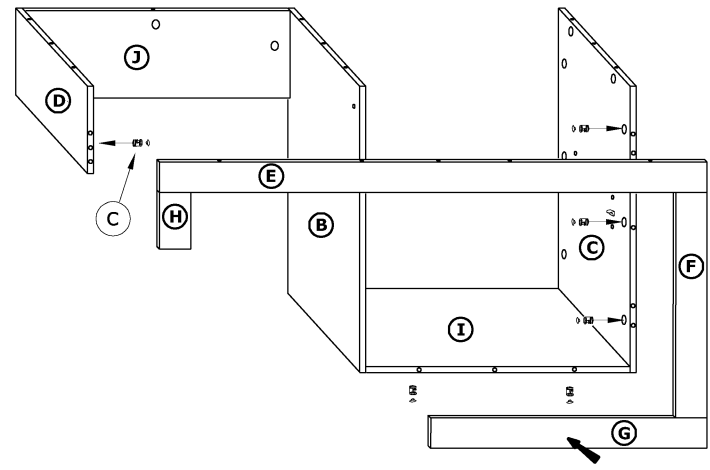

6

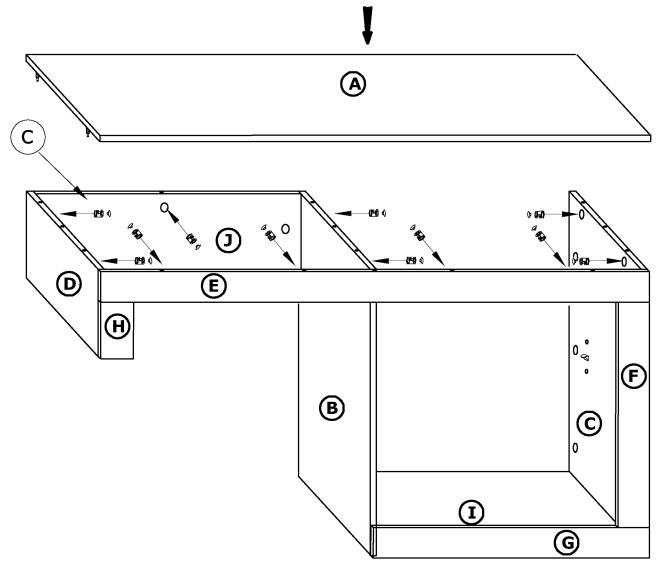

7

