

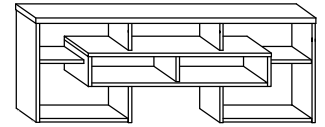

RIO-20 STOLIK RTV

→ 127 ↑ 48 ↘ 38



x 15



(a)

x 30



(b)

x 30



(c)

x 14



(d)

x 8



(e)

x 1

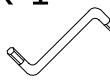

(f)

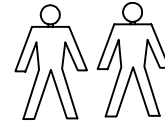
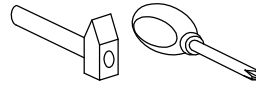

30 min



1 - FAZY MONTAŻU

A - OZNACZENIE ELEMENTÓW

a - OZNACZENIE AKCESORIÓW

1

x 7



(a)

x 14



(b)

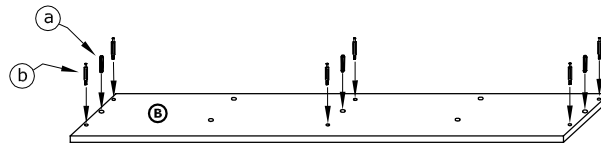
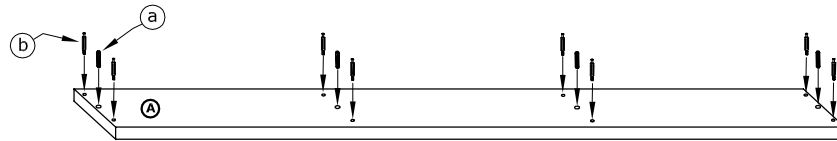

2

x 8



(a)

x 16



(b)

x 8



(e)

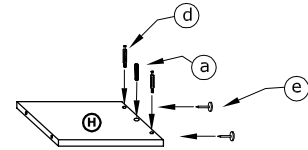
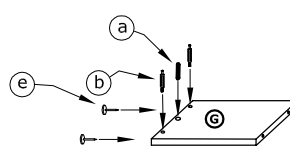
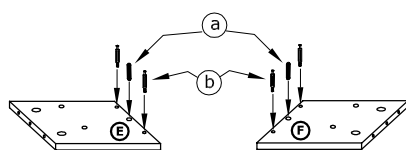
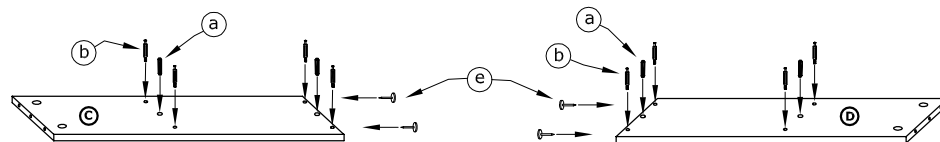

3

x 4



(c)

x 10



(d)

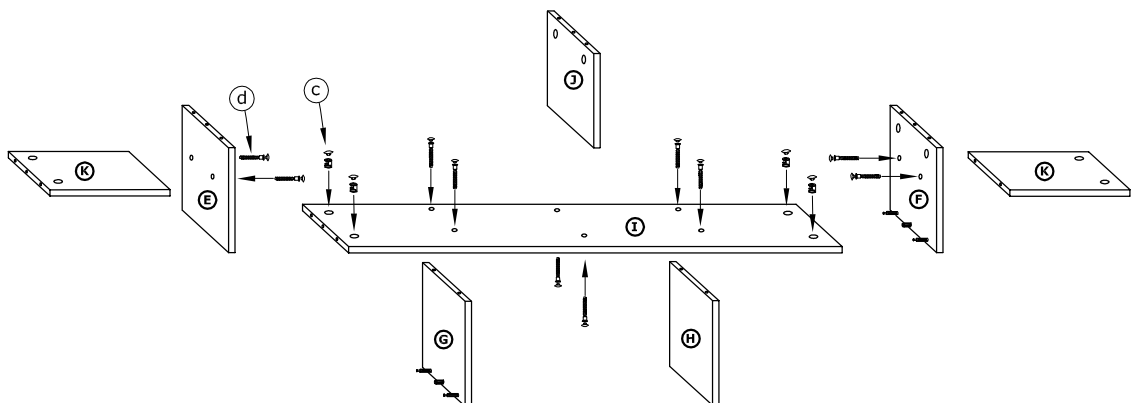

4

x 6

x 4

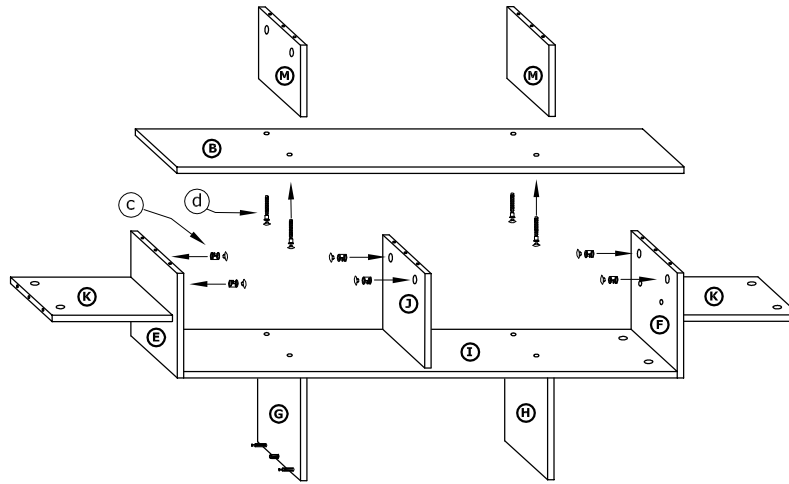
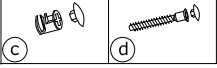

5

x 12

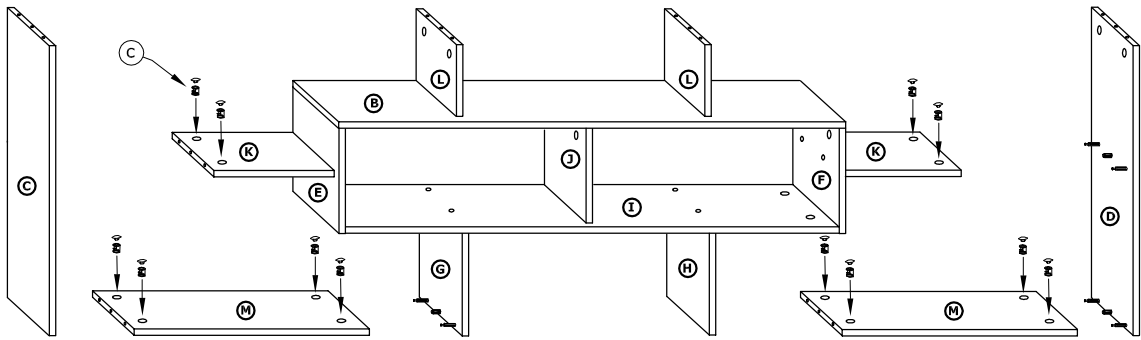
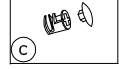

6

x 8

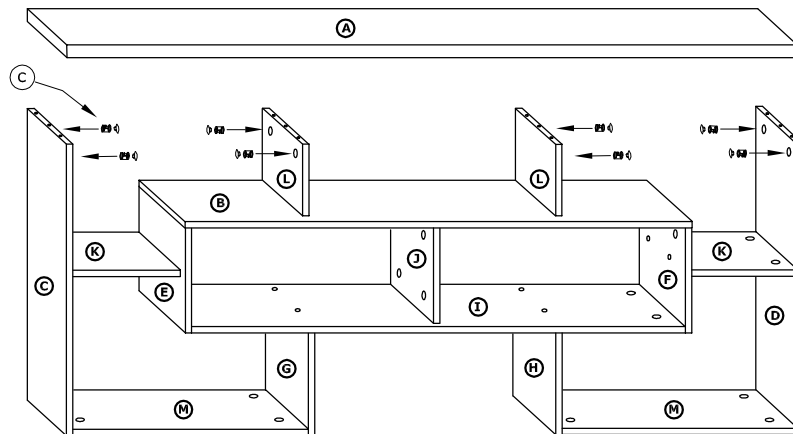
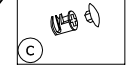



RIO-14 PÓŁKA

→ 127 + 50 × 26

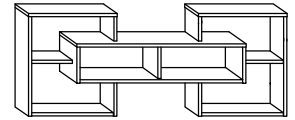

x 12



(a)

x 32



(b)

x 32



(c)

x 15



(d)

x 3 kpl.

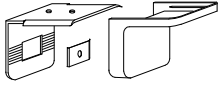

(e)

x 6
(6,2x13)



(f)

x 1



(g)

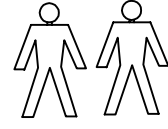
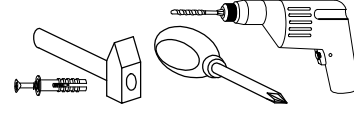

30 min



1 - FAZY MONTAŻU

A - OZNACZENIE ELEMENTÓW

a - OZNACZENIE AKCESORIÓW

1

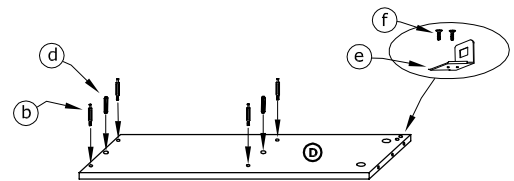
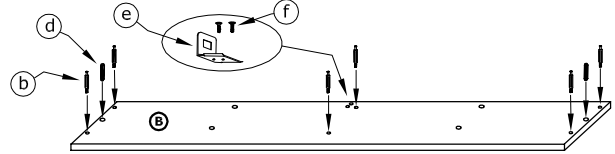
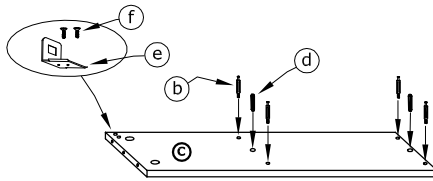
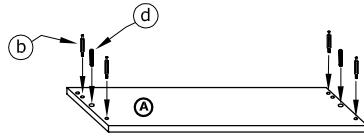
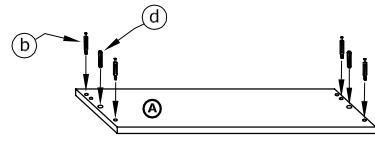
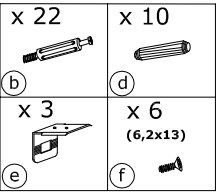

2

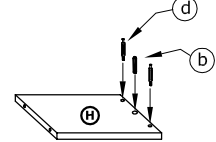
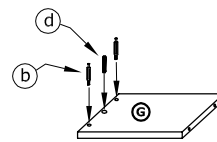
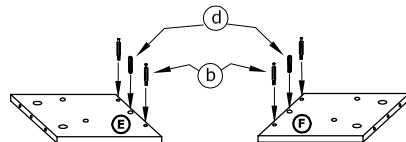
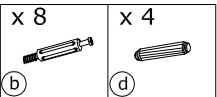

3

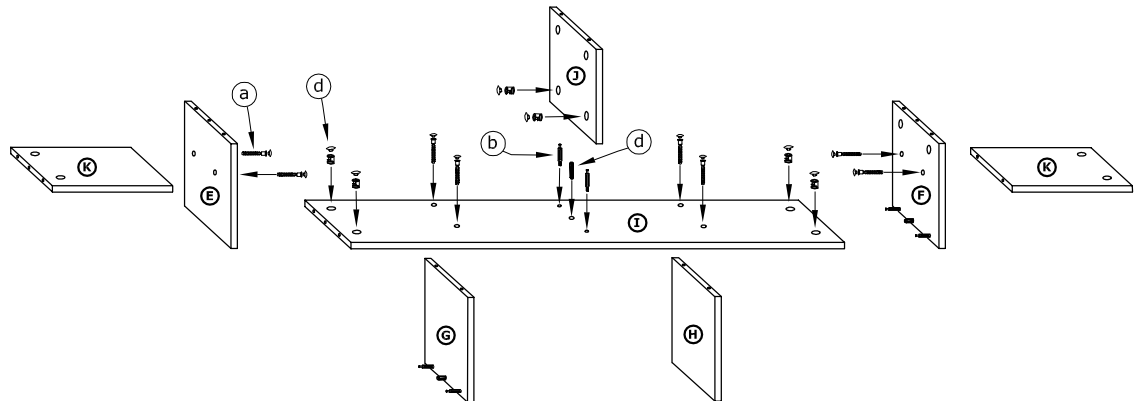
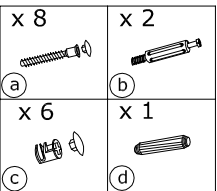

4 x 4 x 6

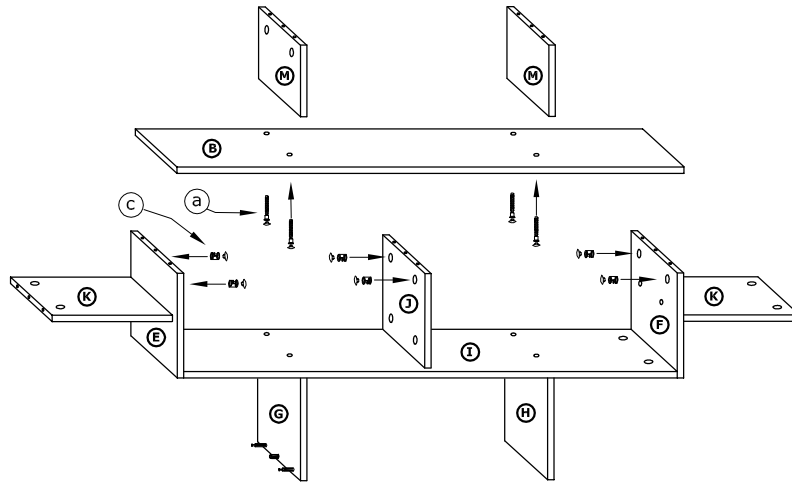
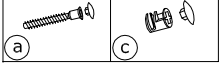

5 x 12

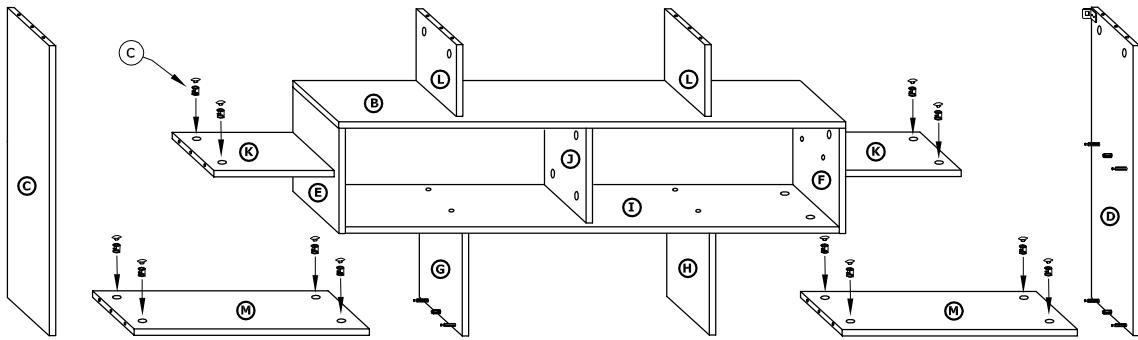

6 x 8

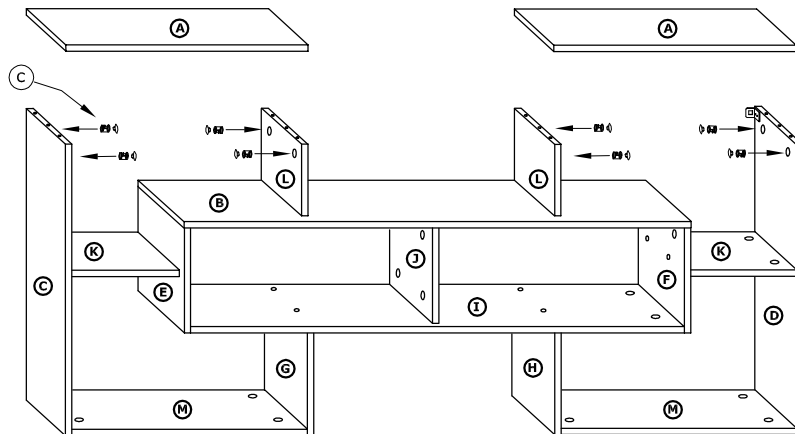



RIO-08 KOMODA L1D

→ 64 186 41

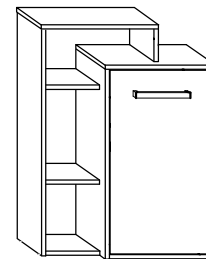

x 9 	x 18 	x 18 	x 8 	x 2 	x 2 	
x 9 	x 6 	x 4 (3,5x16) 	x 1 	x 30 	x 1 	



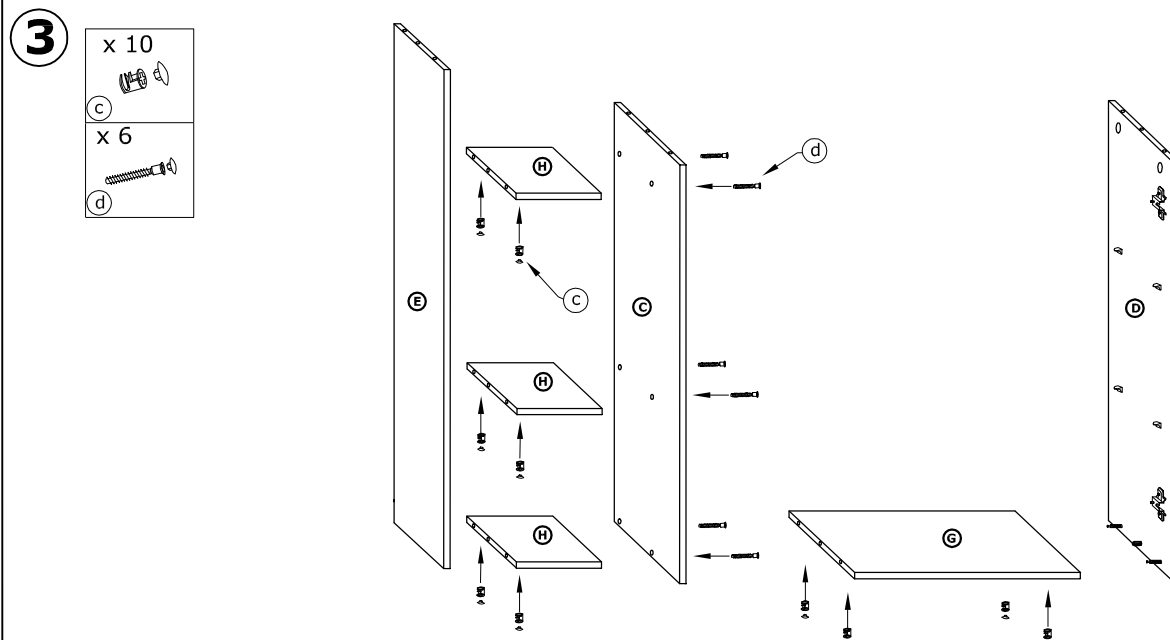
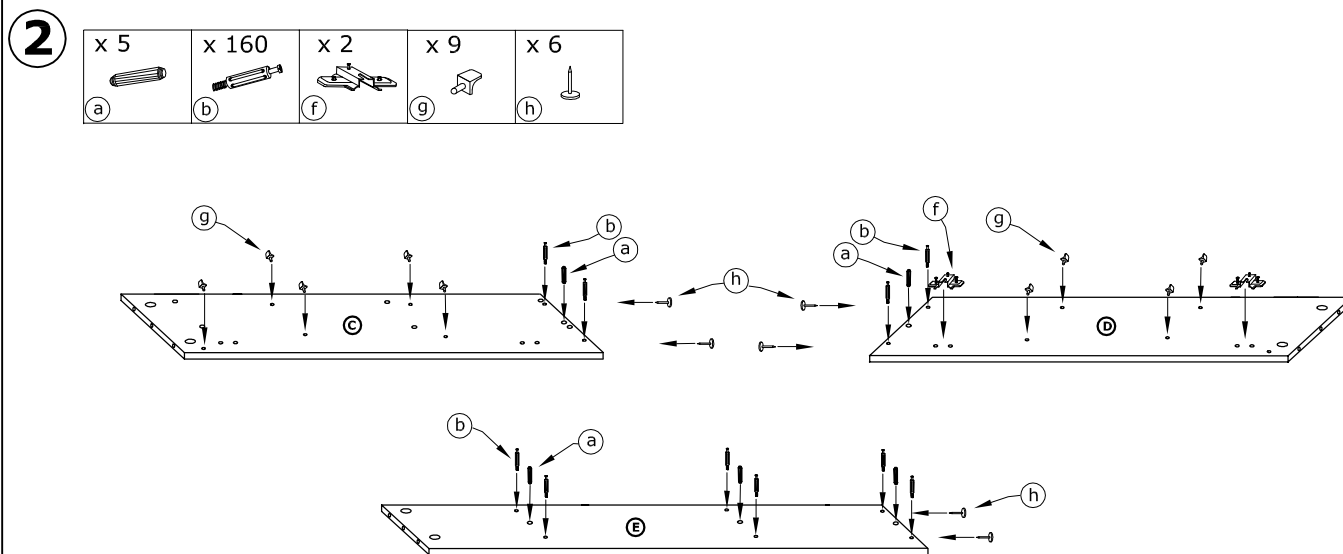
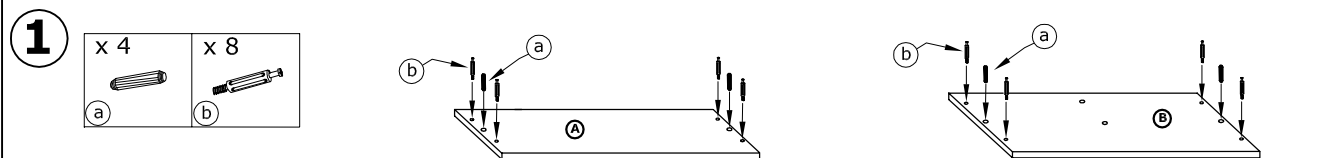

1 - FAZY MONTAŻU

A - OZNACZENIE ELEMENTÓW

a - OZNACZENIE AKCESORIÓW



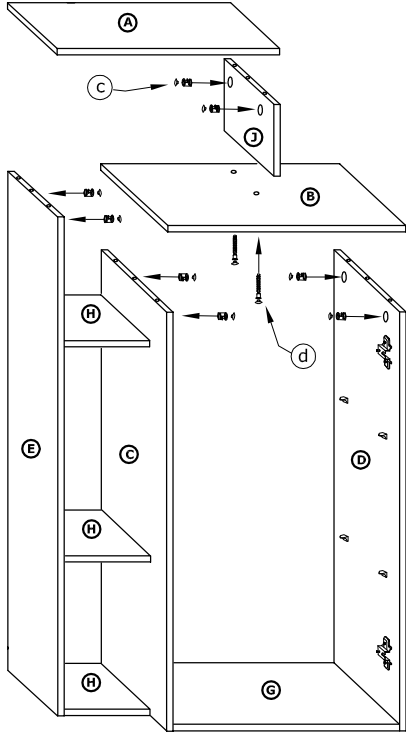

4

- x 8 
- (c) 
- x 2 
- (d) 







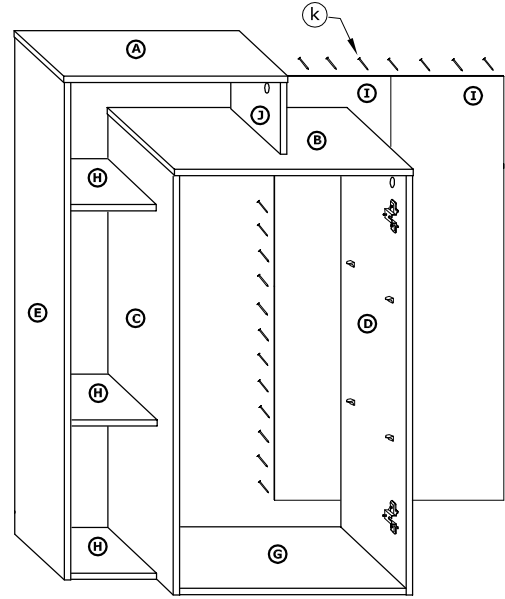

5

- x 30 
- (k) 

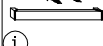

6

- x 2 
(e) 
- x 4 (3,5x16) 
(i) 
- x 1 
(j) 

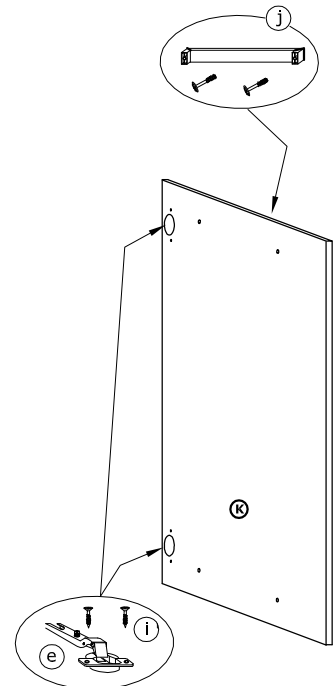
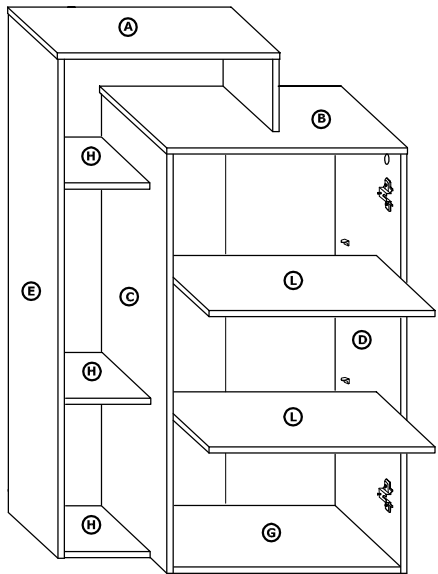



RIO-02
BIELIŹNIARKA P
 → 64 ↑ 203 ↓ 41

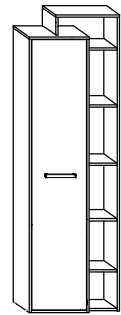

x 14 (a)	x 28 (b)	x 28 (c)	x 14 (d)	x 3 (e)	x 3 (f)	
x 13 (g)	x 6 (h)	x 6 (3,5x16) (i)	x 1 (j)	x 50 (k)	x 1 (l)	

1 - FAZY MONTAŻU

A - OZNACZENIE ELEMENTÓW

a - OZNACZENIE AKCESORIÓW

1

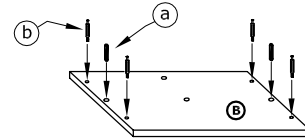
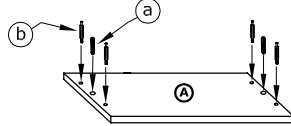
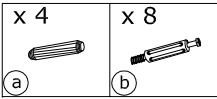

2

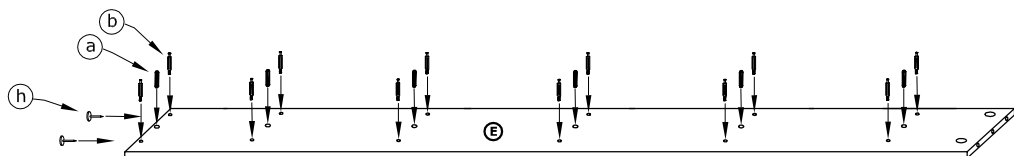
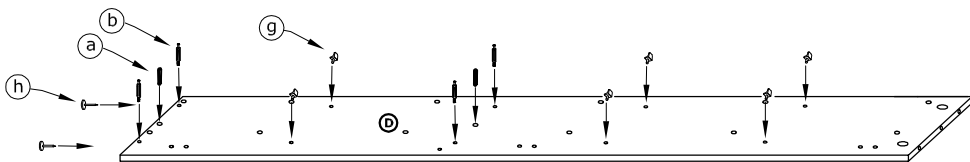
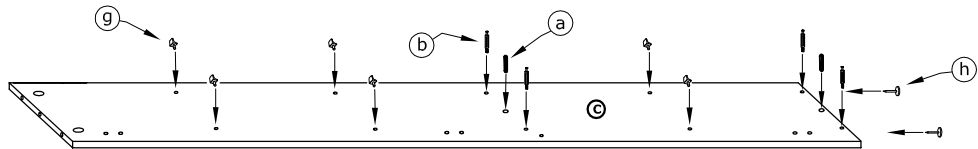
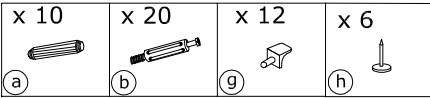

3

- x 20
- (c)
- x 12
- (d)

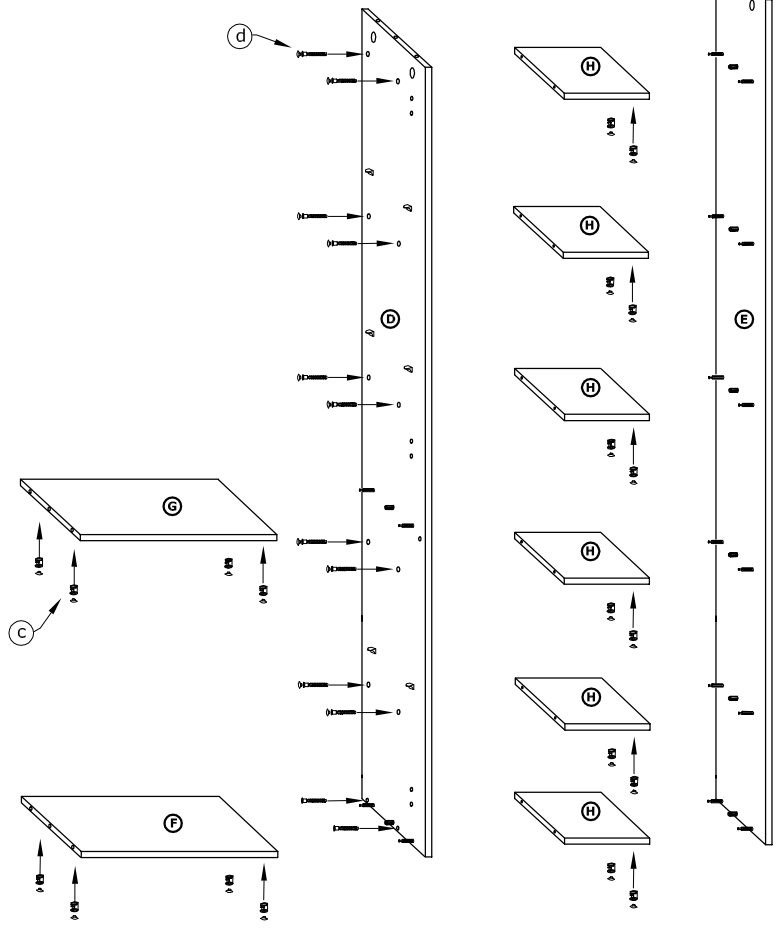
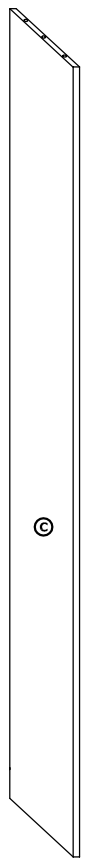



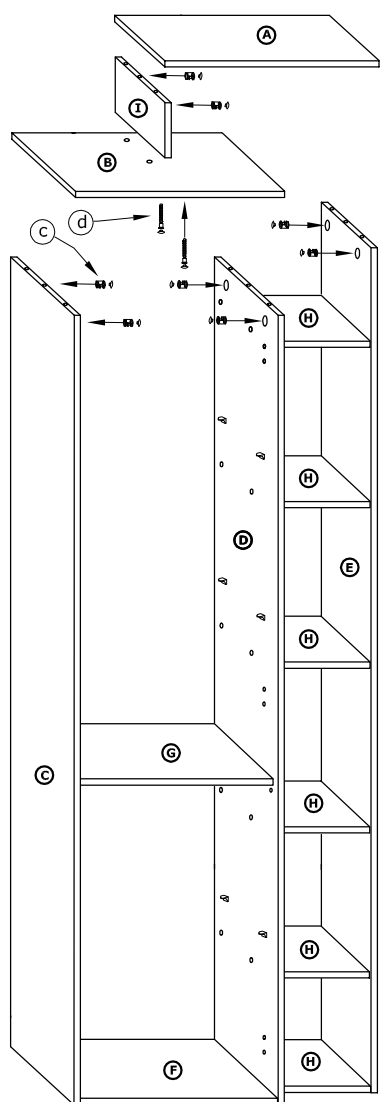

4

- x 8
- (c)
- x 2
- (d)



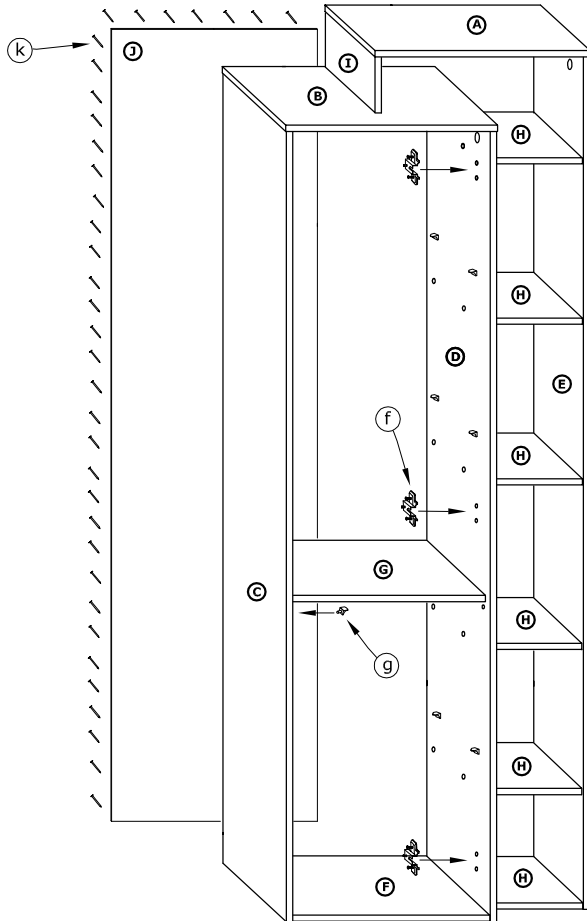

5

- x 3

- (f)
x 1

- (g)
x 50

- (k)



6

- x 3

- (e)
x 6
(3,5x16)

- (i)
x 1

- (j)
