

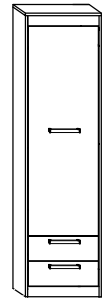

MXS-01

BIELIŹNIARKA 1D2S

→ 52+193\36



x 8 	x 22 	x 2 	x 24 	x 8 	x 4 				
x 3 	x 3 	x 8 	x 4 	x 4 	x 38 (3,5x16) 			x 8 (3,5x30) 	x 80
x 1 	x 3 		x 2 kpl. (300 mm) 		 40 min 				

1 - FAZY MONTAŻU

A - OZNACZENIE ELEMENTÓW

a - OZNACZENIE AKCESORIÓW

1

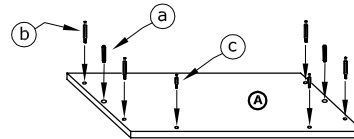
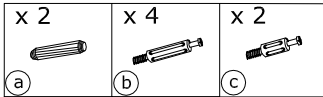

2

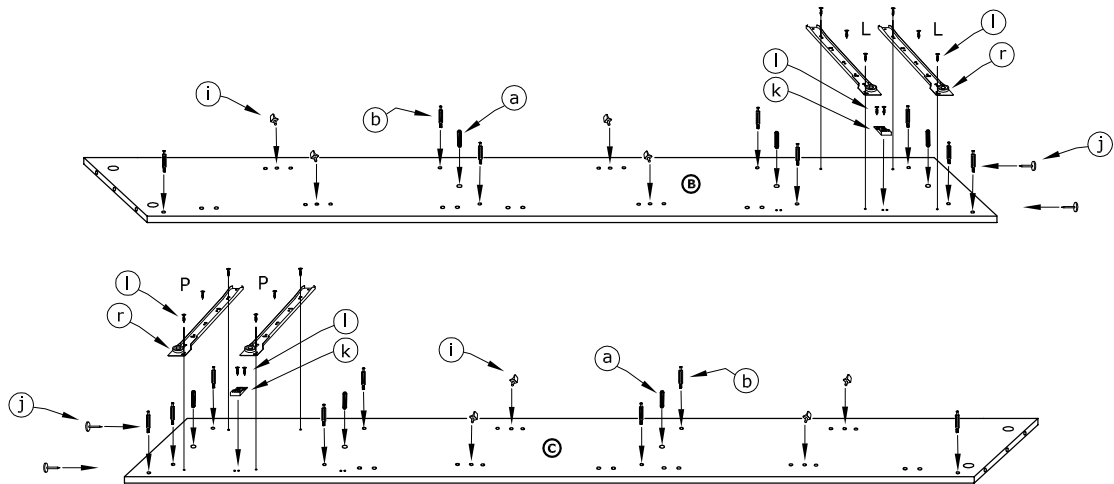
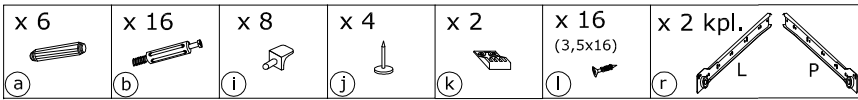

3

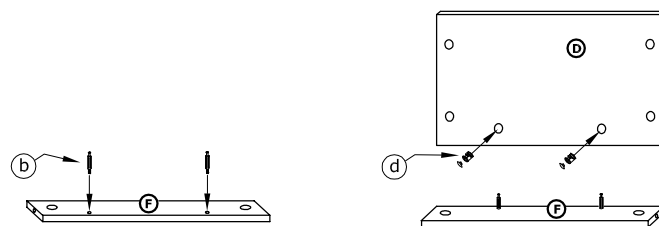
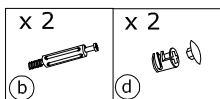

4

x 16
d

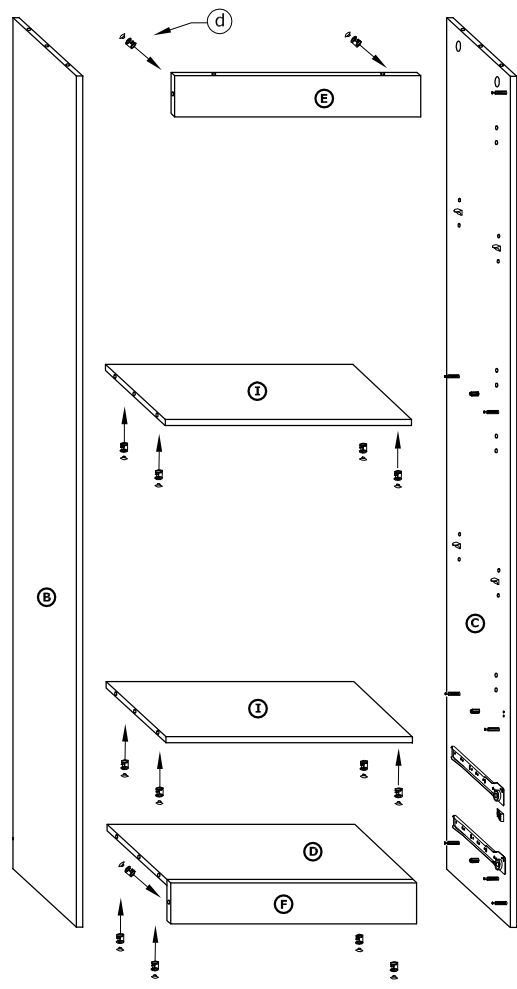

5

x 6
d
x 50
n

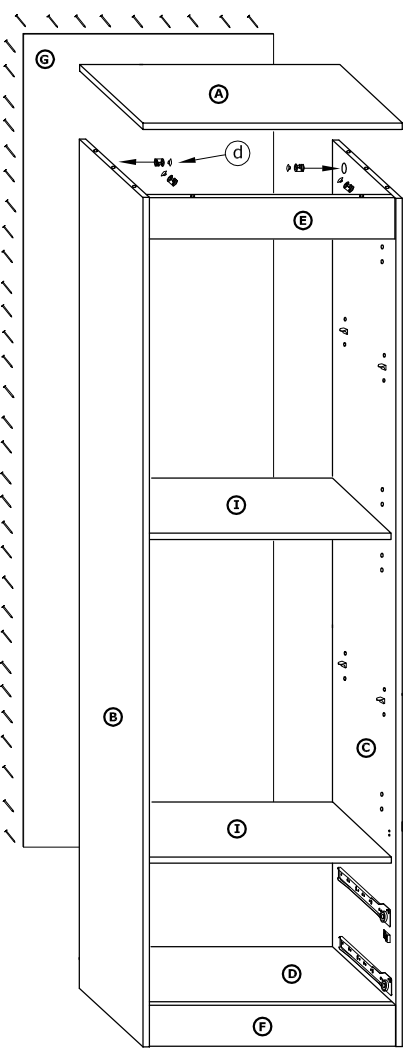

6

x 8 e	x 4 f	x 12 (3,5x16) l	x 4 (3,5x30) m
x 30 n	x 2 kpl. r	L	

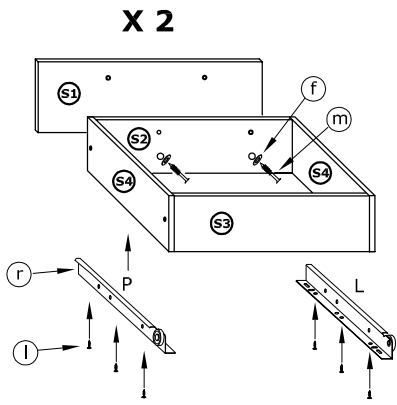
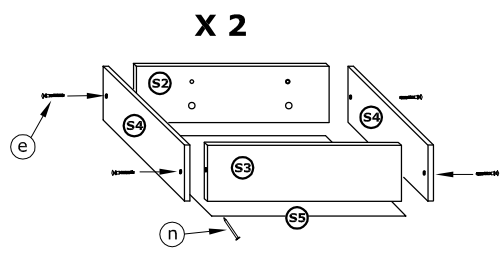

7

x 3 g
x 3 h
x 2 k
x 10 (3,5x16) l
x 4 (3,5x30) m
x 3 p

