

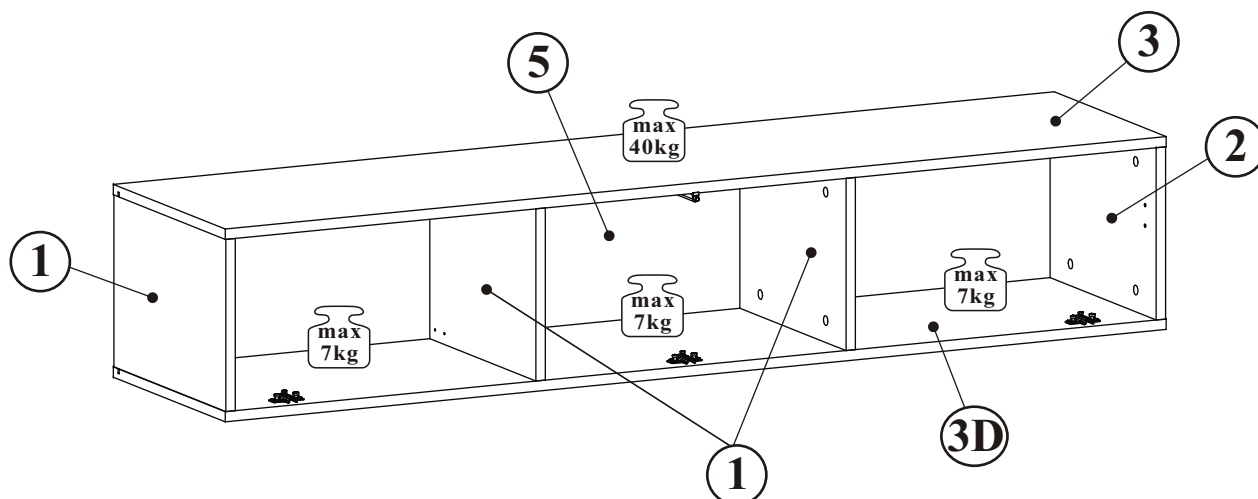

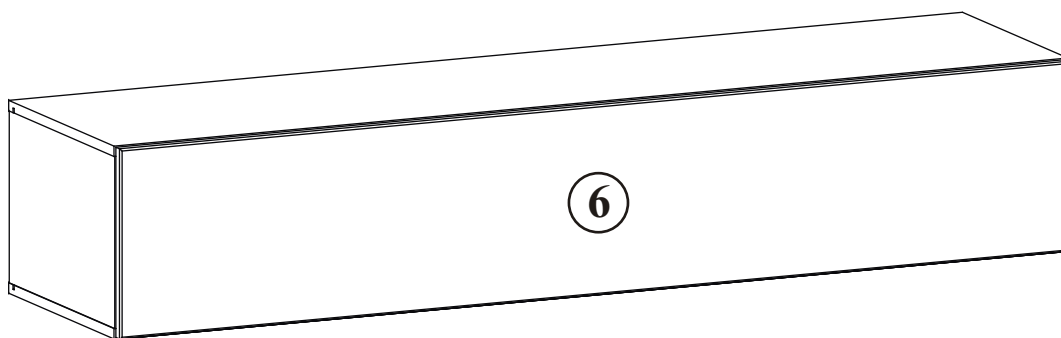

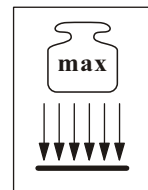

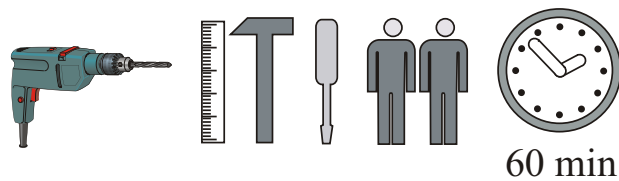

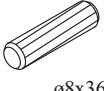
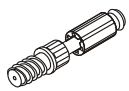

FLY 28 -- FY 30-C

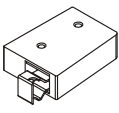

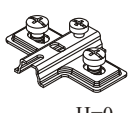
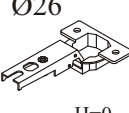
NO	Dim.		Col.-No	Qty
1	268	384	1	1
2	268	384	1	1
3	1602	384	1	1
3D	1602	384	1	1
4	268	364	1	2
5	1580	280	1	1
6	1596	296	1	1

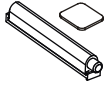

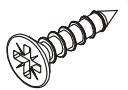
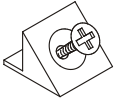
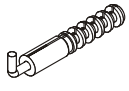
FLY 28--FY 30-C

A1 x16  ø8x36	B4 x16 	B5 x16  ø15x12	G5 x16 	ZR1 x4 	D6 x8  USØ3,5x30
E2 x3  H=0	E1 x3  Ø26 H=0	D10 x24  USØ3,5x13	AM x1 	G21 x2 	D7 x6  USØ3x16
S1 x12 	KR2 x4 	G2 x1 			

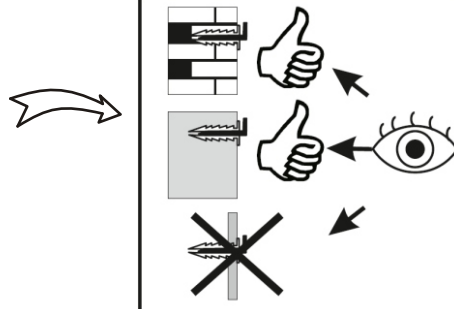
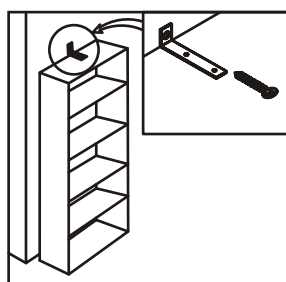
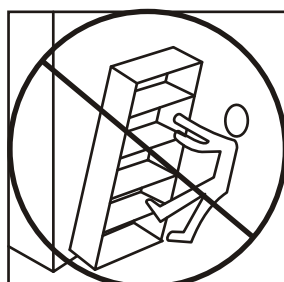
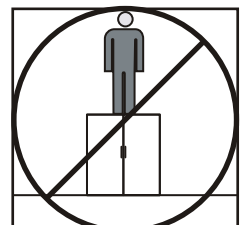
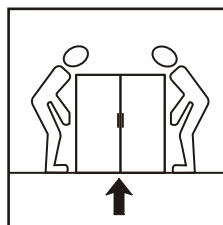
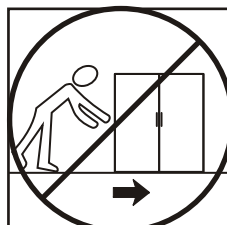
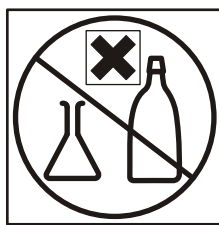
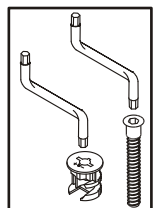
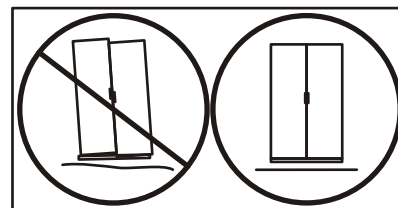
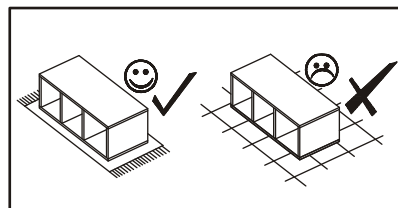
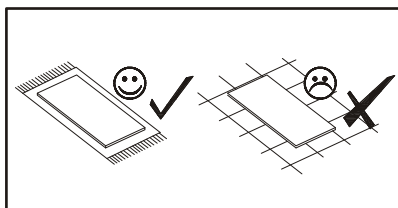
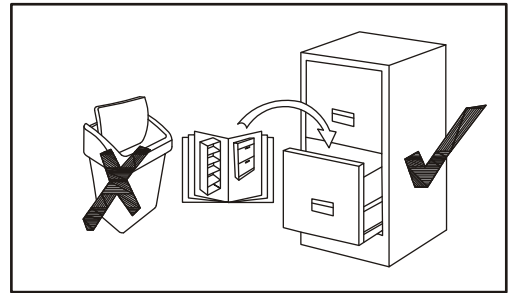
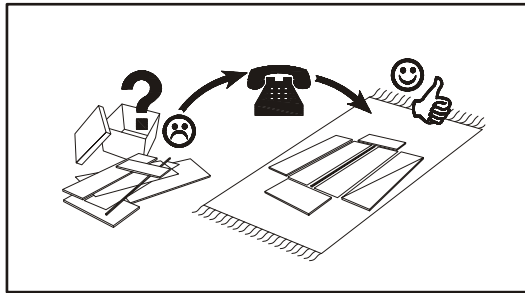
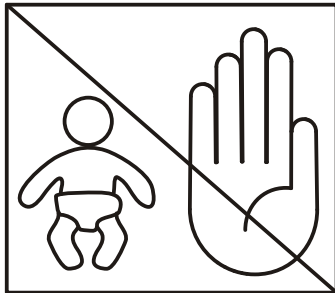
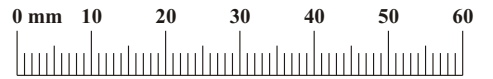

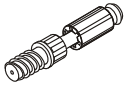
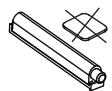
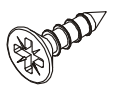
B4		AM		D10	
x8		x1		x2	US03,5x13

1

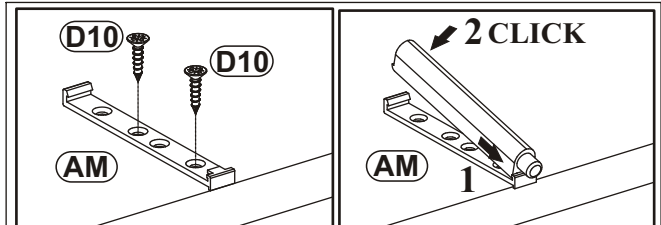
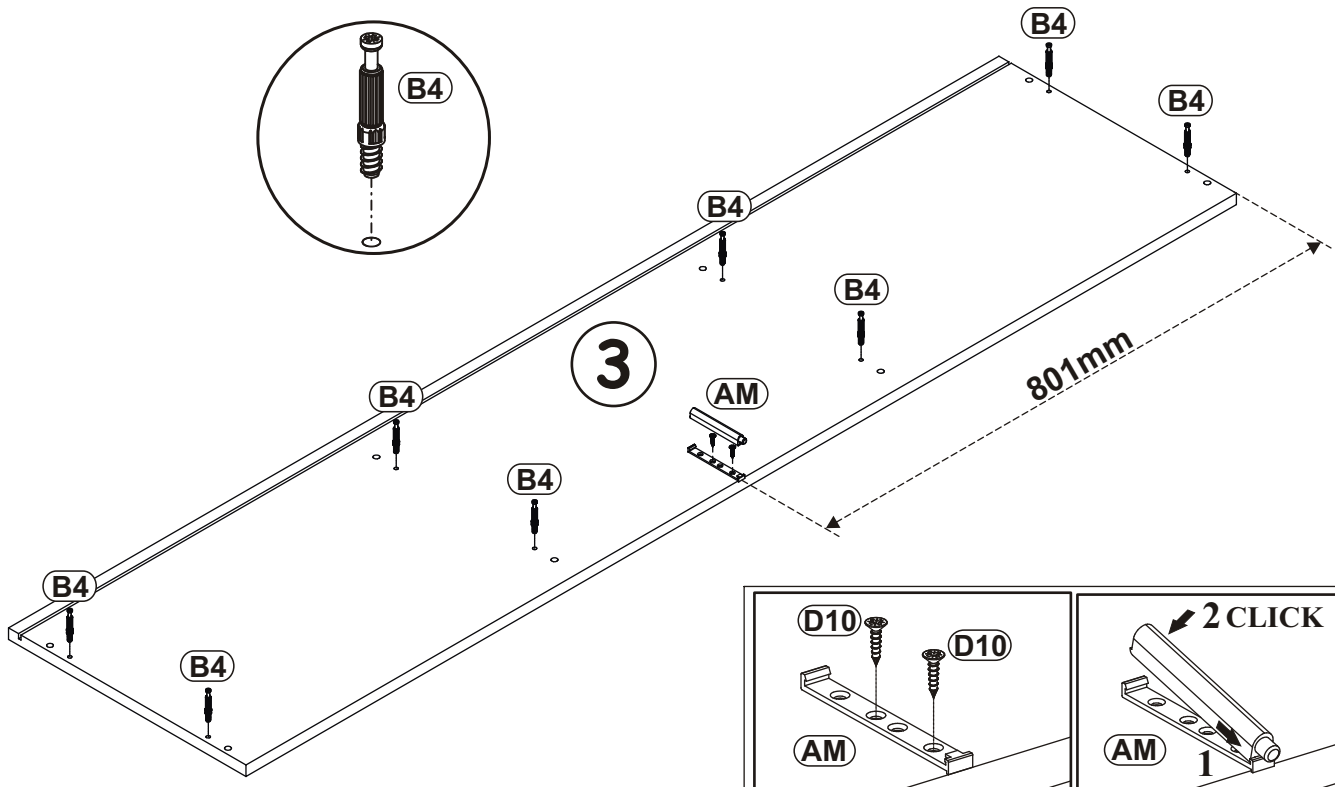

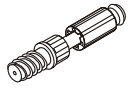
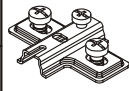

2

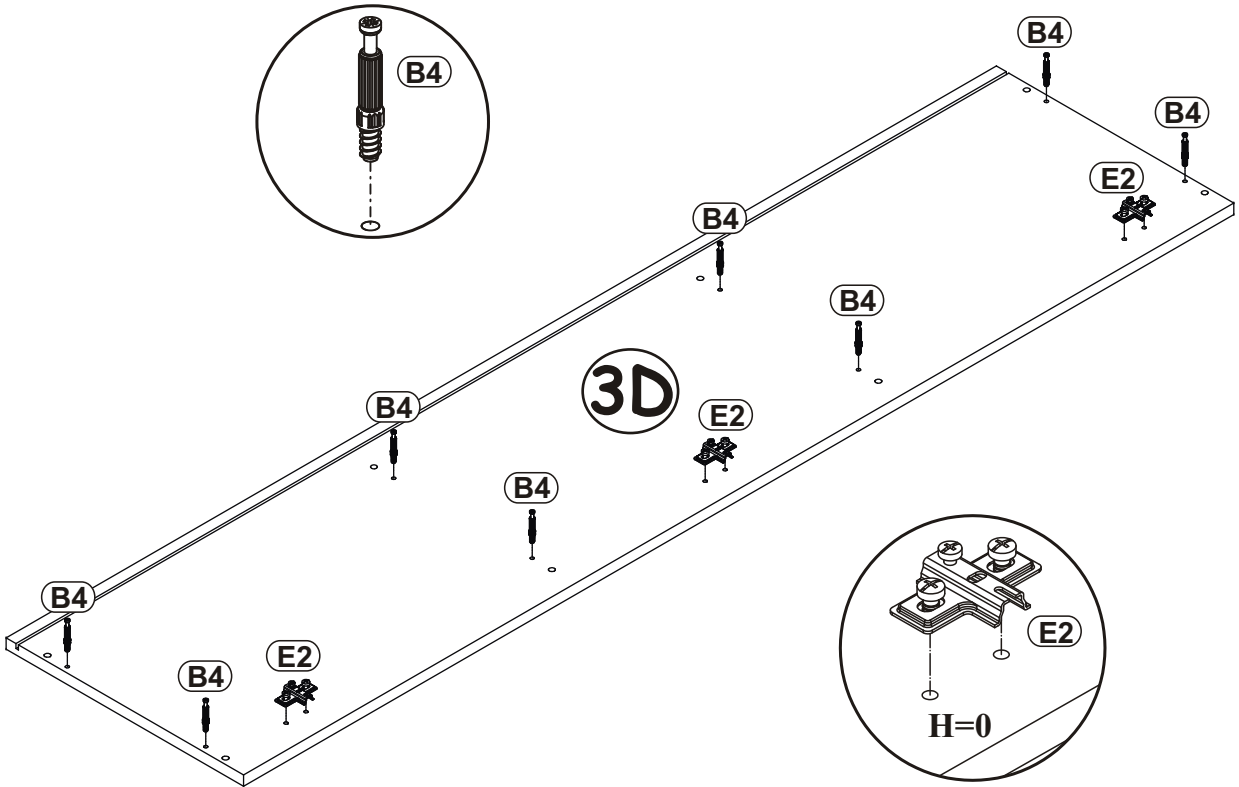
B4		E2	
x8		x3	H=0



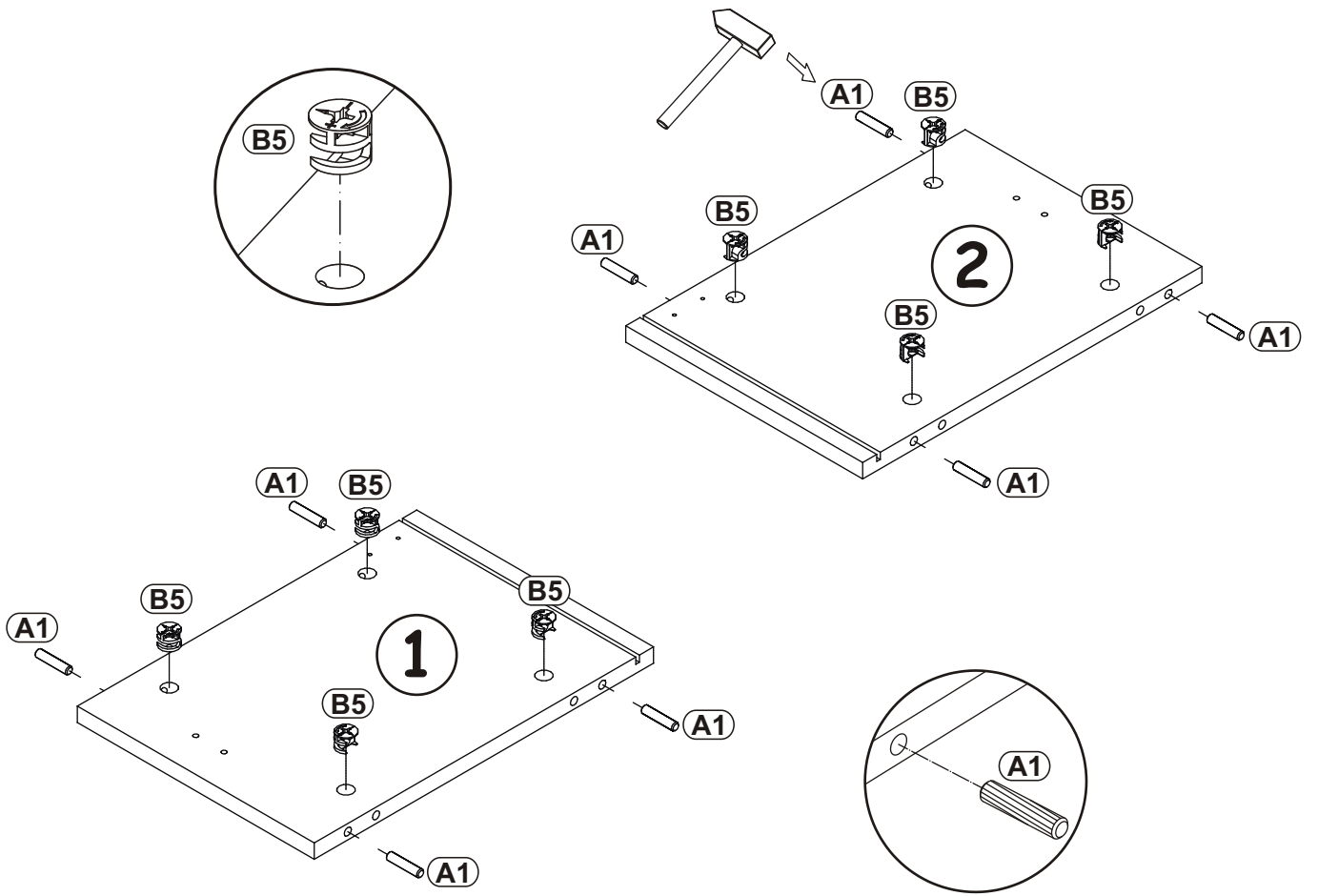

3

A1	 ø8x36	B5	 ø15x12
x8		x8	



4

A1	 ø8x36	B5	 ø15x12
x8		x8	

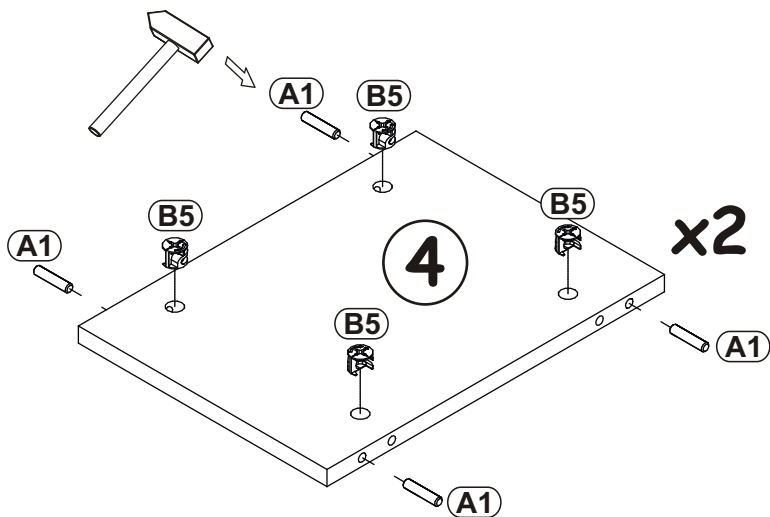

5

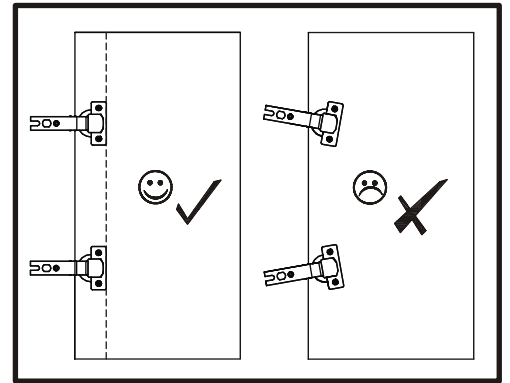
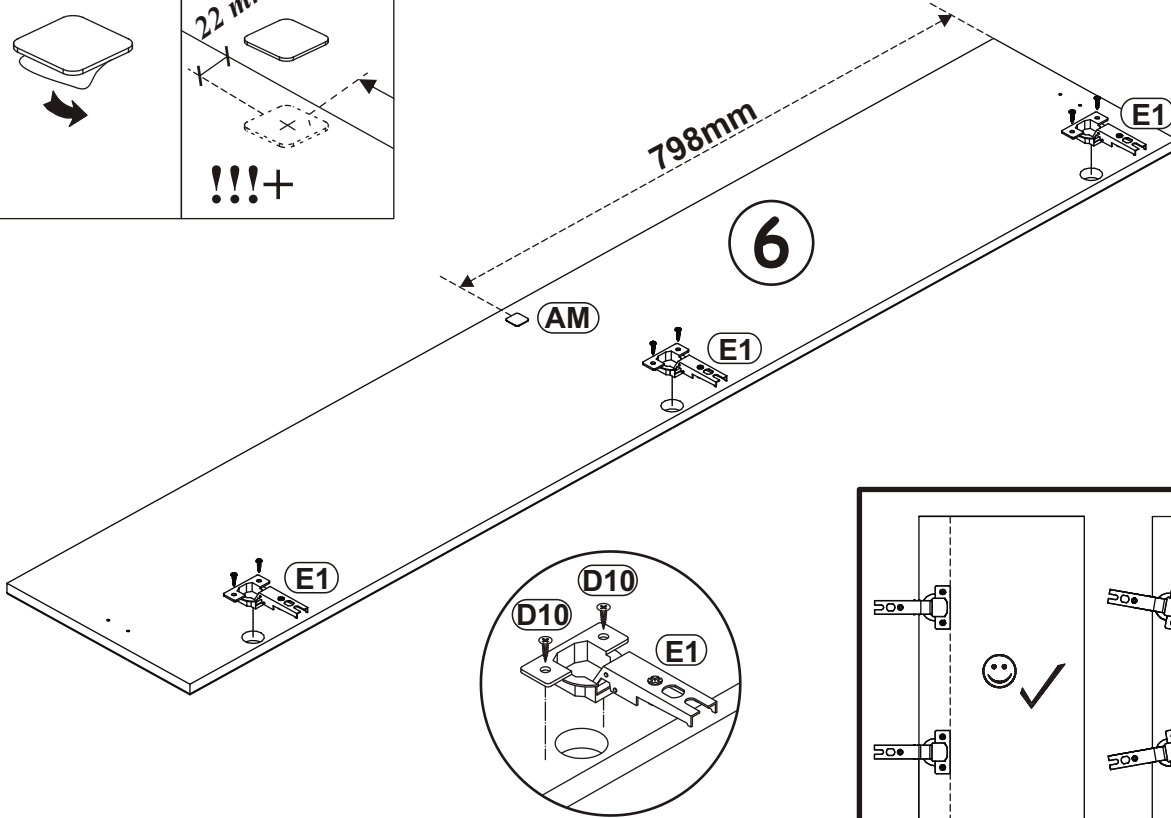
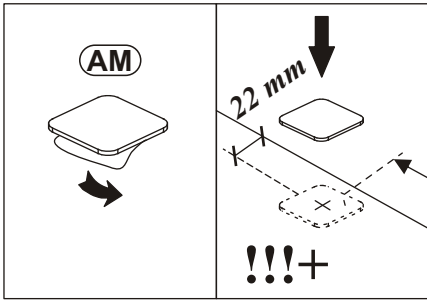
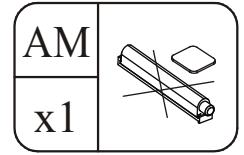
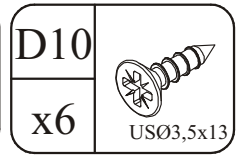
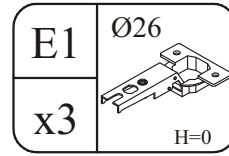
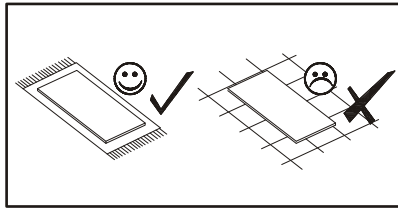

6

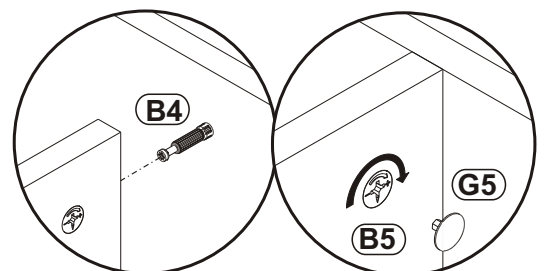
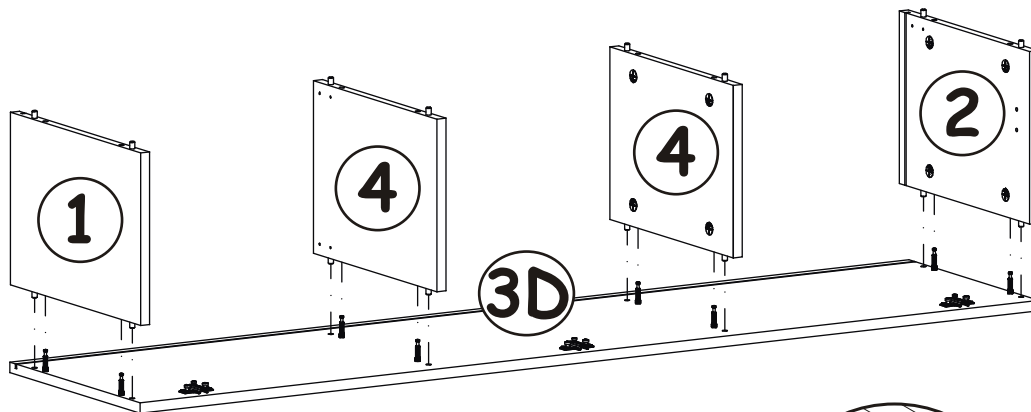
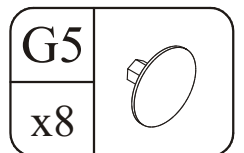

7

G5	
x8	

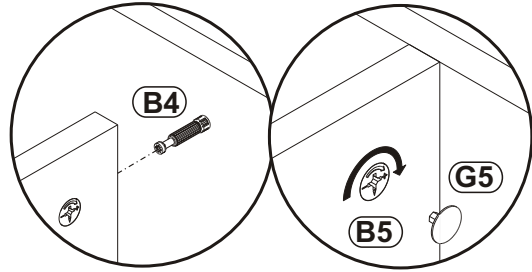
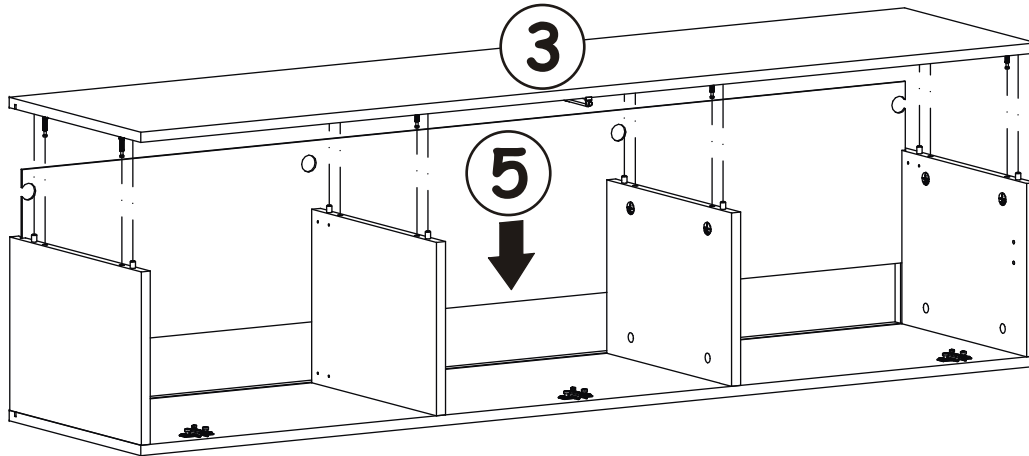



8

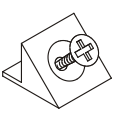

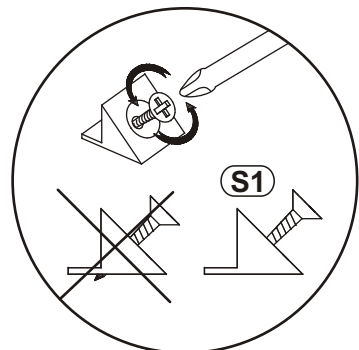
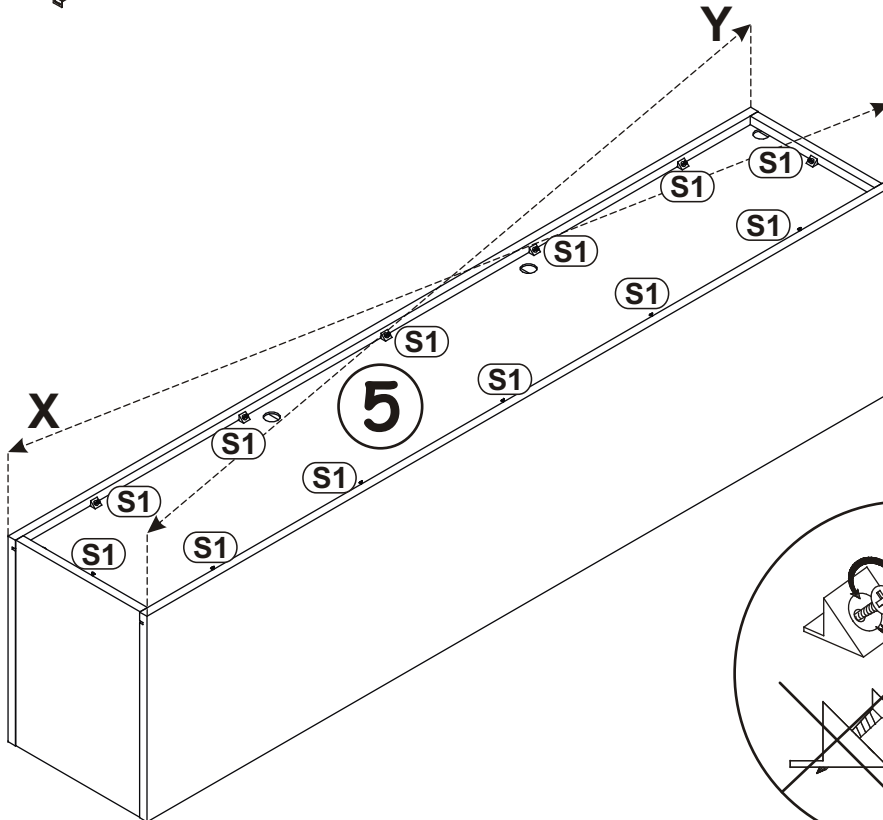
S1	
x12	

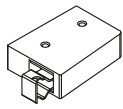

9

ZR1		D6	
x4		x8	USØ3,5x30

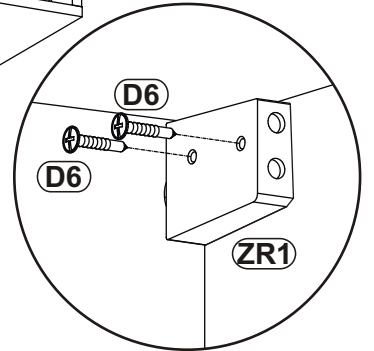
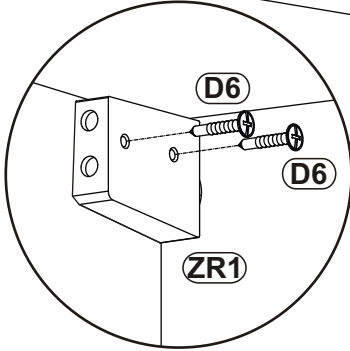
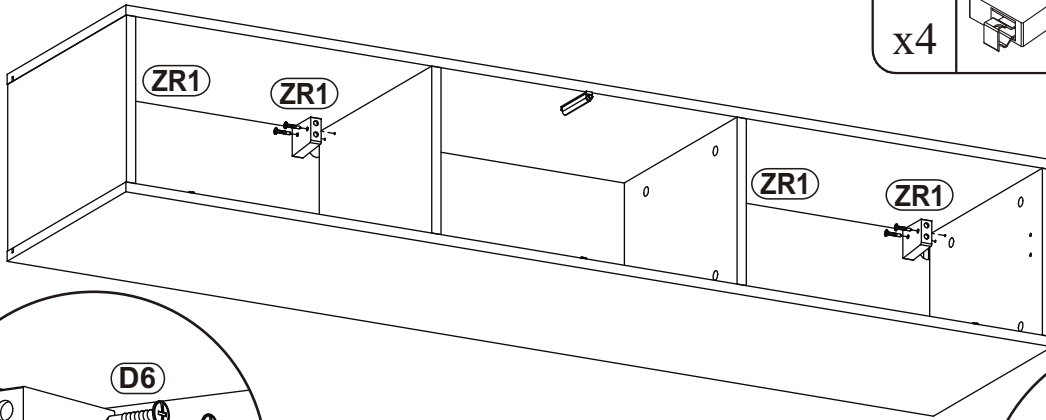

10

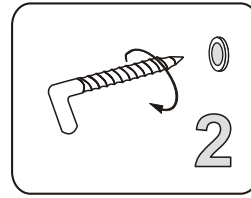
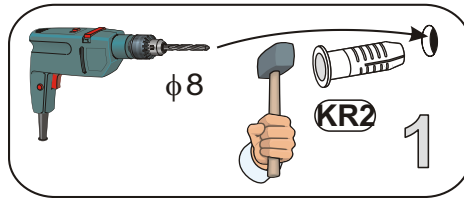
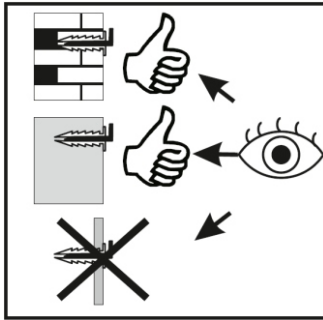

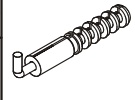
KR2	
x4	

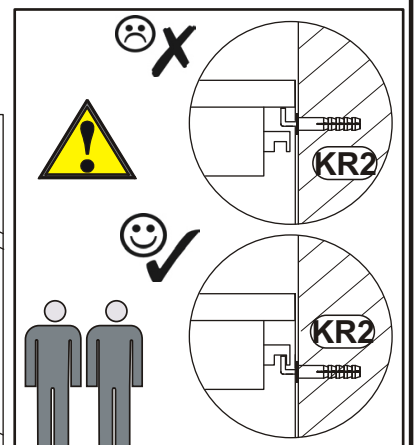
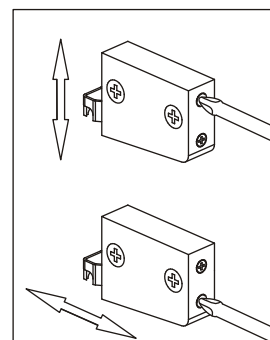
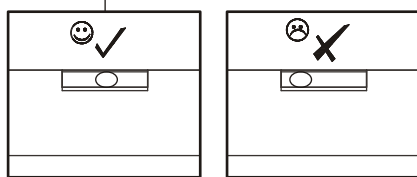
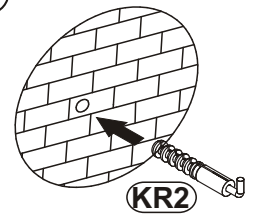
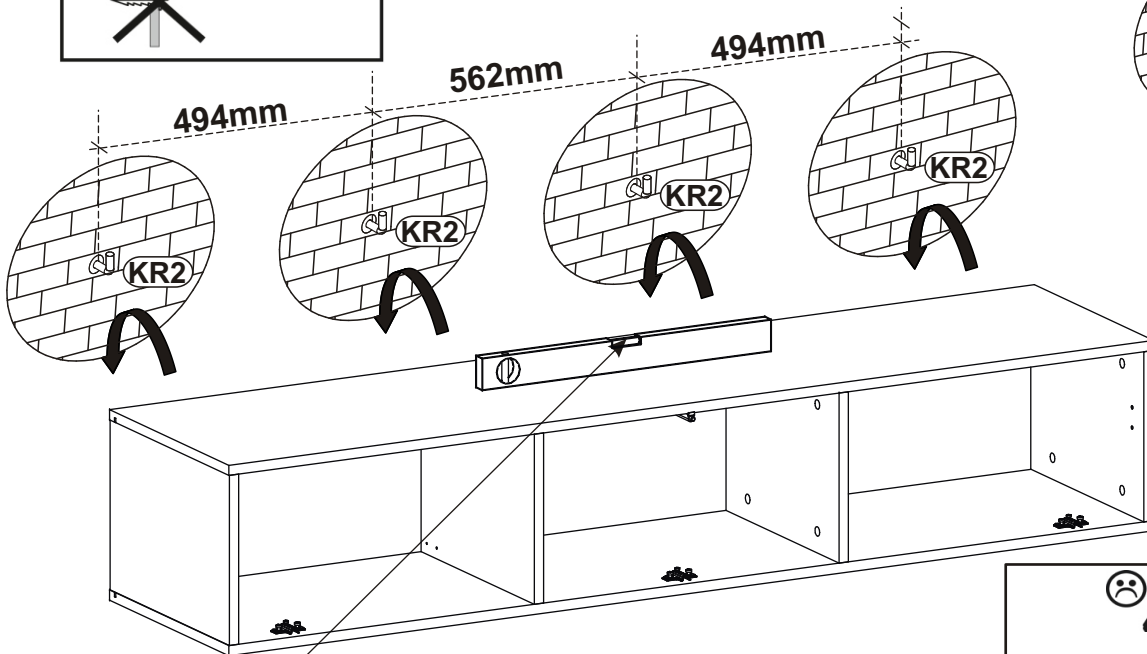

11

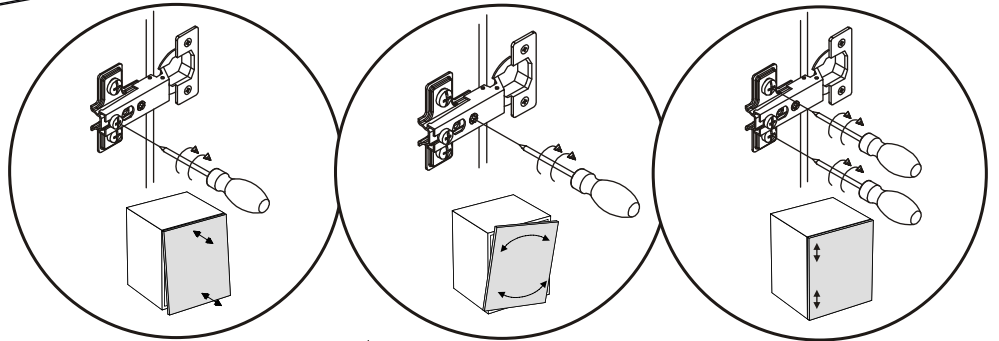
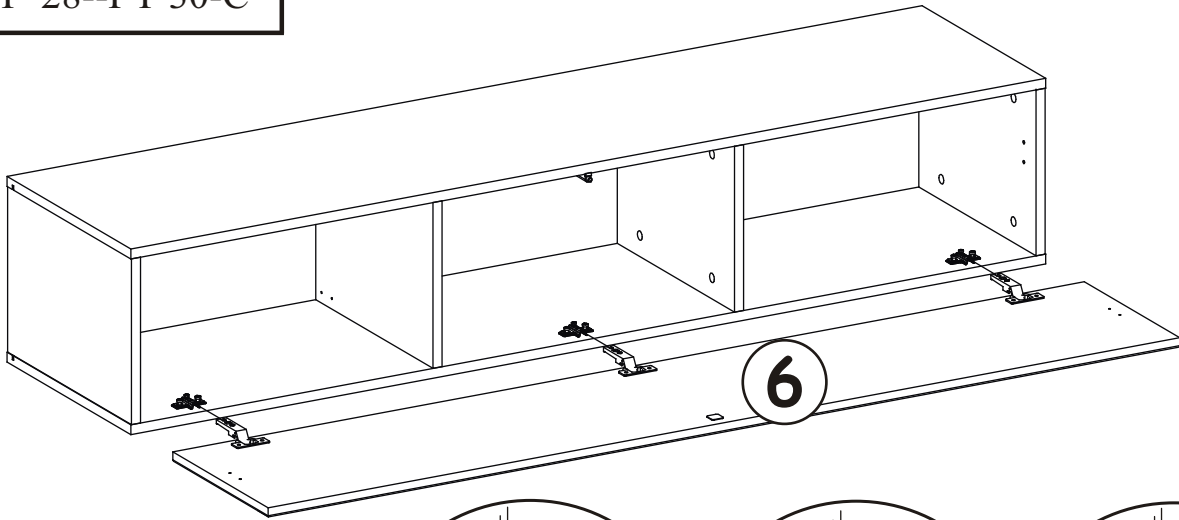

12

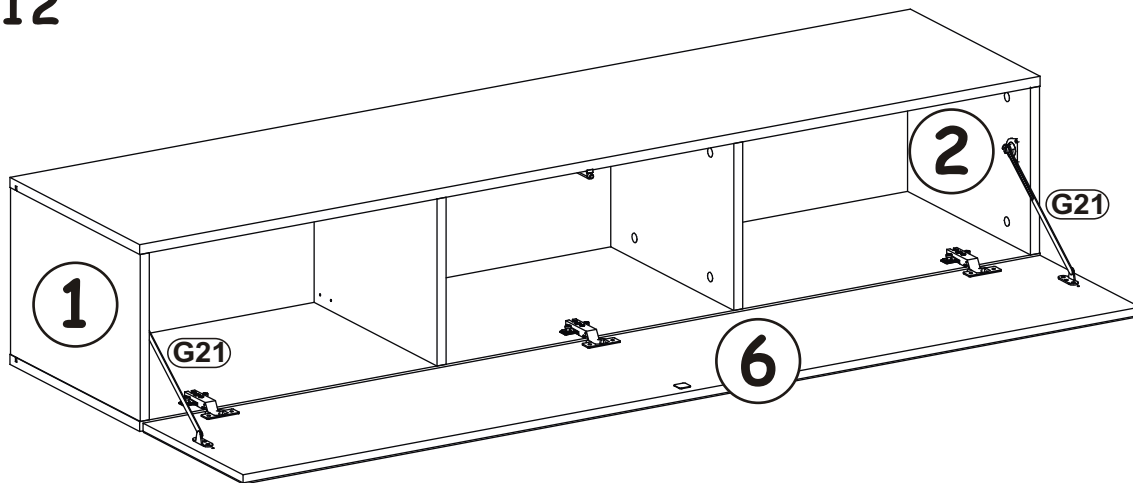

- | | |
|-----|-----------|
| G21 | |
| x2 | |
| D7 | |
| x6 | USØ3x16 |
| D10 | |
| x6 | USØ3,5x13 |

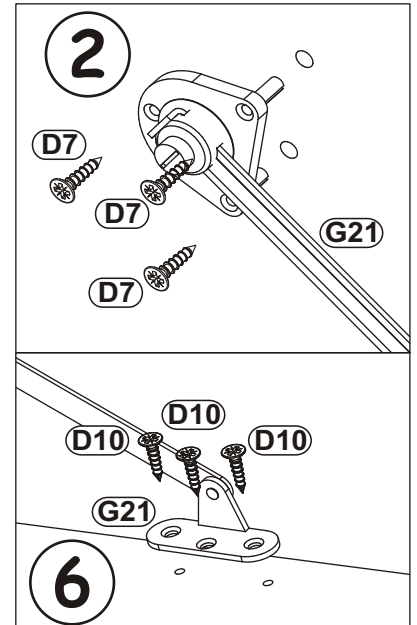
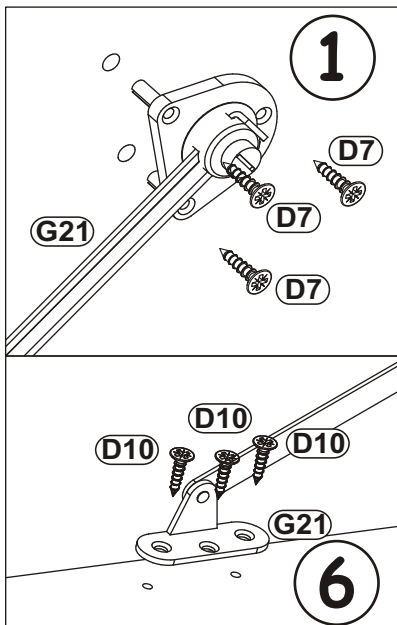



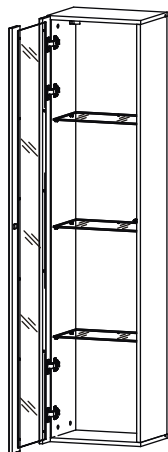
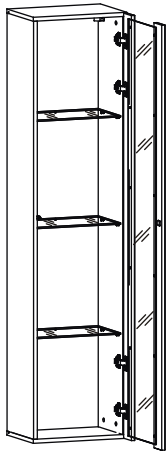
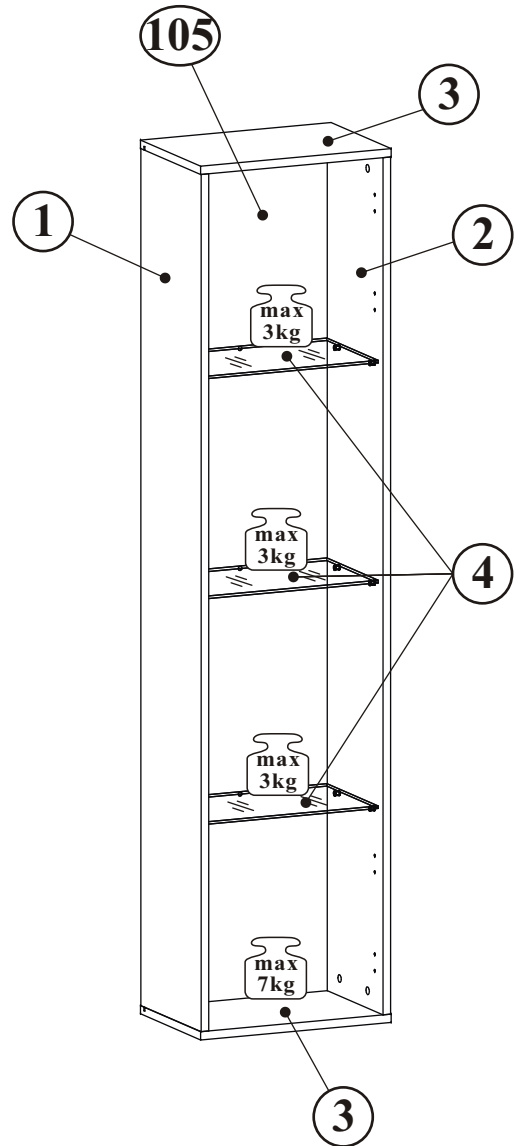
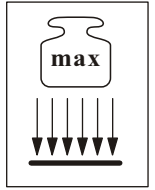
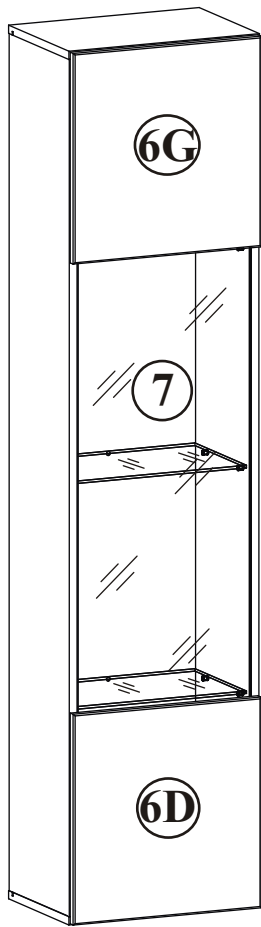



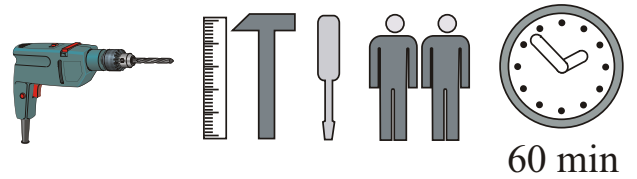



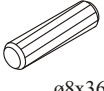
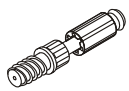

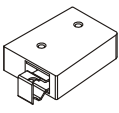
FLY 28 -- FY 42-C

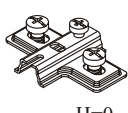
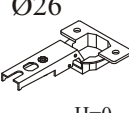

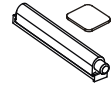
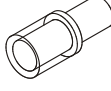
NO	Dim.		Col.-No	Qty
1	1668	274	1	1
2	1668	274	1	1
3	400	274	1	2
4	364	234	1	3
105	1680	378	1	1
6G	394	410	1	1
6D	394	410	1	1
7	925	362	1	1

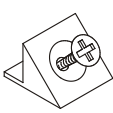
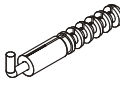

FLY 28--FY 42-C

A1 x8  ø8x36	B4 x8 	B5 x8  ø15x12	G5 x8 	ZR1 x2 	D6 x4  USØ3,5x30
E2 x4  H=0	E1 x4  Ø26 H=0	D10 x10  USØ3,5x13	AM x1 	G20 x12 	Z2 x8  Ø5
P2 x6 	UP13 x6  UPØ3x16	S1 x12 	KR2 x2 	G2 x1 	

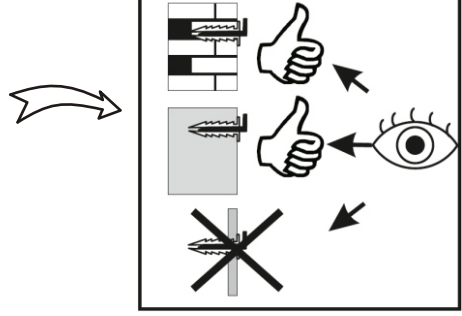
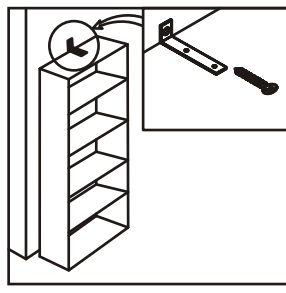
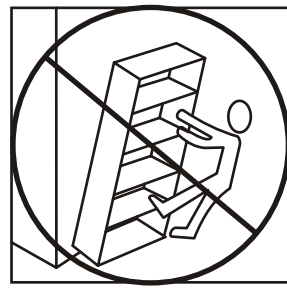
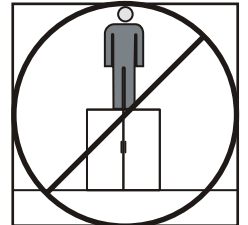
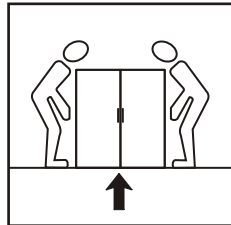
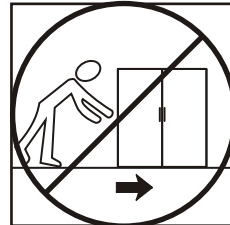
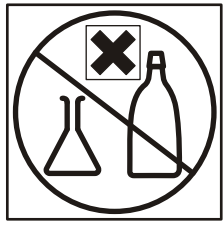
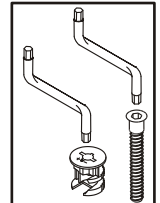
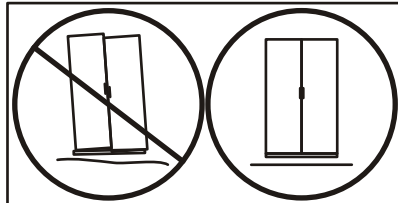
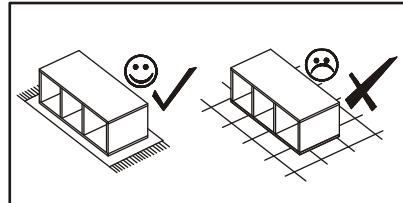
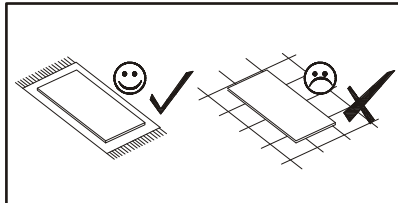
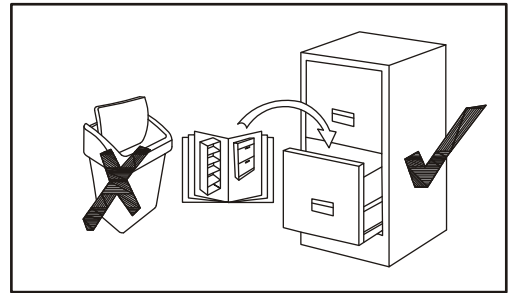
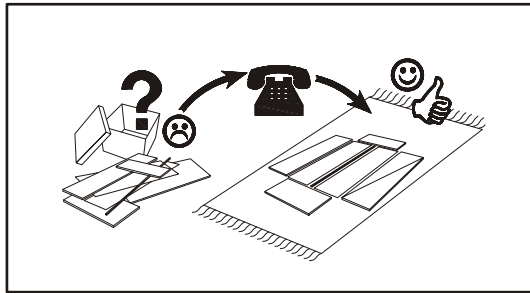
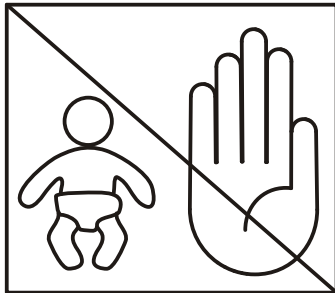
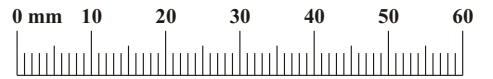

FLY 28--FY 42-C

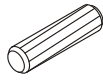
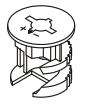
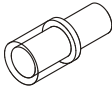
A1		B5		G20	
x8	ø8x36	x8	ø15x12	x12	

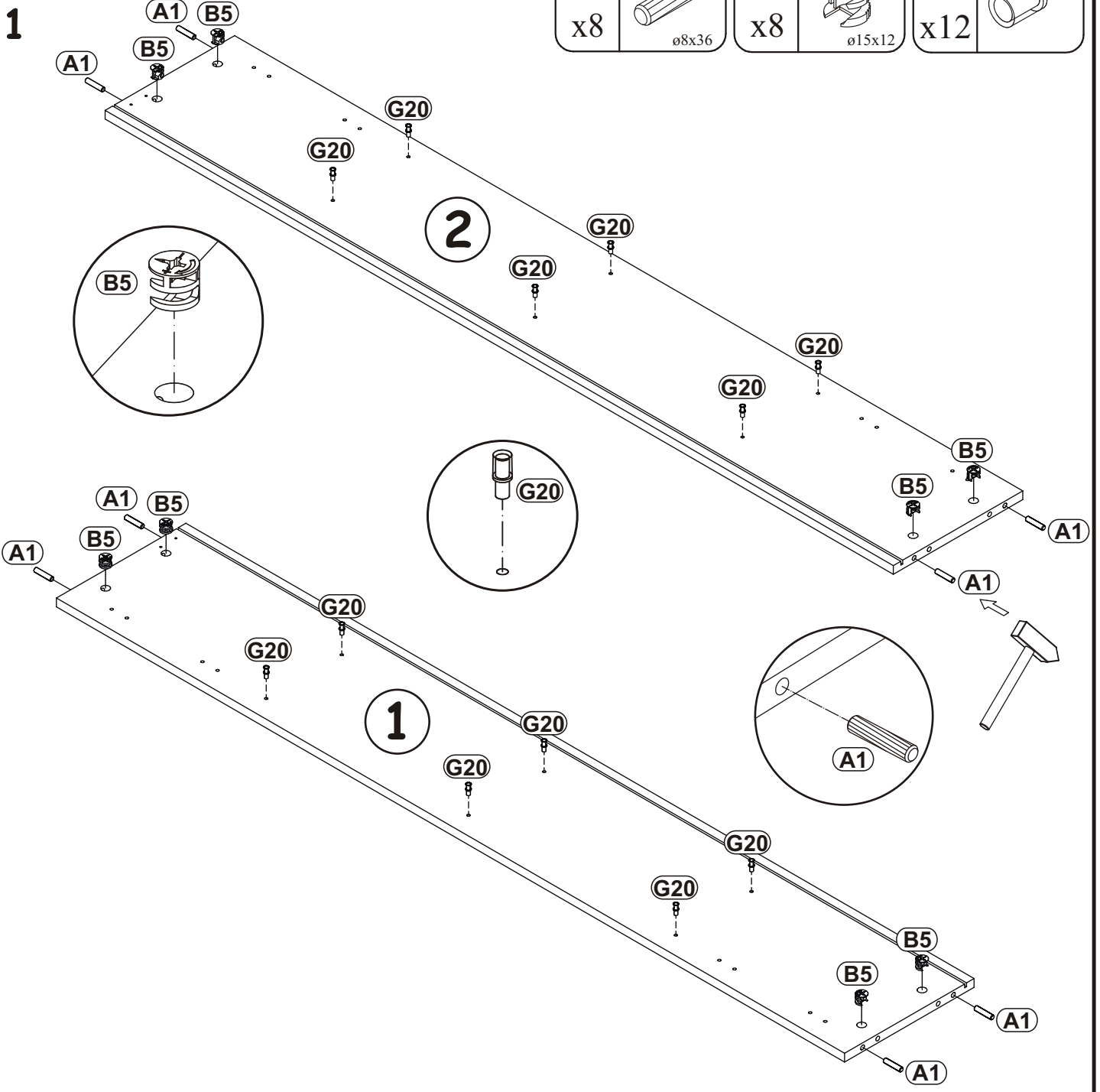

2

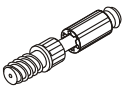
B4	
x8	

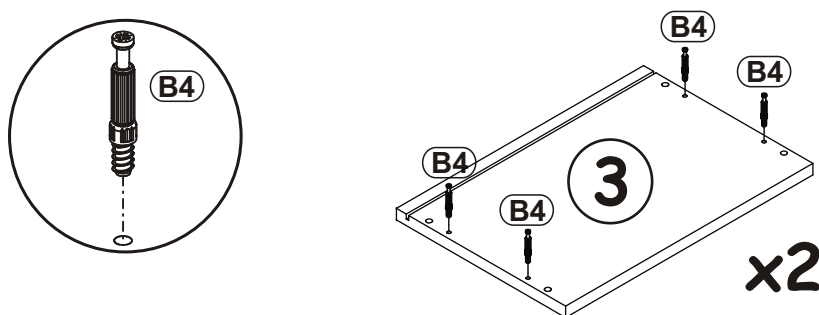

FLY 28--FY 42-C

3

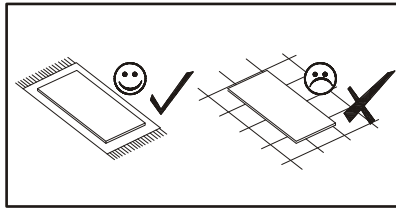

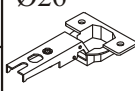
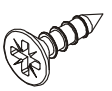
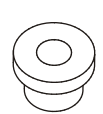
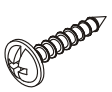

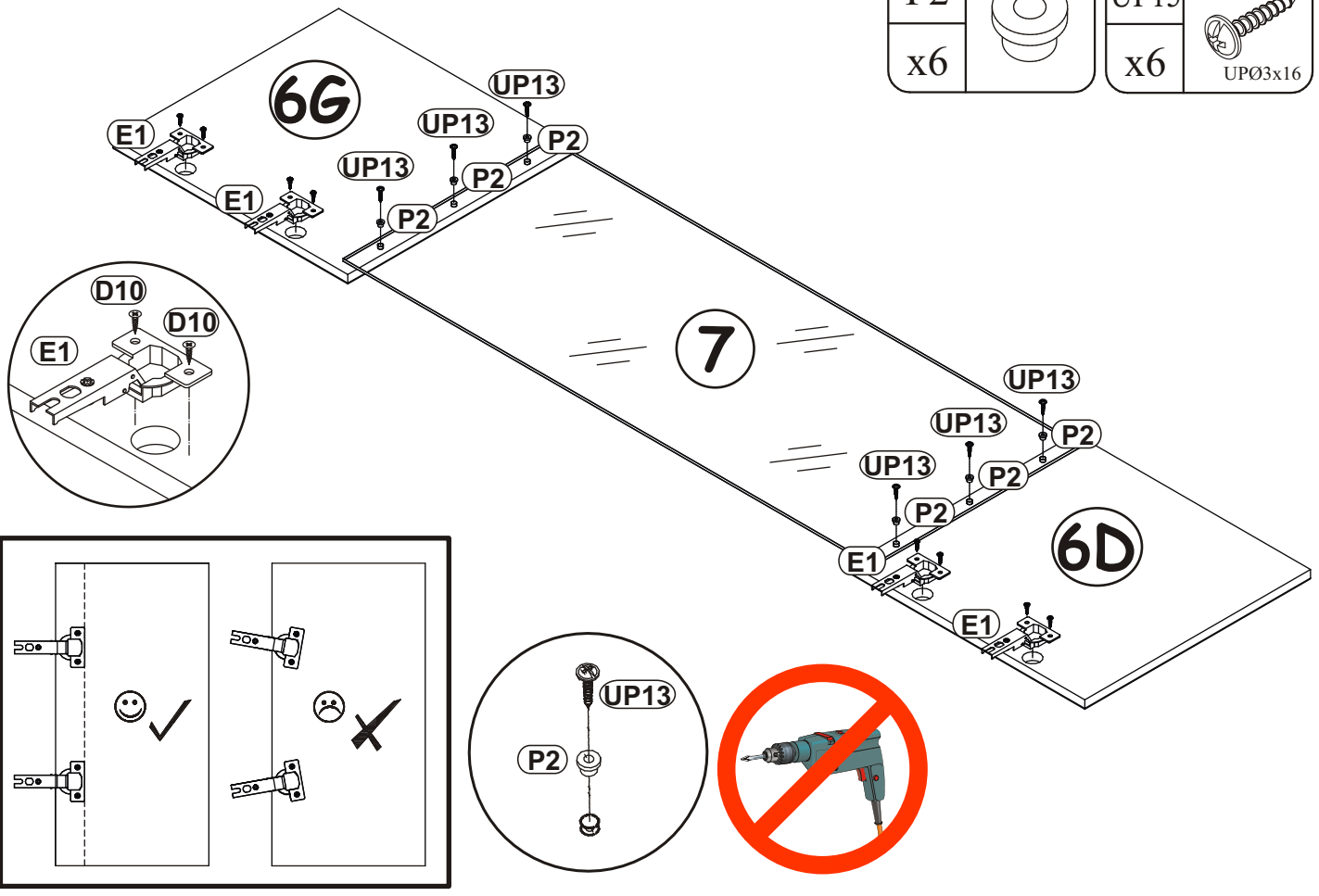
E1	Ø26	D10	
x4	 H=0	x8	 USØ3,5x13
P2		UP13	
x6		x6	 UPØ3x16

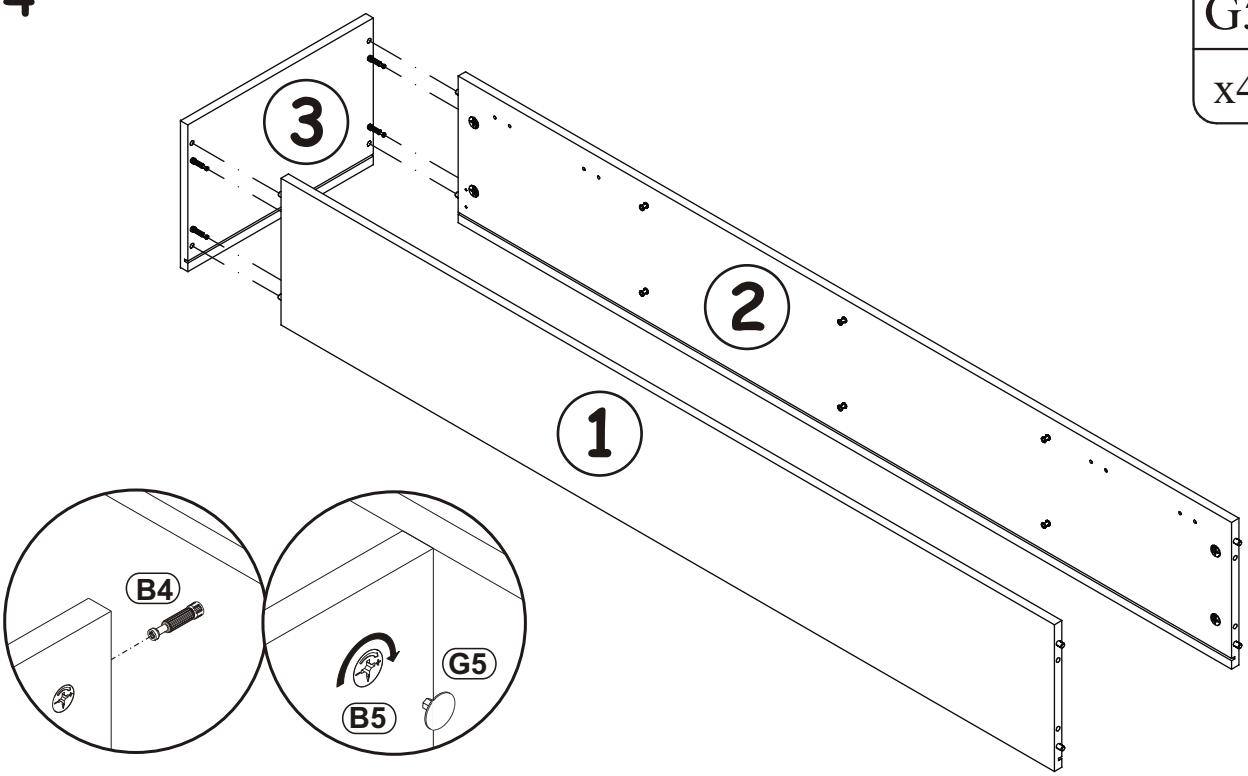

4

G5	
x4	



G5	
x4	

5

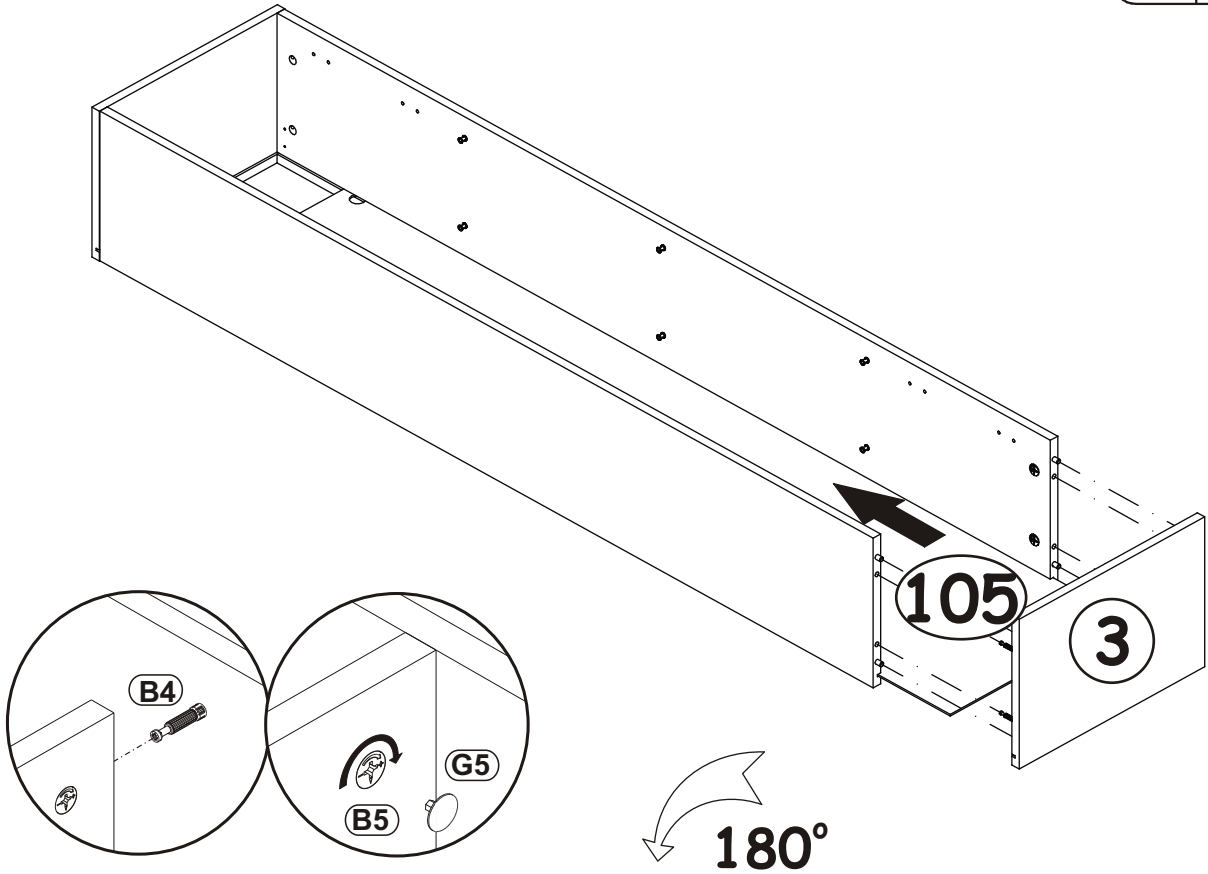

6

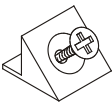

S1	
x12	

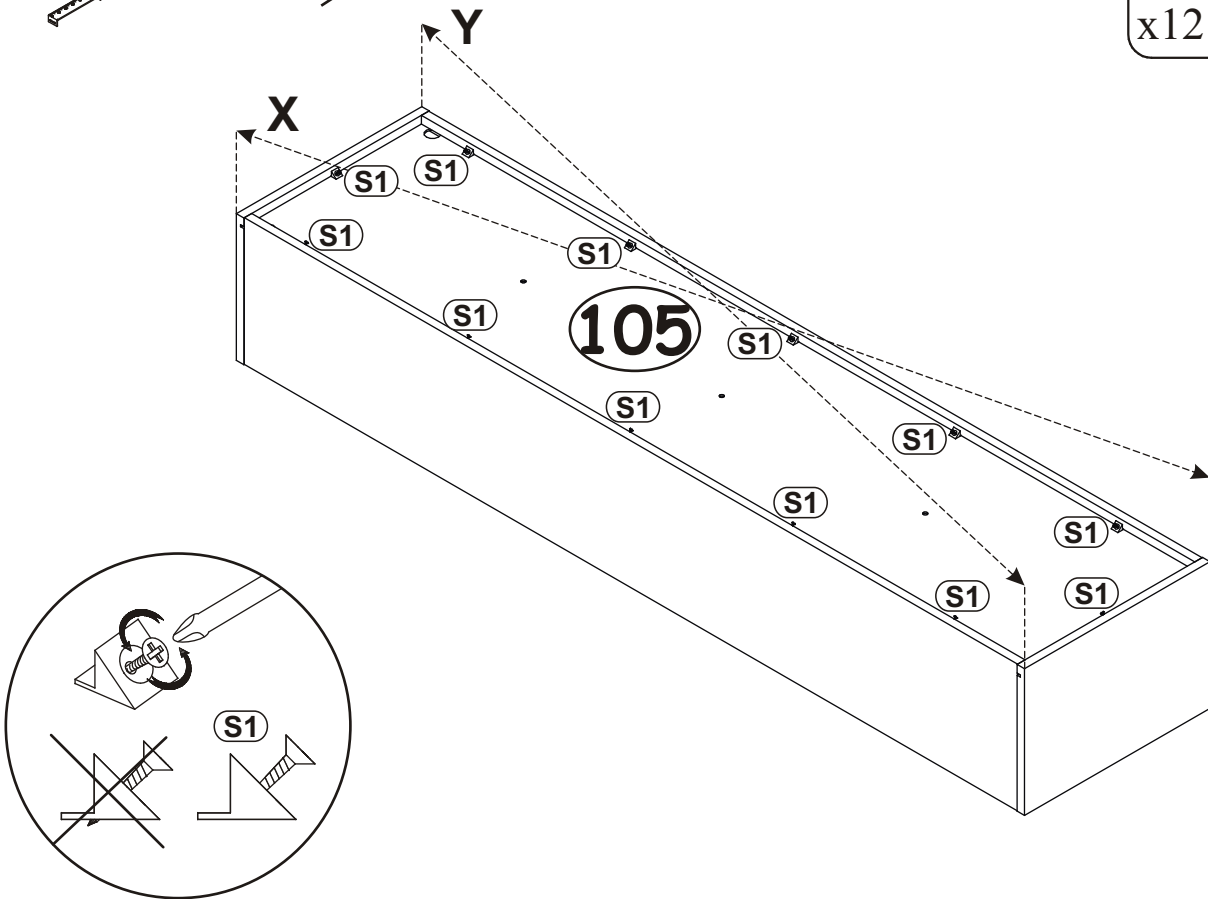

7

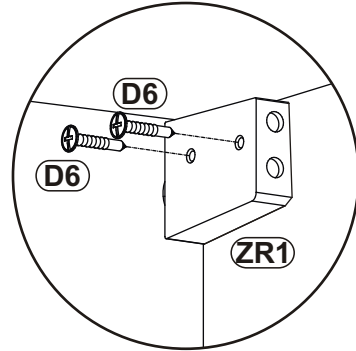
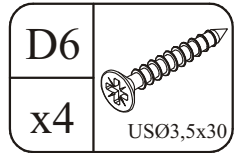
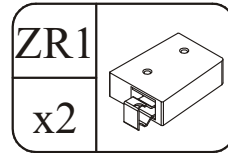
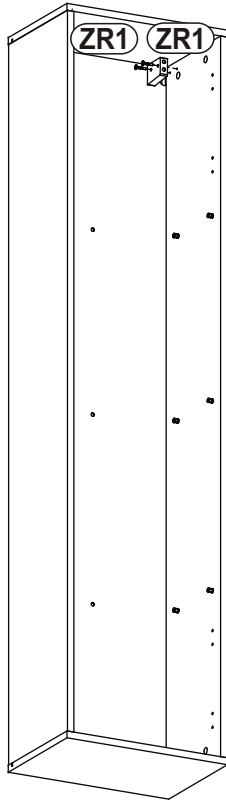
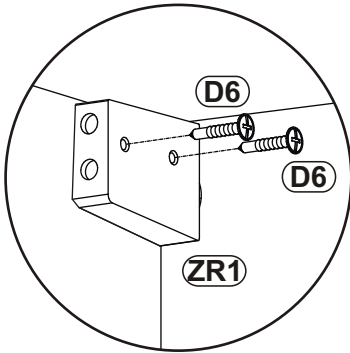

8

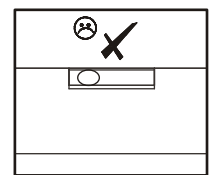
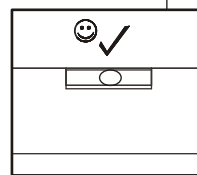
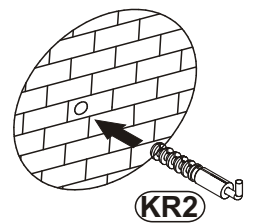
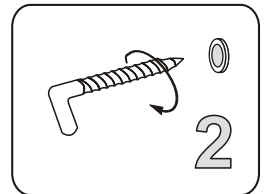
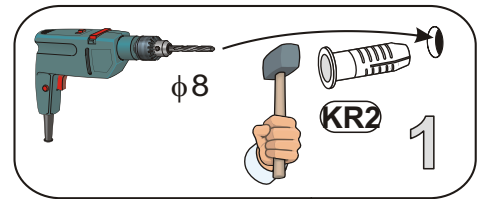
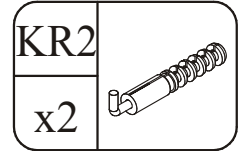
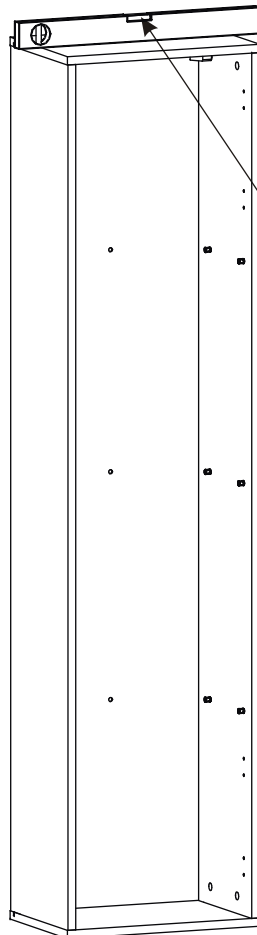
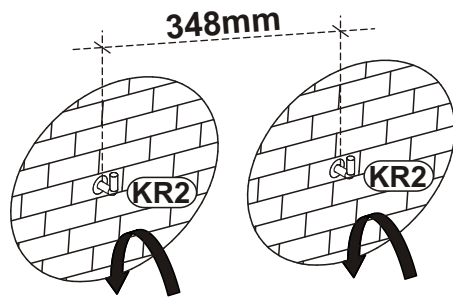
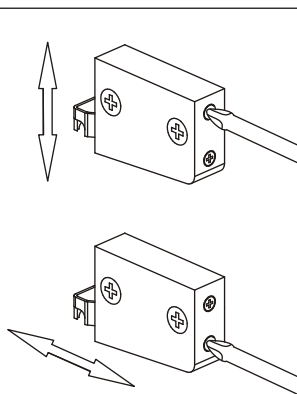
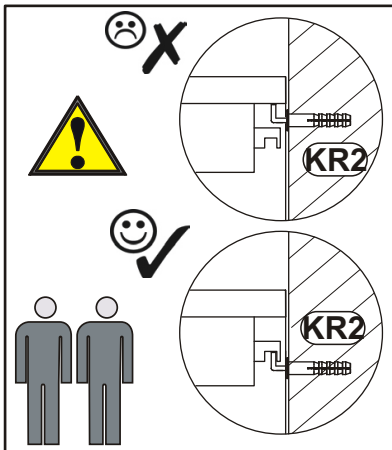
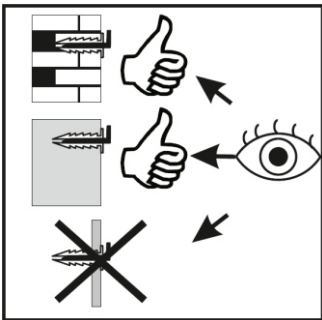

9-10

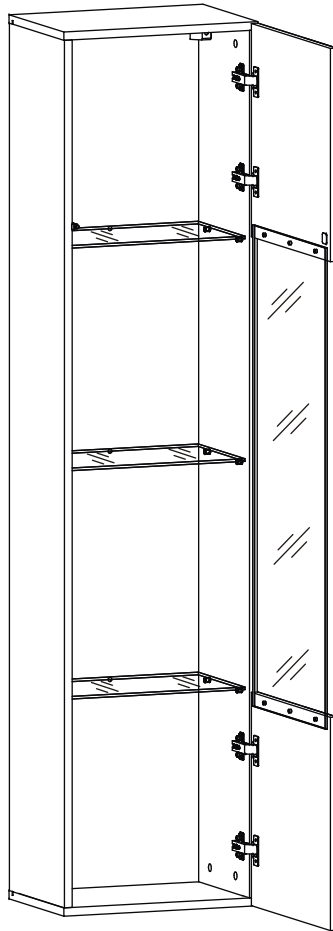

11-12

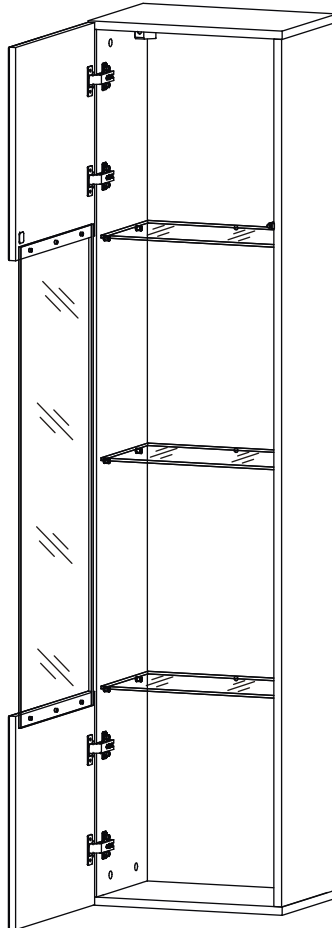

9

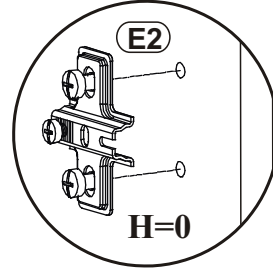
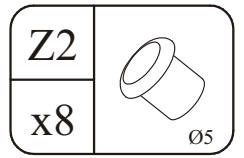
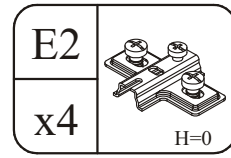
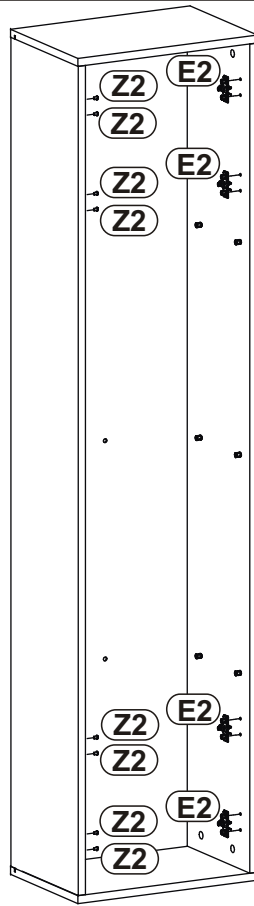
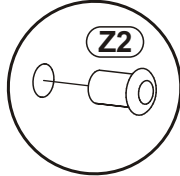
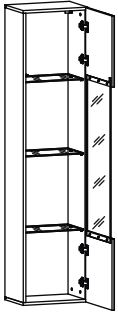

10

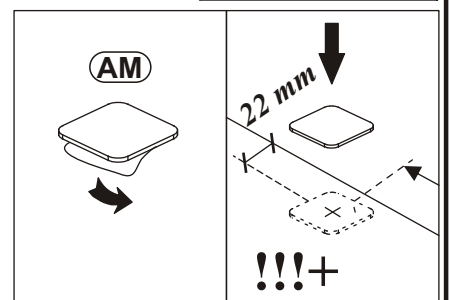
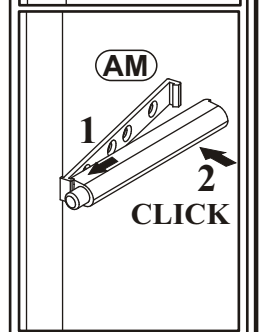
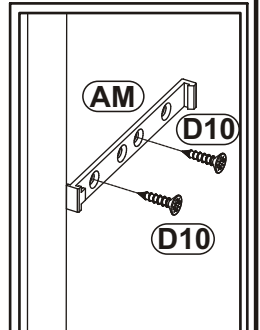
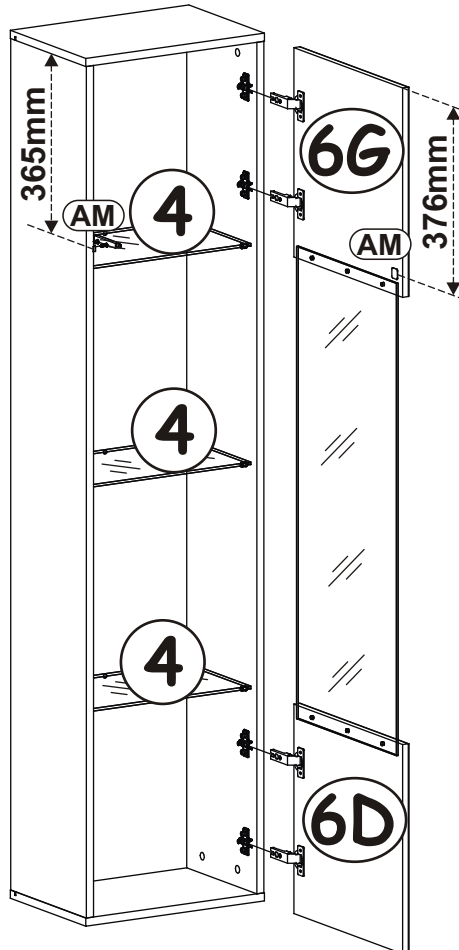
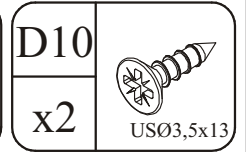
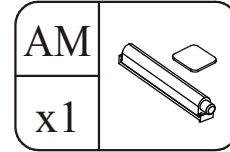
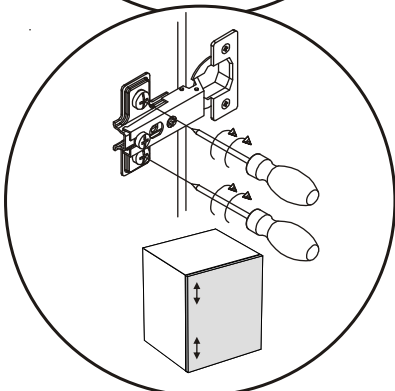
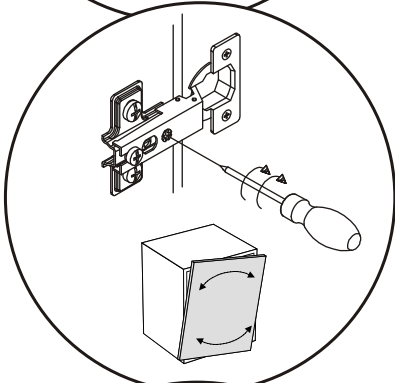
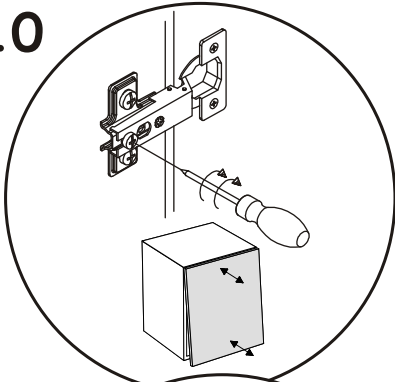

11

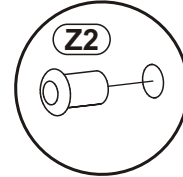
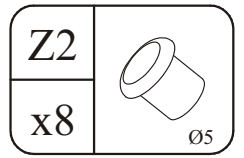
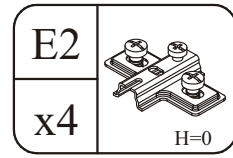
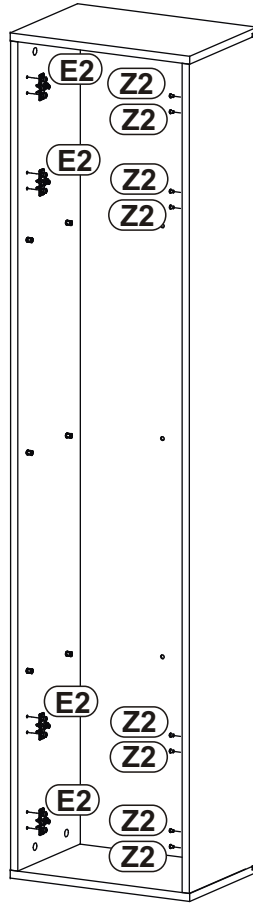
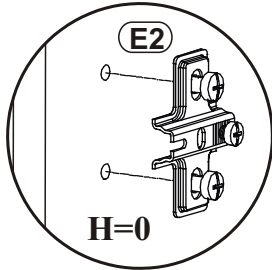
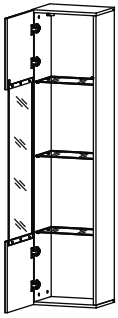

12

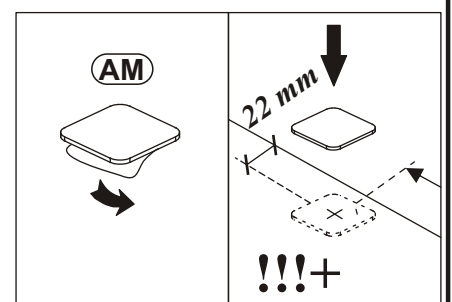
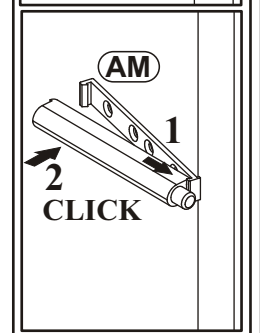
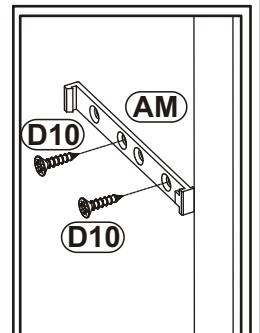
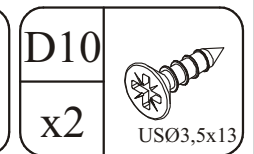
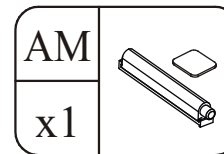
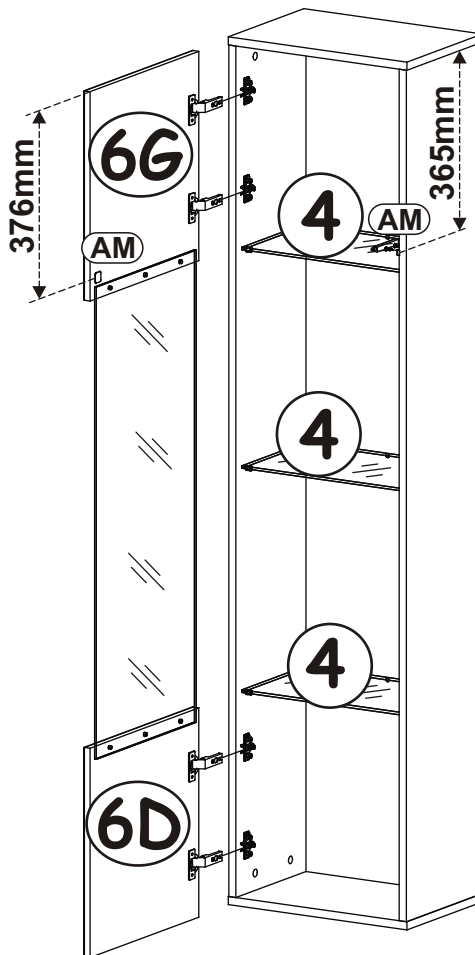
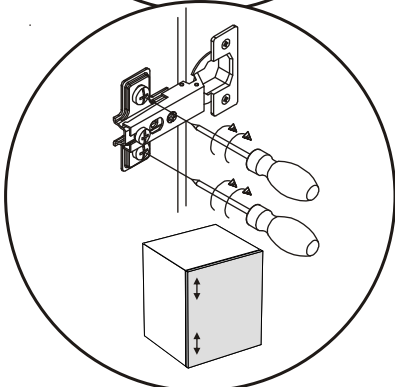
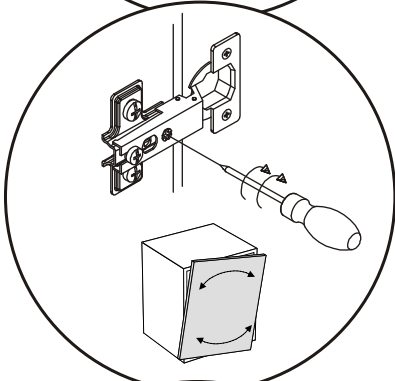
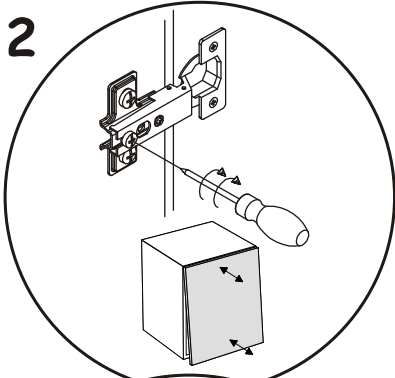



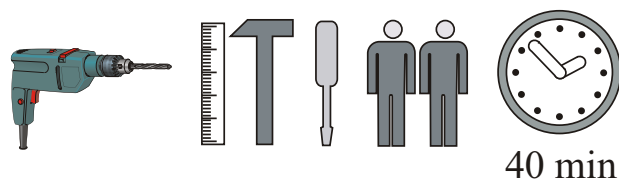
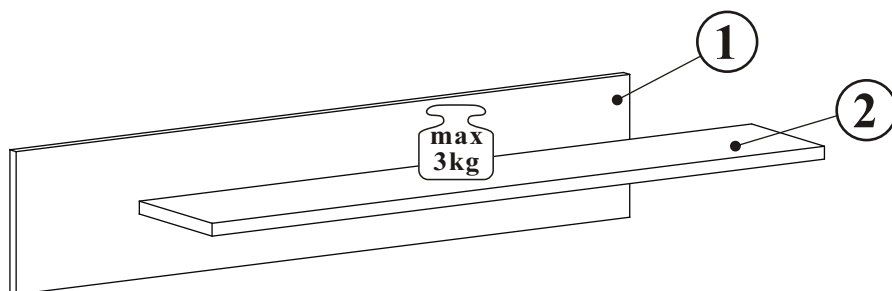
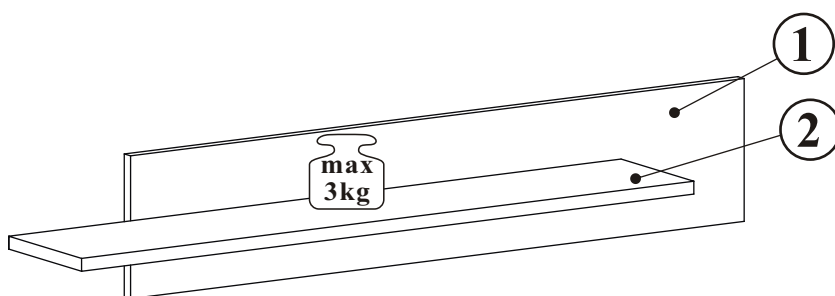
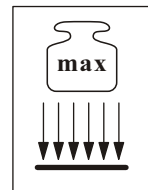
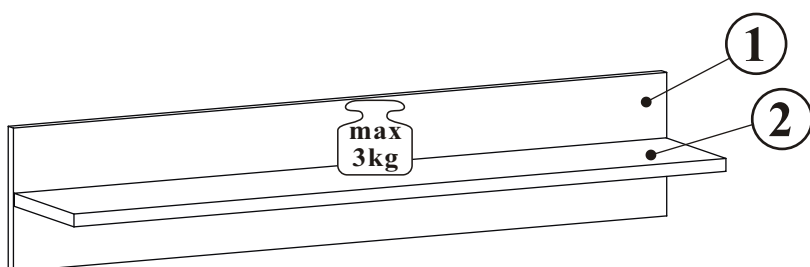



GALINO 23_MX

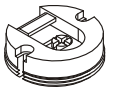

NO	Dim.		Col.-No	Qty
1	1002	200	1	2
2	1000	185	1	2

GALINO 23_MX

ZM1 x4		D20 x8	 ESØ6x9,5	B11 x12	 Ø7x50	G4 x12		KR2 x4		G2 x1	
-----------	---	-----------	---	------------	--	-----------	---	-----------	---	----------	---

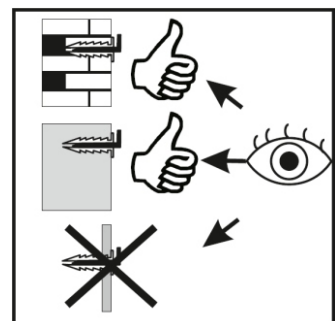
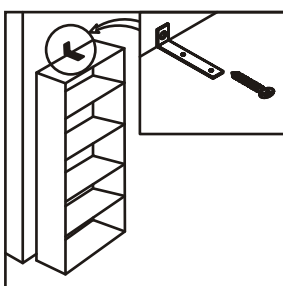
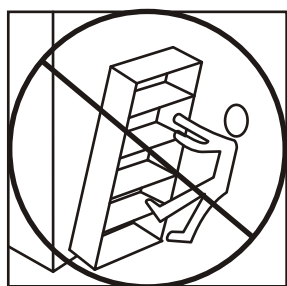
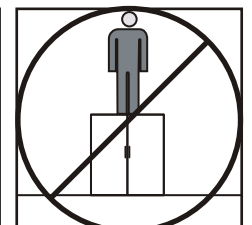
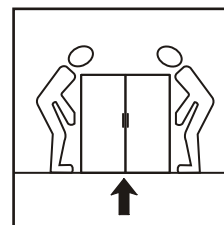
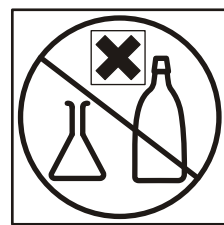
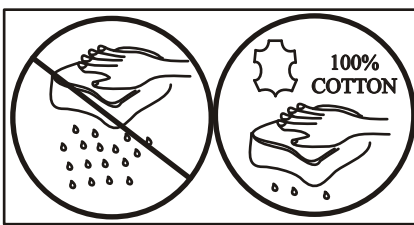
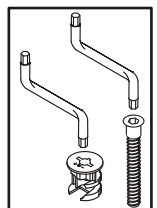
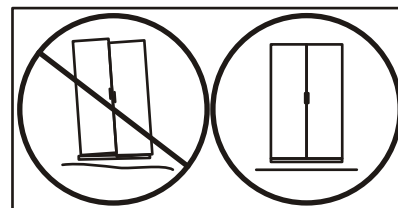
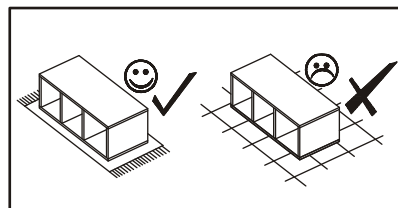
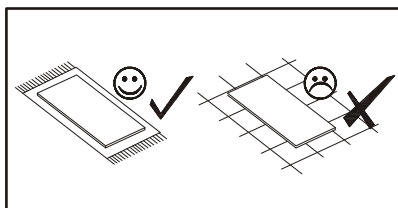
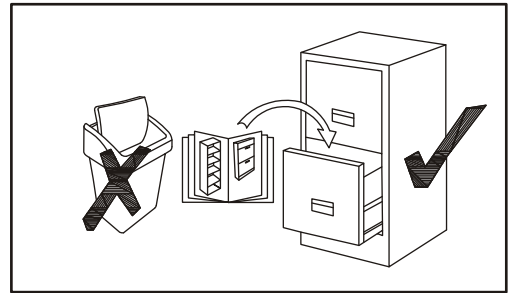
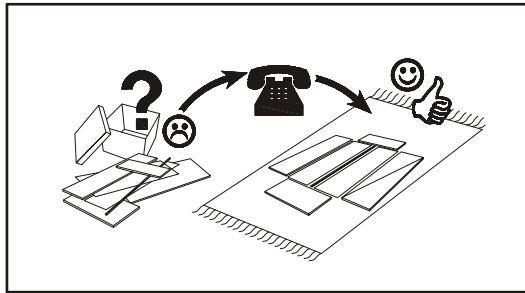
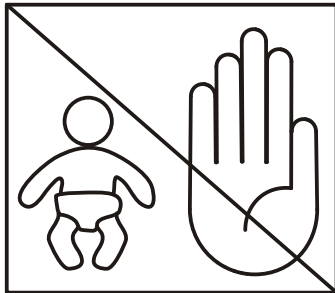
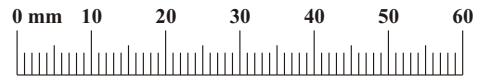

1-3

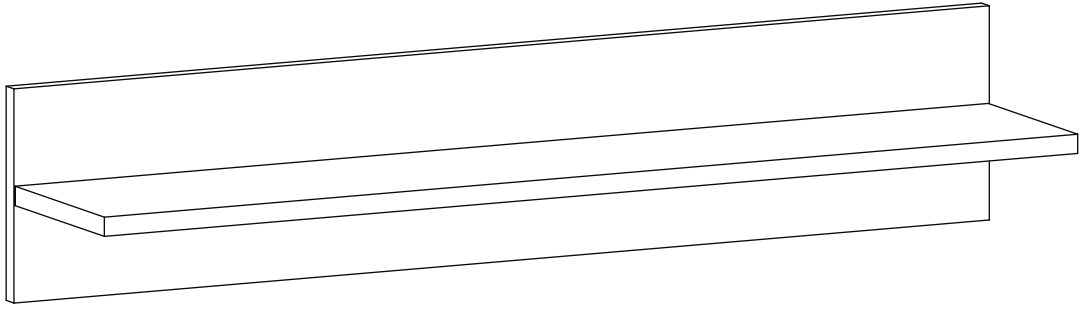

4-6

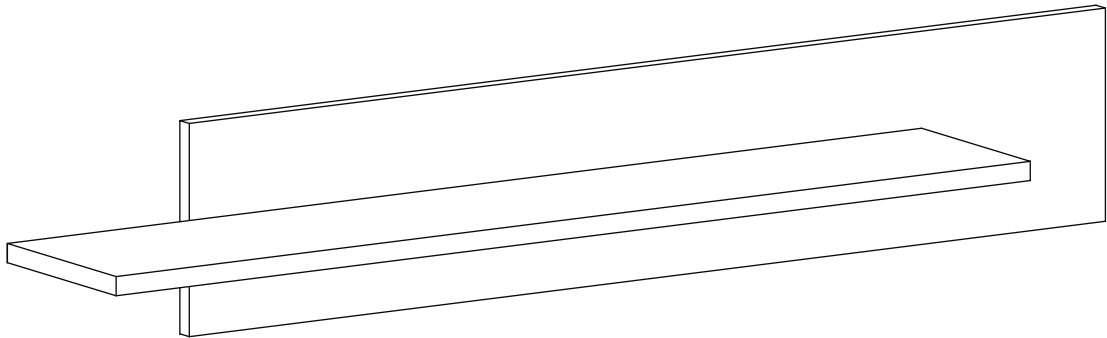

7-9

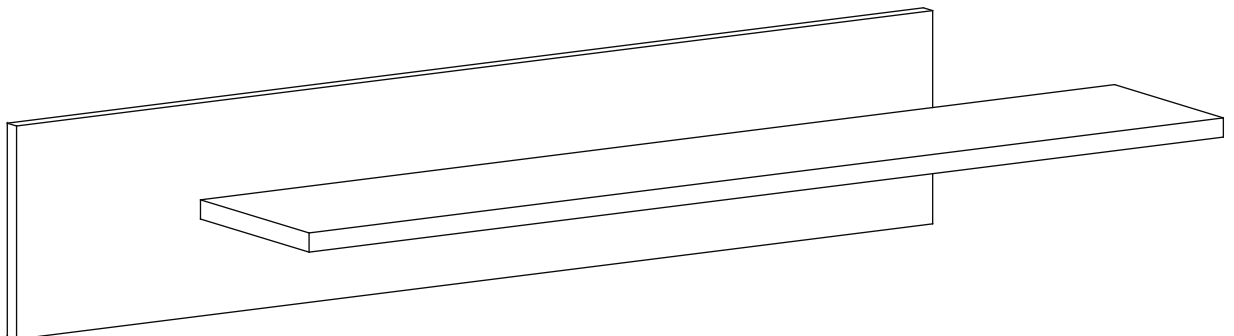

GALINO 23_MX

1

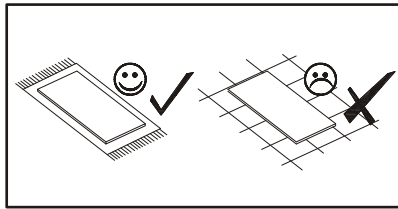

ZM1
x4

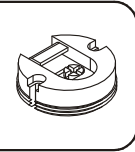

D20
x8

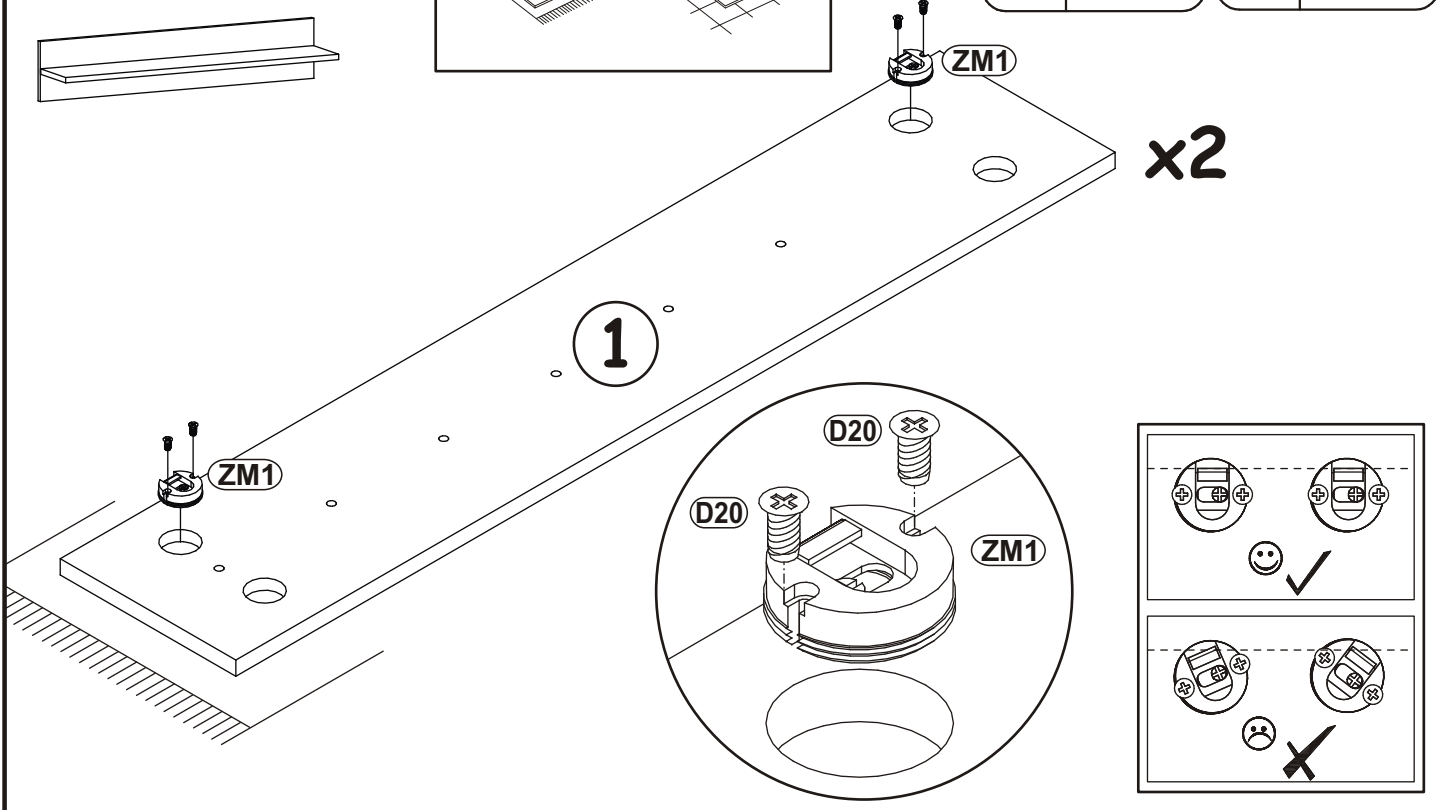
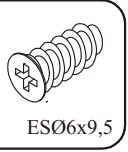

2

B11
x12

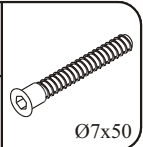

G4
x12

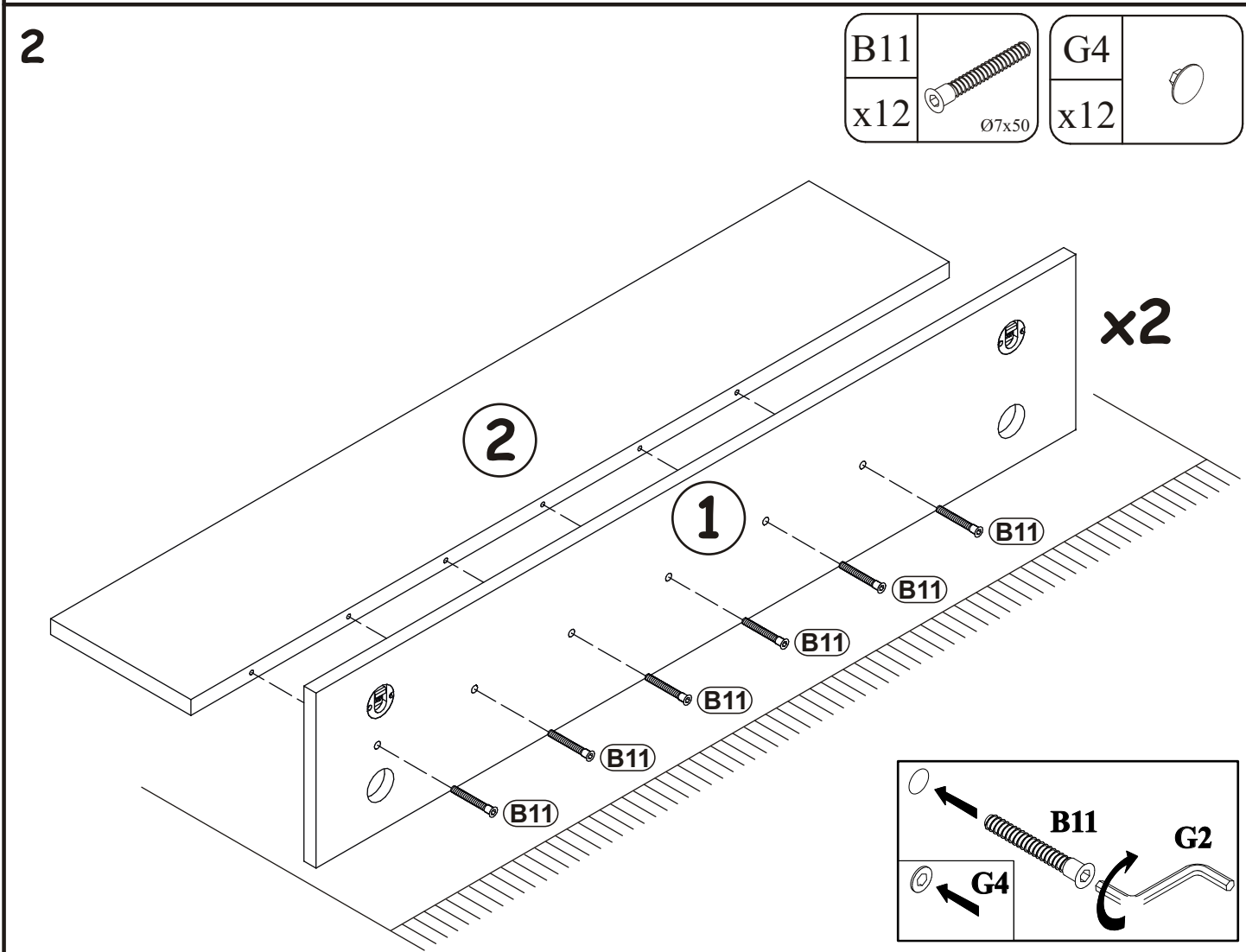
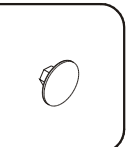

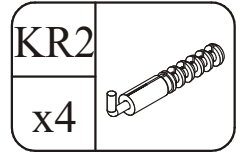

3

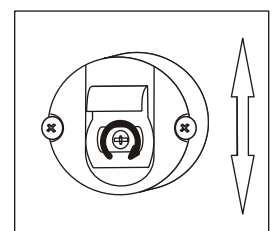
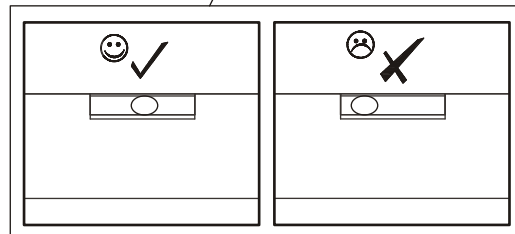
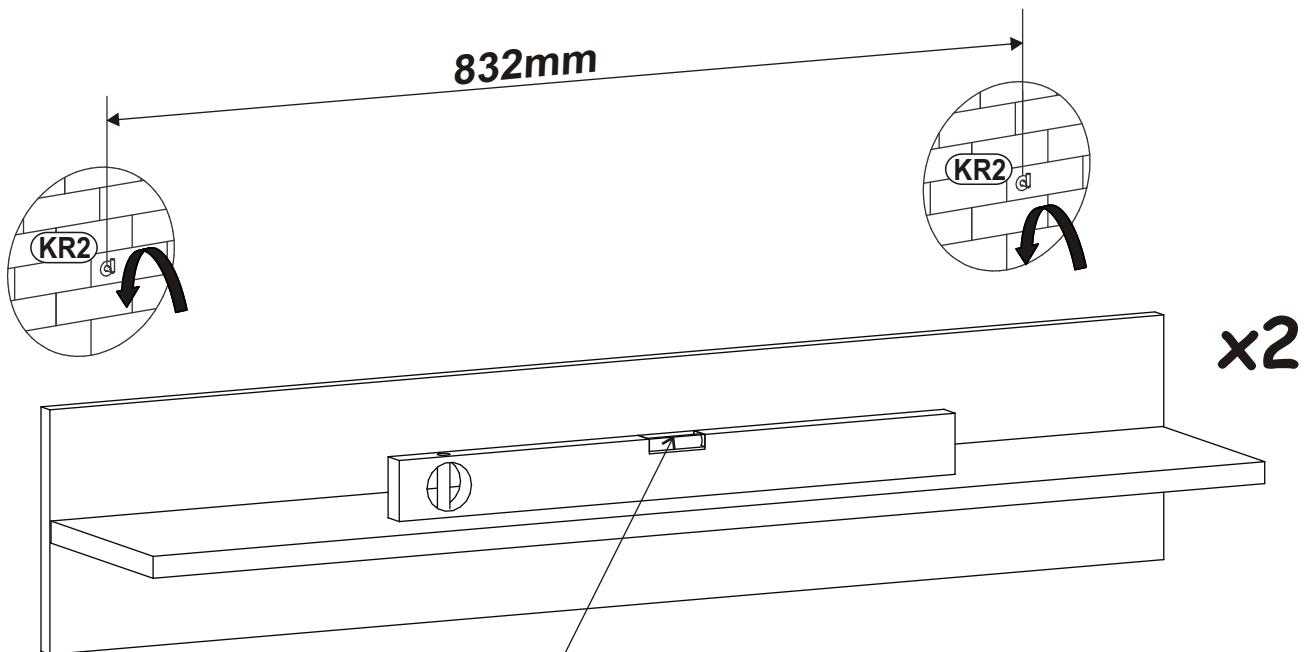
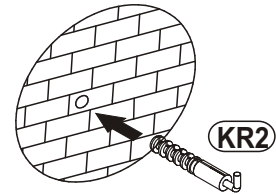
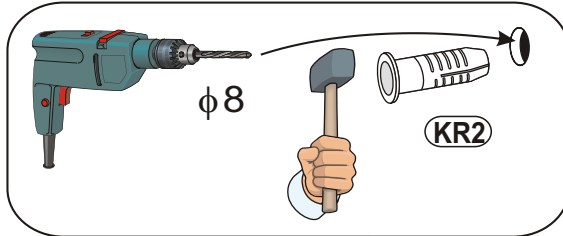
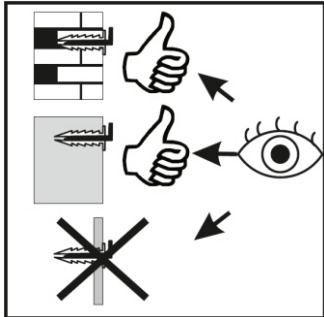

4

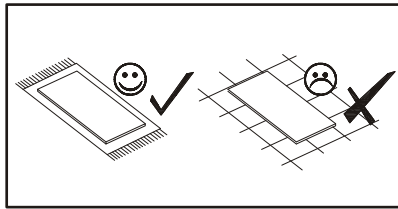

ZM1
x4

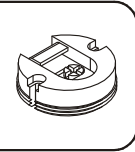

D20
x8

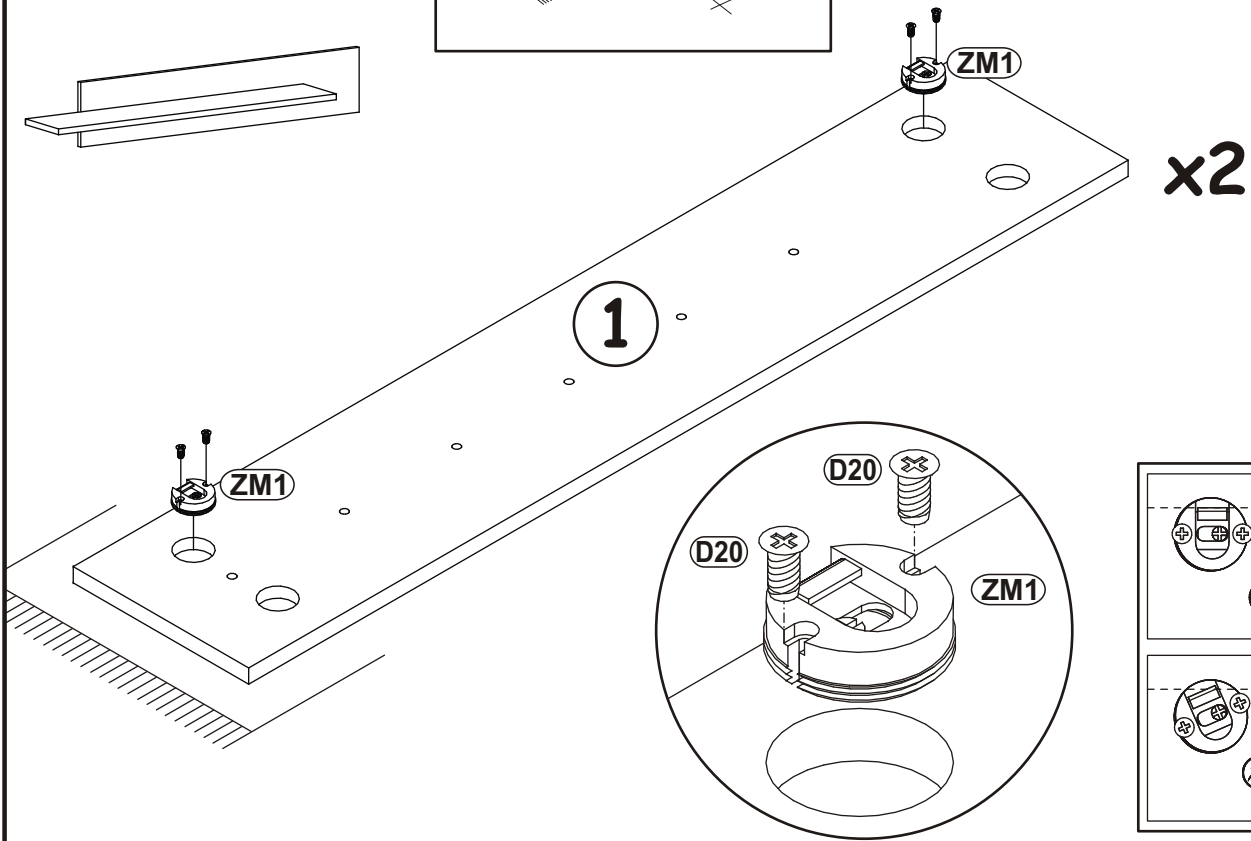
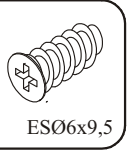

5

B11
x12

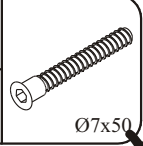

G4
x12

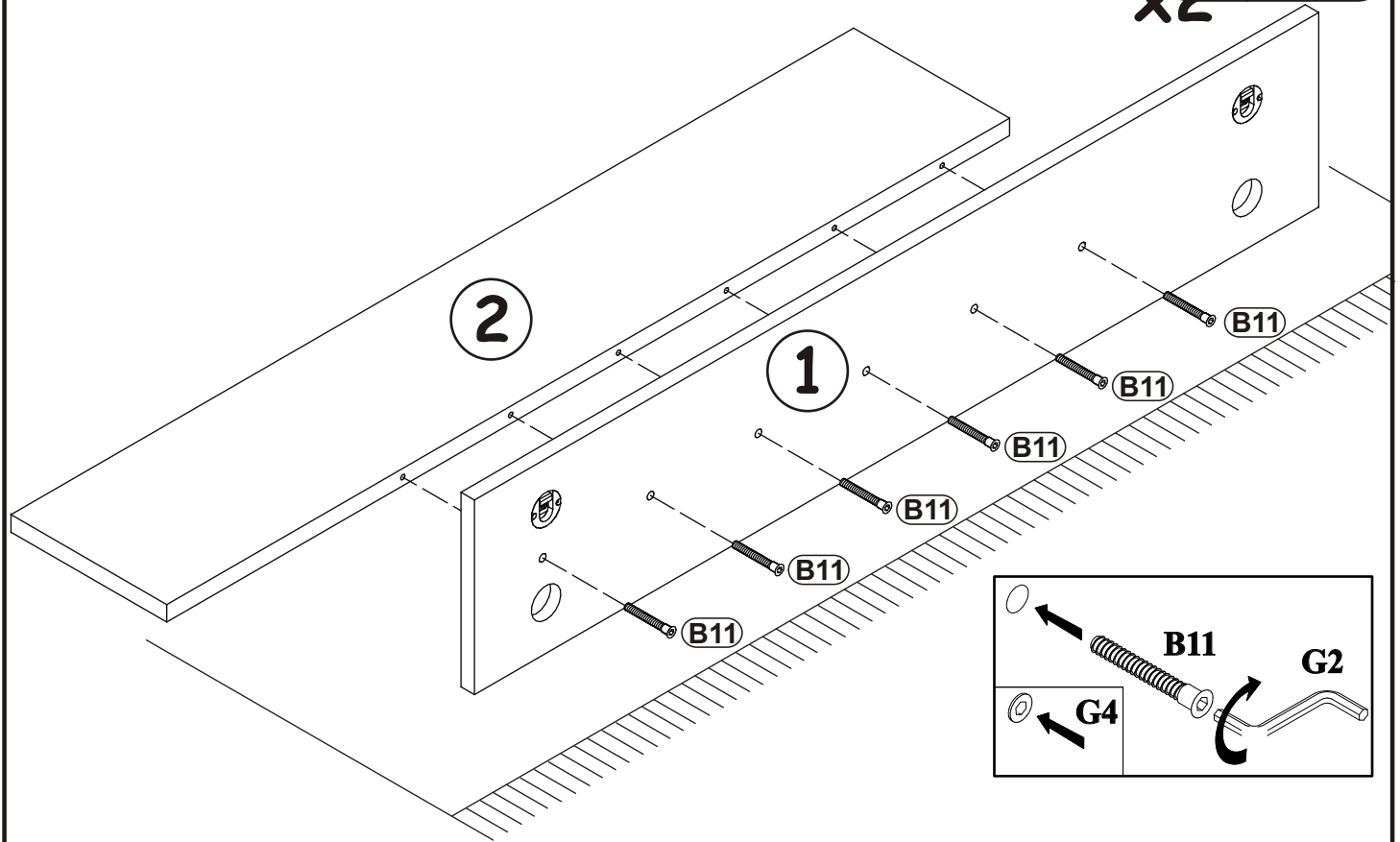

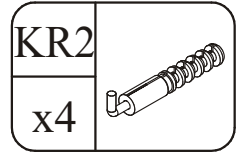

6

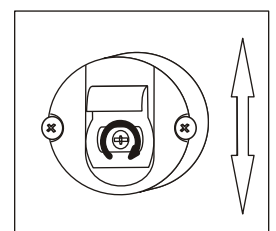
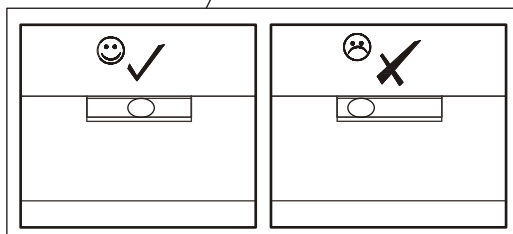
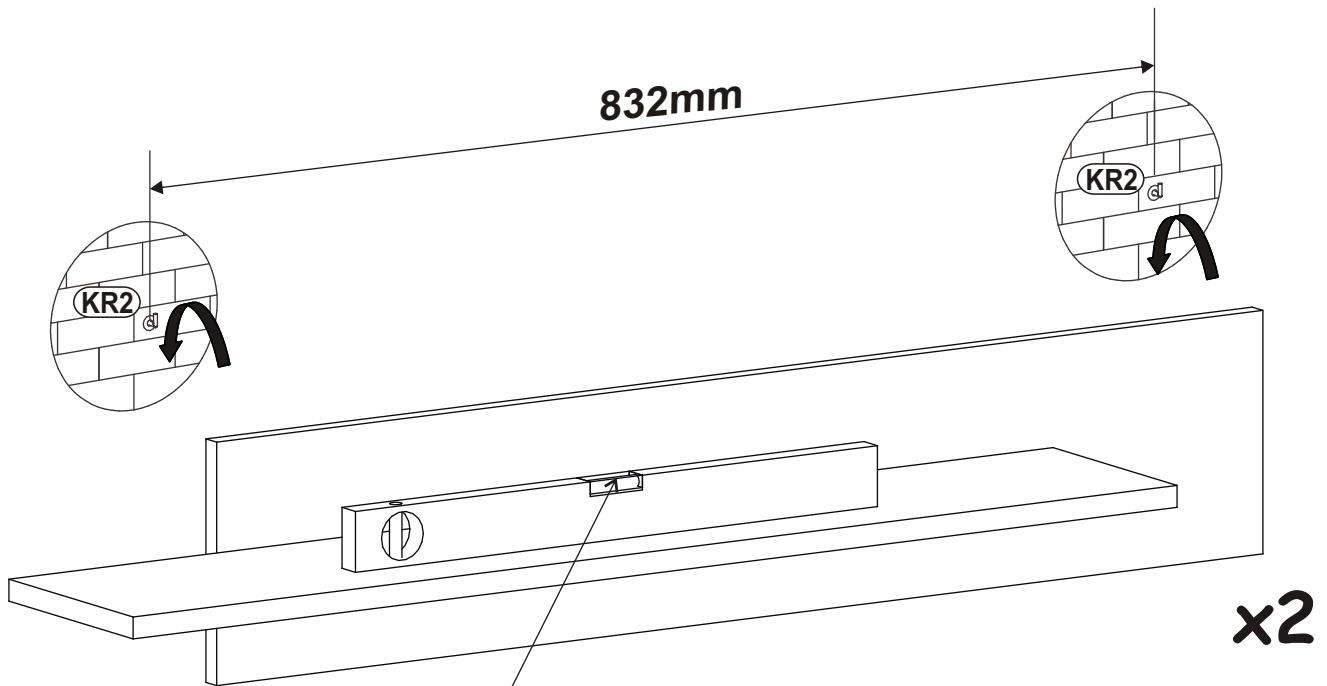
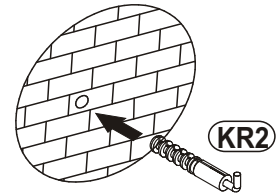
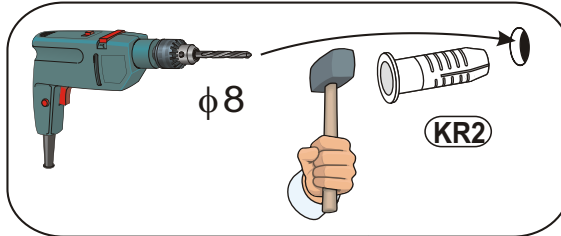
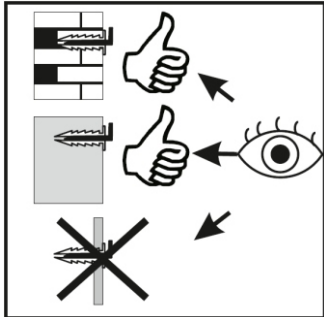

7

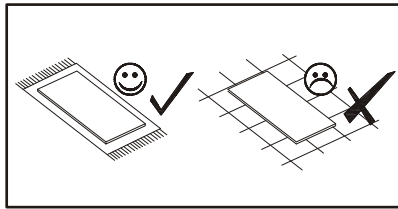

ZM1		D20	
x4		x8	ESØ6x9,5

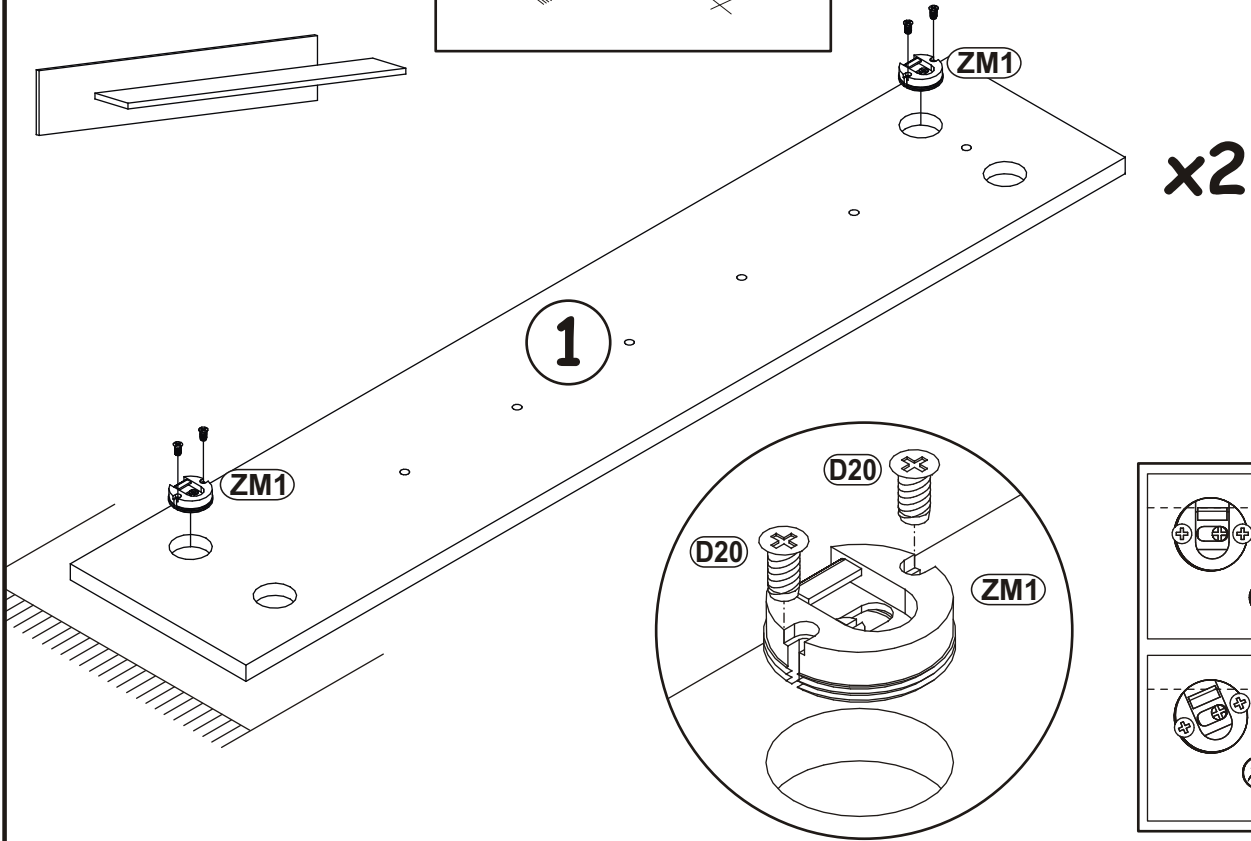

8

B11		G4	
x12	Ø7x50	x12	

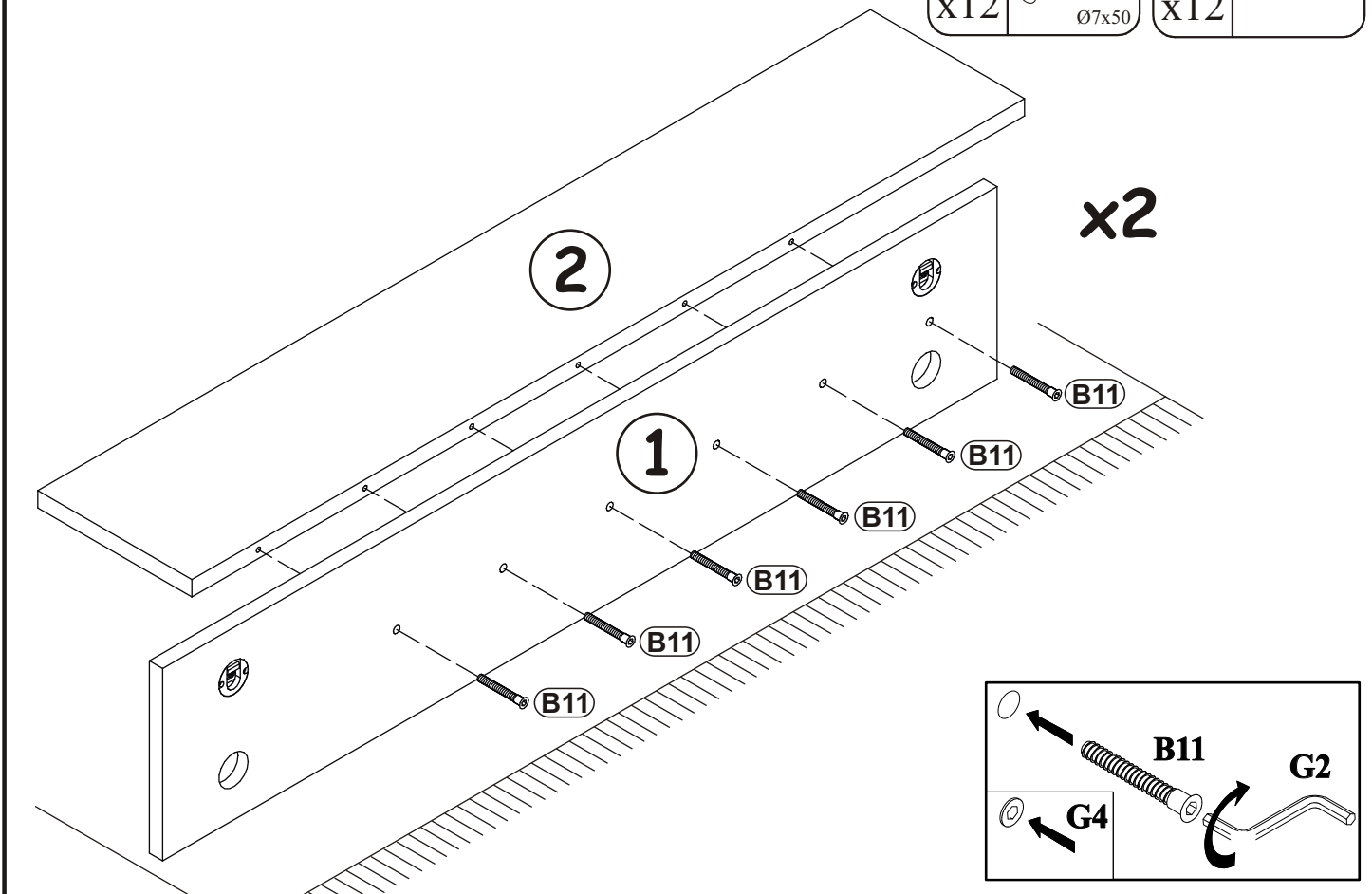

9

