

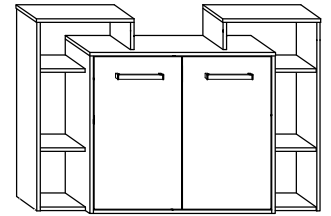

RIO-05 KOMODA 2D

→ 127 + 86 \ 41



x 14 (a)	x 28 (b)	x 28 (c)	x 16 (d)	x 4 (e)	x 4 (f)
x 10 (g)	x 8 (h)	x 8 (3,5x16) (i)	x 50 (k)		x 1 (l)
x 2 (j)				 60 min	



1 - FAZY MONTAŻU

(A) - OZNACZENIE ELEMENTÓW

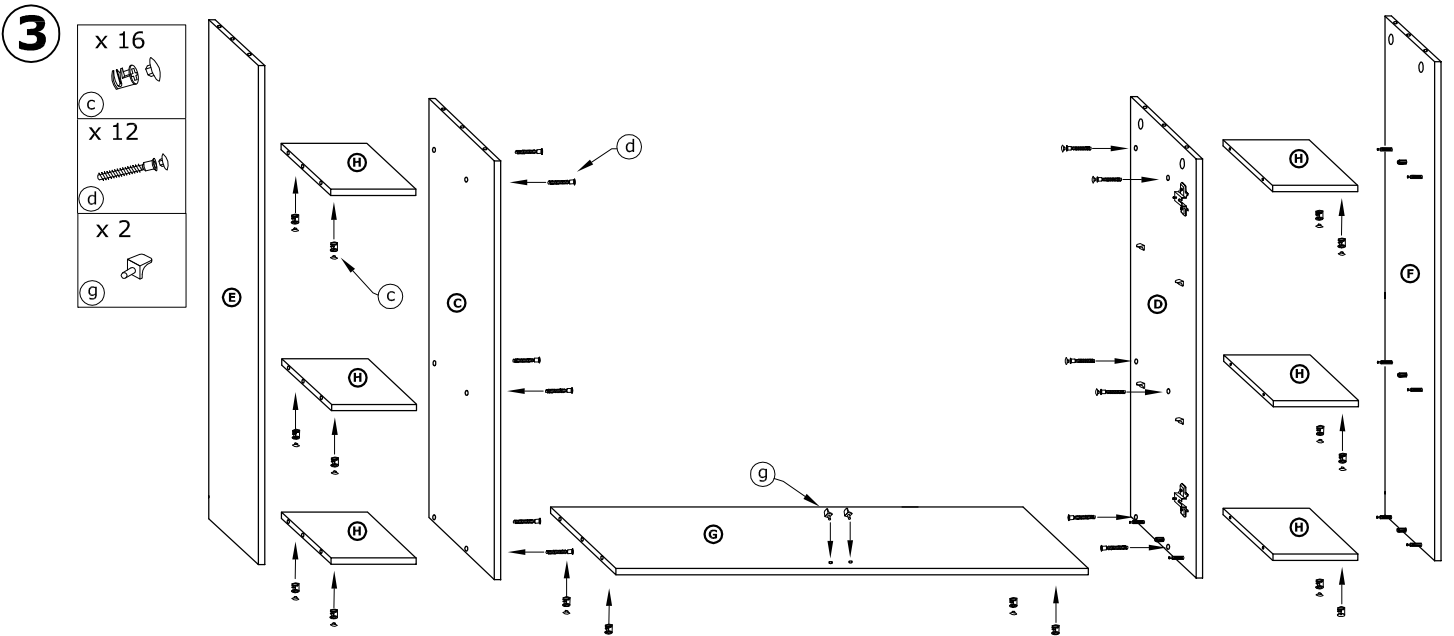
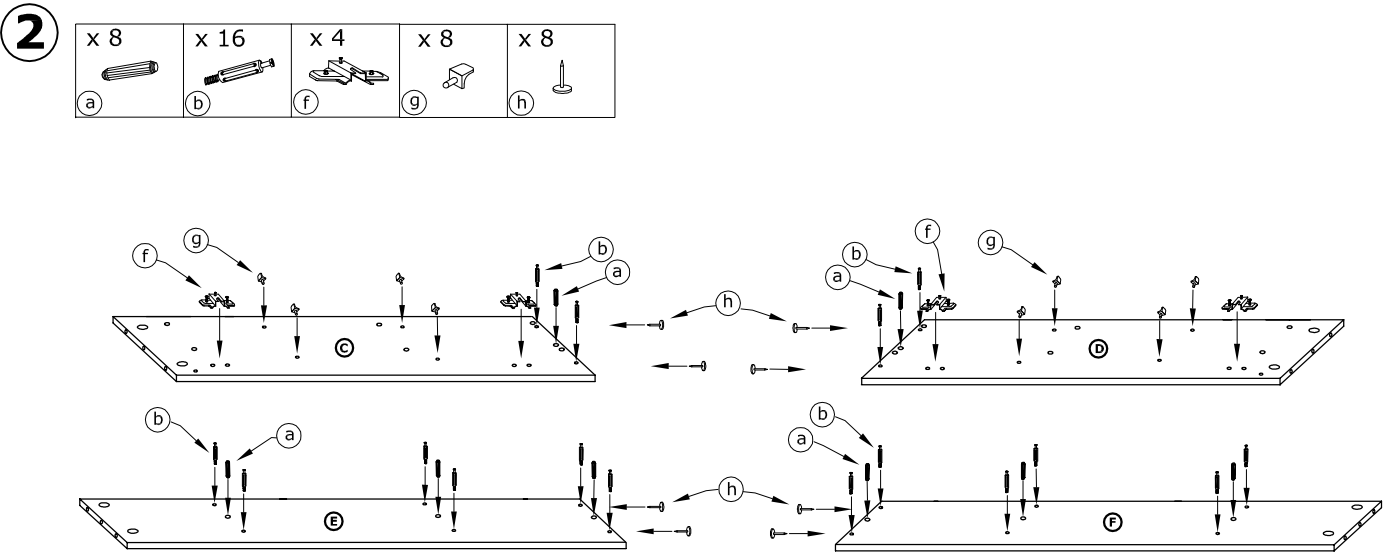
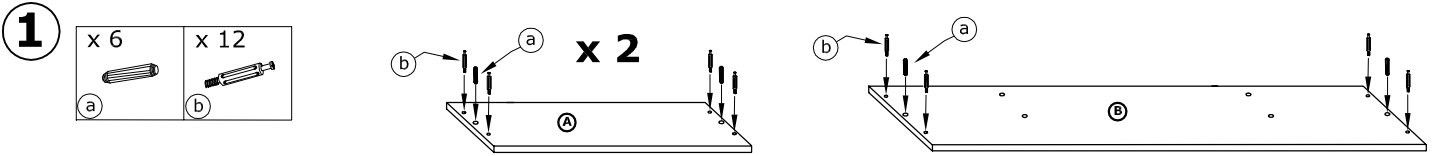
(a) - OZNACZENIE AKCESORIÓW



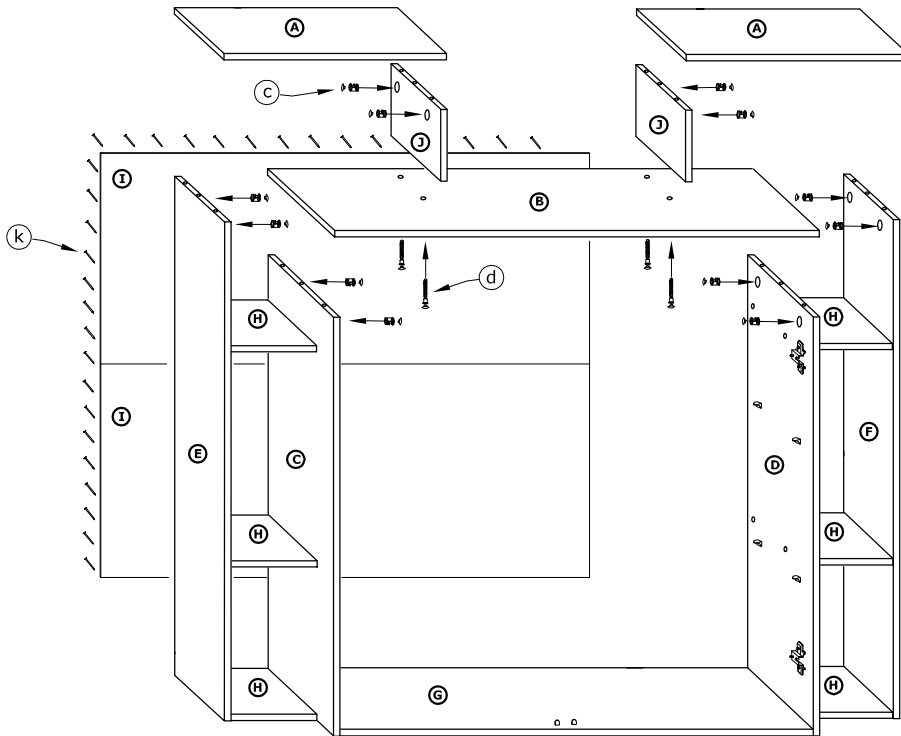

4

- x 12 
- x 4 
- x 50 



5

- x 4 
- x 8 (3,5x16) 
- x 2 

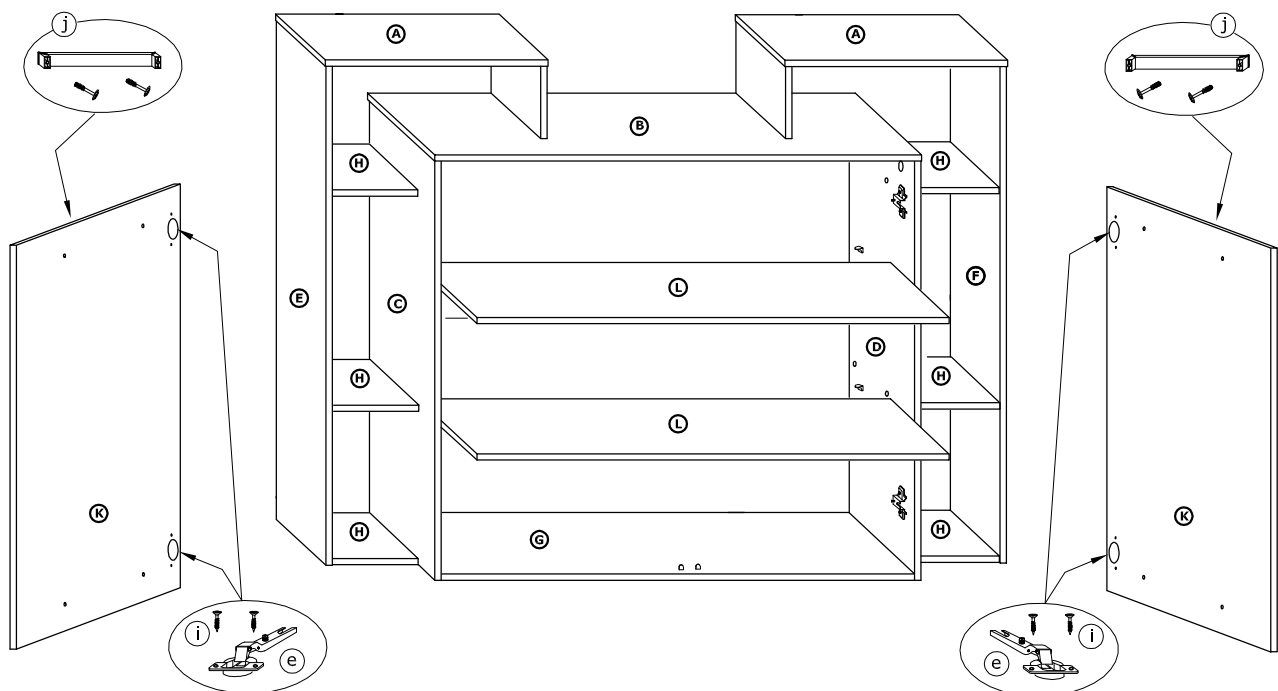



RIO-15

PÓŁKA 1D

→ 127 + 50 \ 29

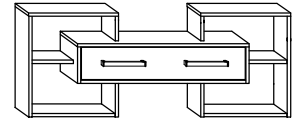

x 12



(a)

x 32



(b)

x 32



(c)

x 15



(d)

x 3 kpl.

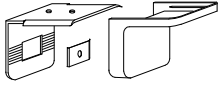

(e)

x 2

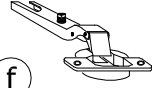

(f)

x 2

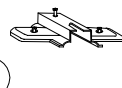

(g)

x 1

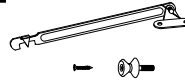

(i)

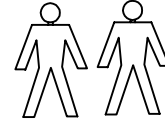

40 min



x 2



(j)

x 6

(3,5x16)



(k)

x 6

(6,2x13)



(l)

x 1



(m)

x 2

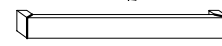

(h)

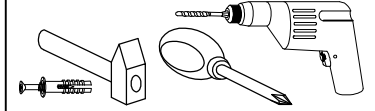
**1** - FAZY MONTAŻU**A** - OZNACZENIE ELEMENTÓW**a** - OZNACZENIE AKCESORIÓW**1**

x 22



(b)

x 10



(d)

x 3



(e)

x 2



(g)

x 6

(6,2x13)

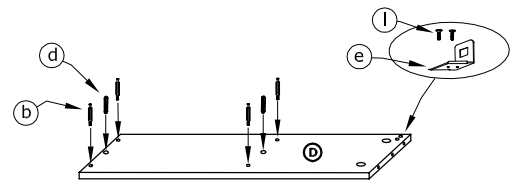
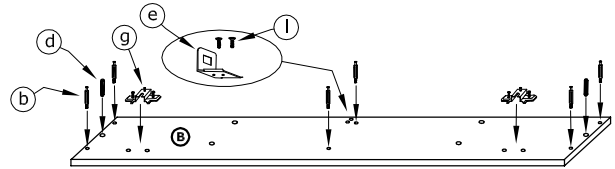
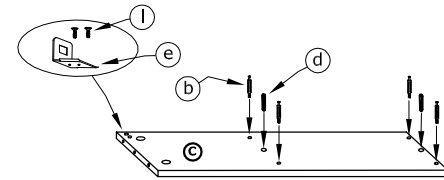
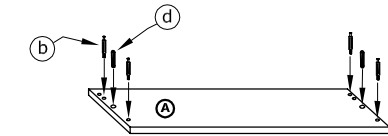
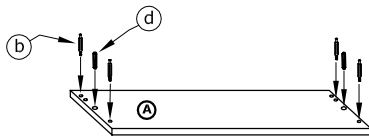

(l)

**2**

x 8



(b)

x 4



(d)

x 1

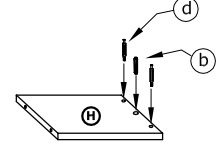
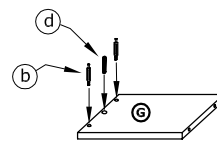
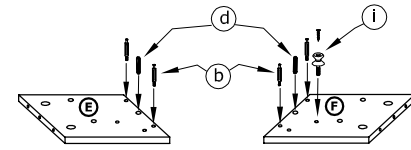

(i)

**3**

x 8



(a)

x 2



(b)

x 6



(c)

x 1



(d)

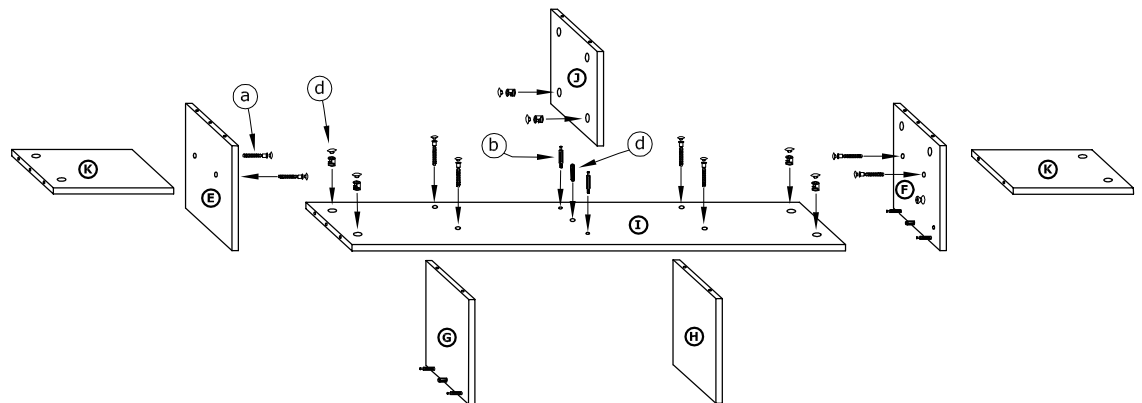

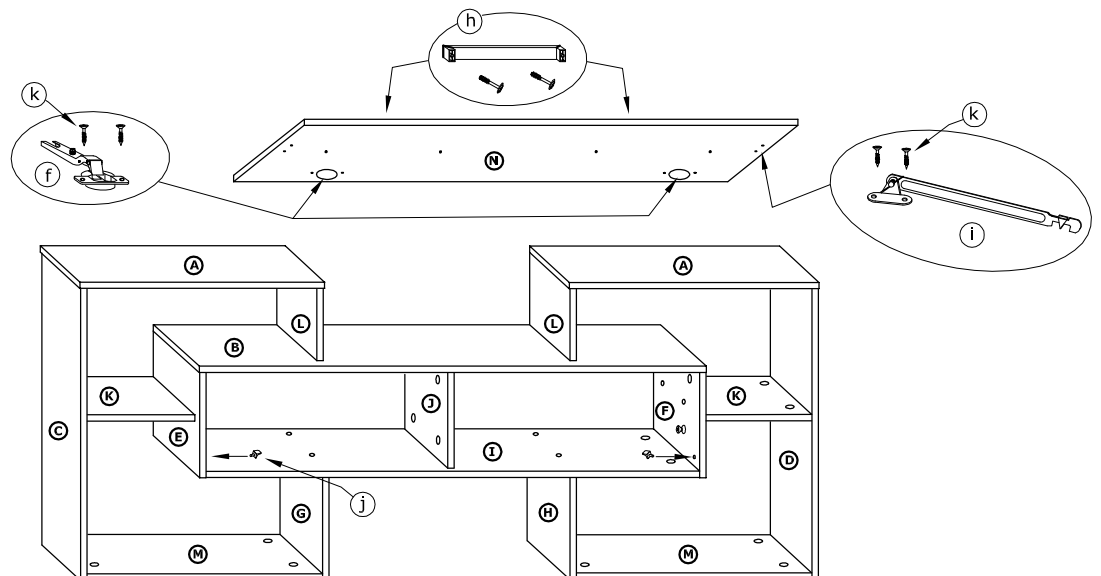
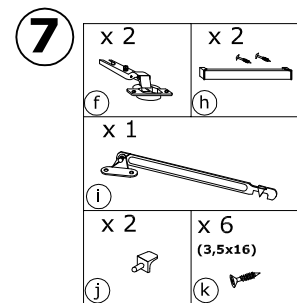
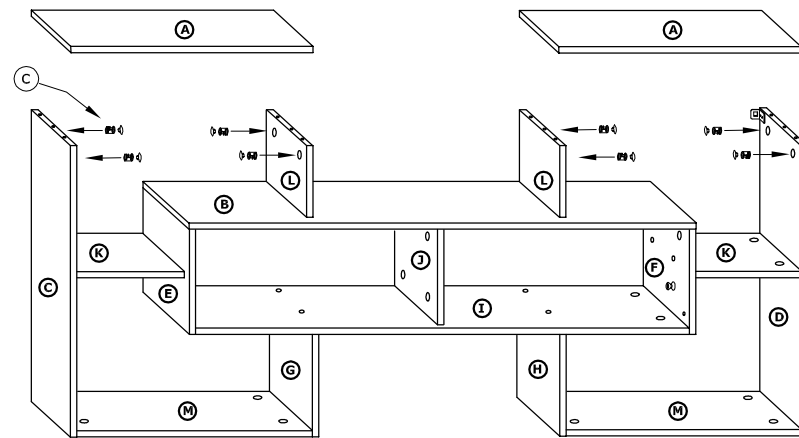
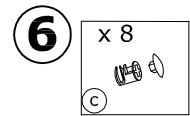
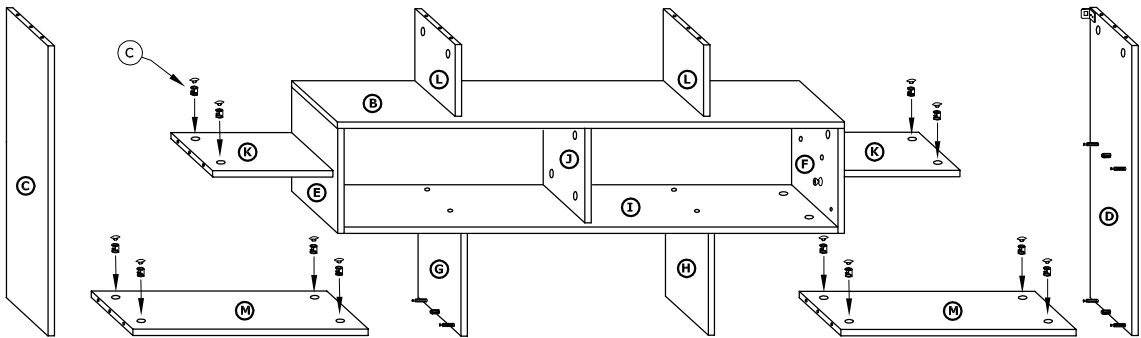
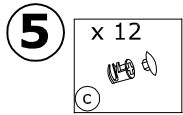
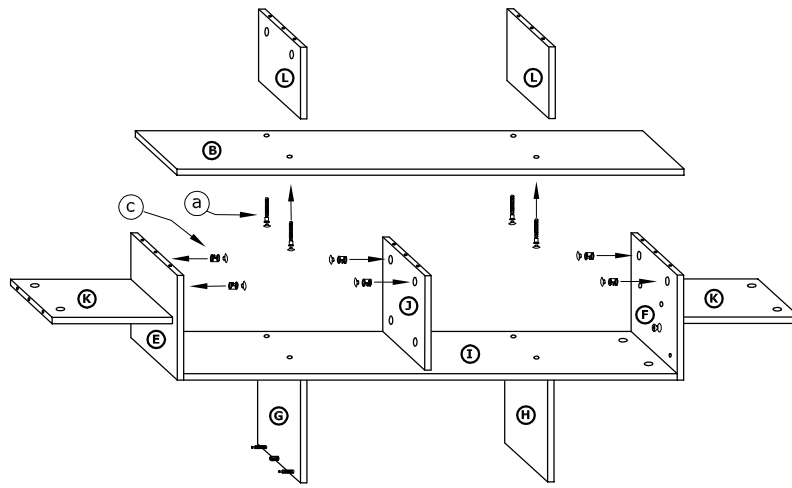
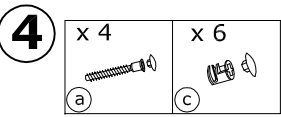



RIO-20 STOLIK RTV

→ 127 ↑ 48 ↘ 38

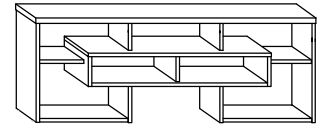

x 15



(a)

x 30

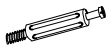

(b)

x 30



(c)

x 14



(d)

x 8



(e)

x 1

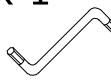

(f)

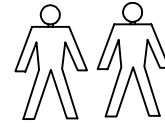
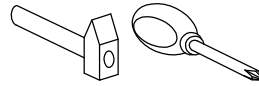

30 min



1 - FAZY MONTAŻU

A - OZNACZENIE ELEMENTÓW

a - OZNACZENIE AKCESORIÓW

1

x 7



(a)

x 14



(b)

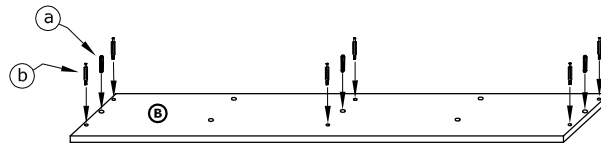
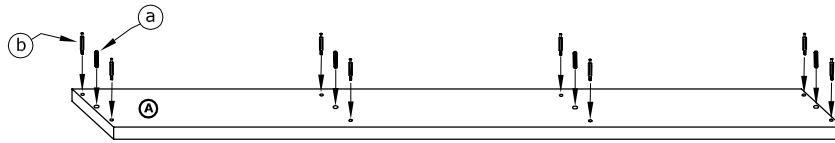

2

x 8



(a)

x 16



(b)

x 8



(e)

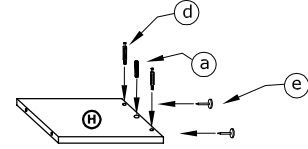
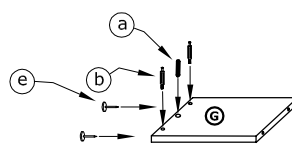
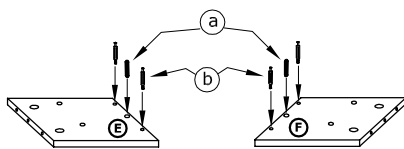
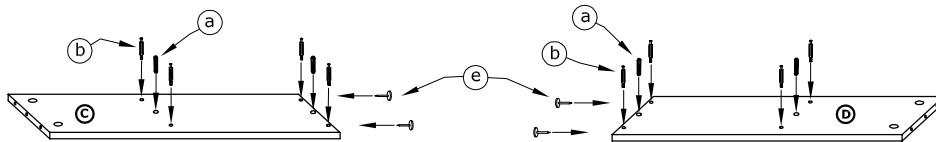

3

x 4



(c)

x 10



(d)

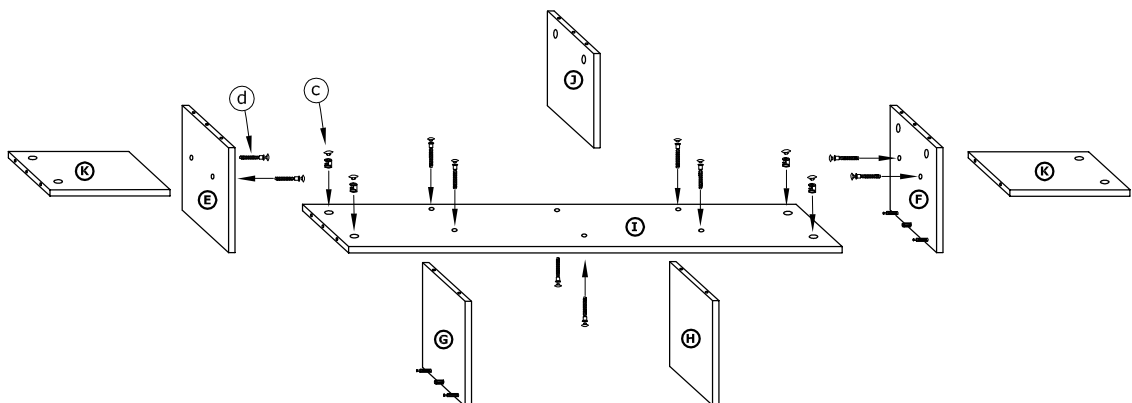

4

x 6

x 4

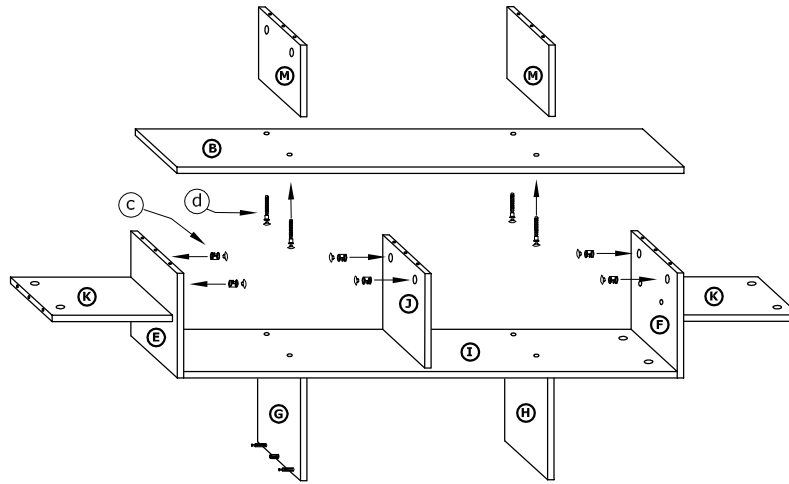
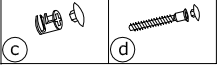

5

x 12

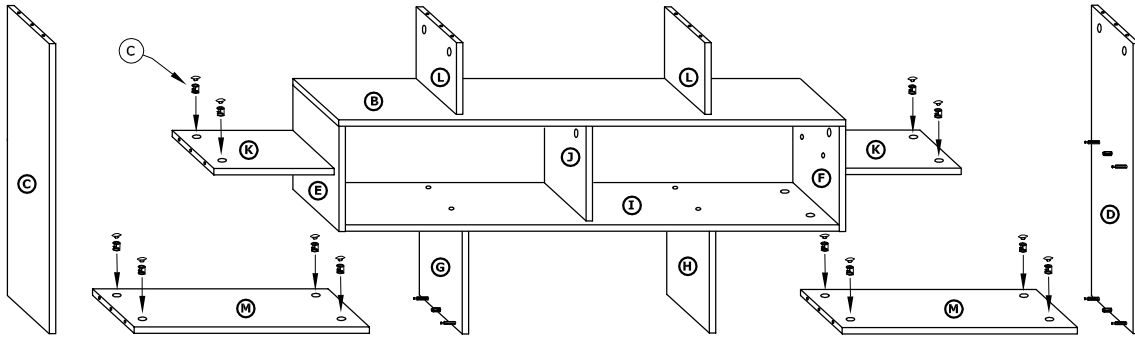

6

x 8

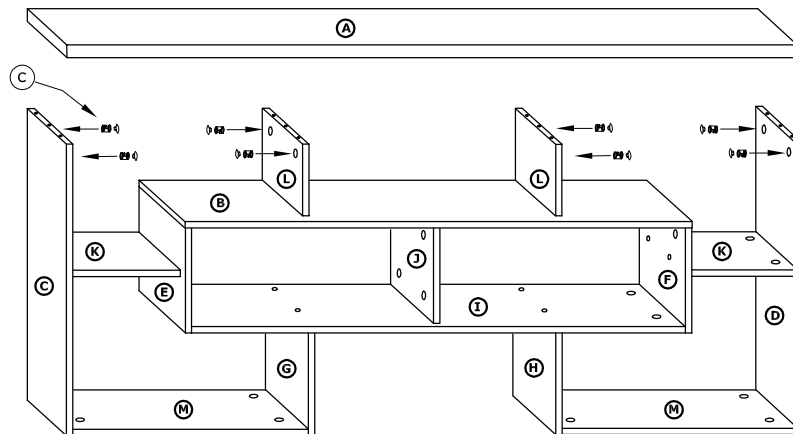
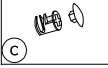









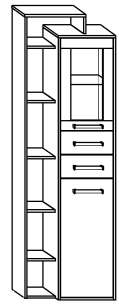







RIO-27

WITRYNA L1D2S

→ 64 + 203 \ 41

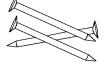
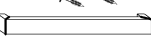
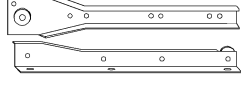

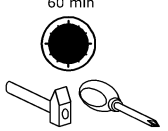
x 14  (a)	x 28  (b)	x 28  (c)	x 22  (d)	x 4  (e)	x 4  (f)
x 14  (g)	x 6  (h)	x 4  (i)	x 32 (3,5x16)  (j)	x 8 (3,5x30)  (k)	x 70  (m)
x 4  (l)	x 2 kpl. (350 mm)  (o)			  60 min	



1 - FAZY MONTAŻU

A - OZNACZENIE ELEMENTÓW

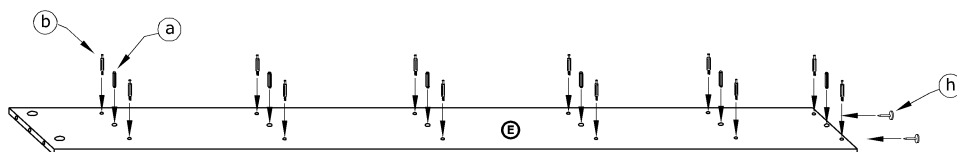
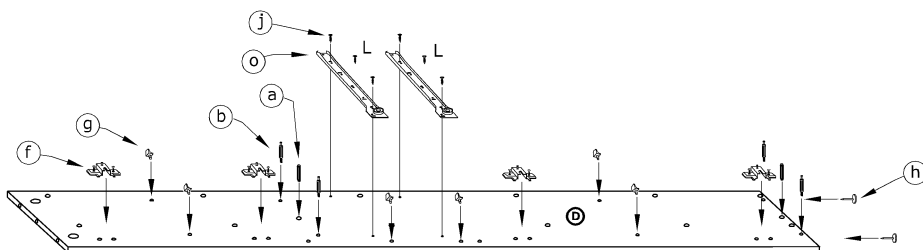
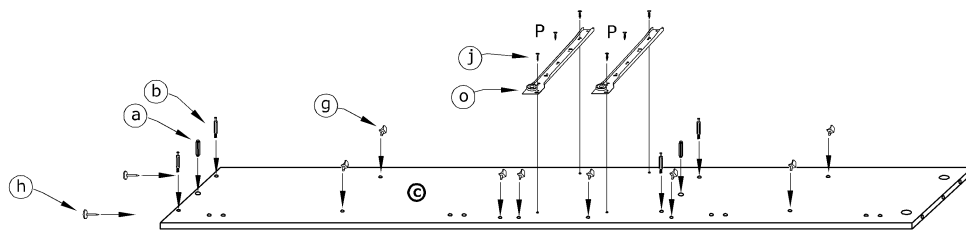
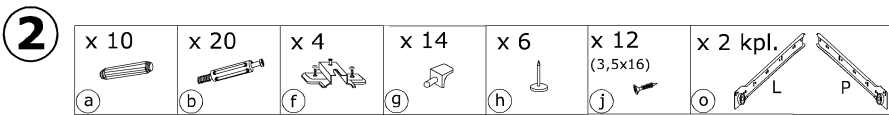
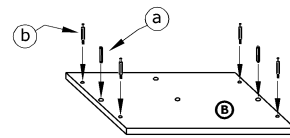
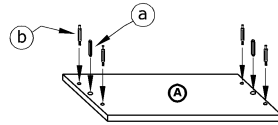
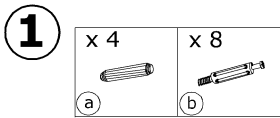
a - OZNACZENIE AKCESORIÓW



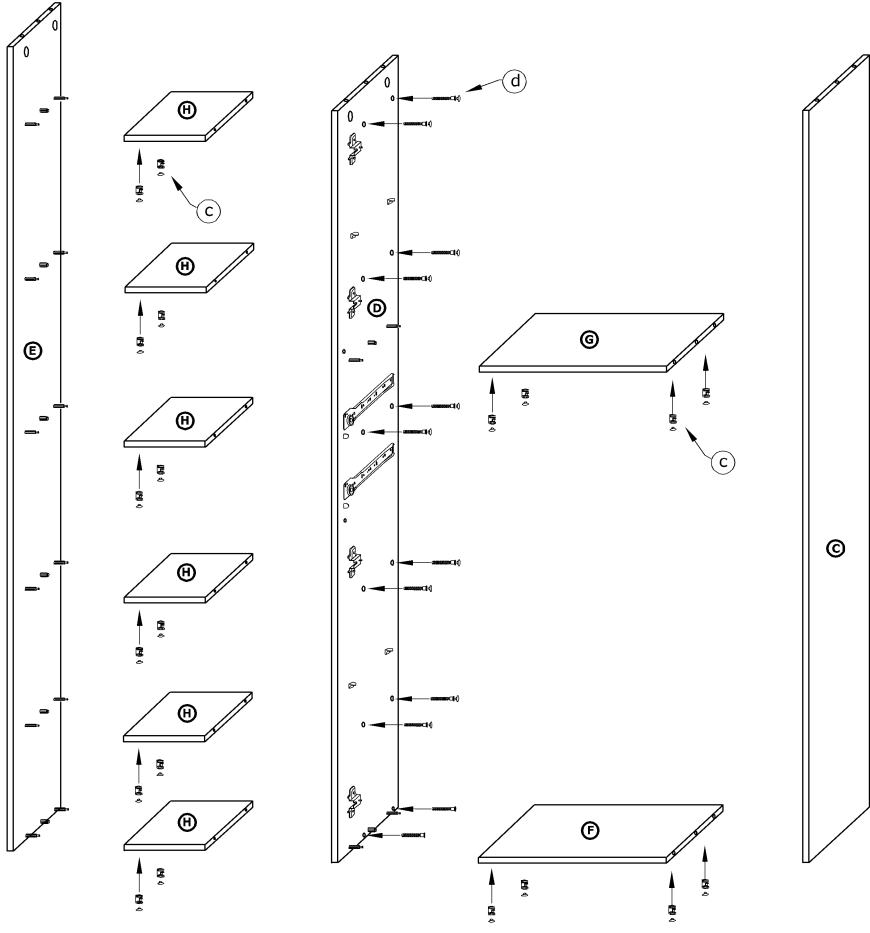

3

- x 20
- (c) 
- x 12
- (d) 



4

- x 8
- (c) 
- x 2
- (d) 

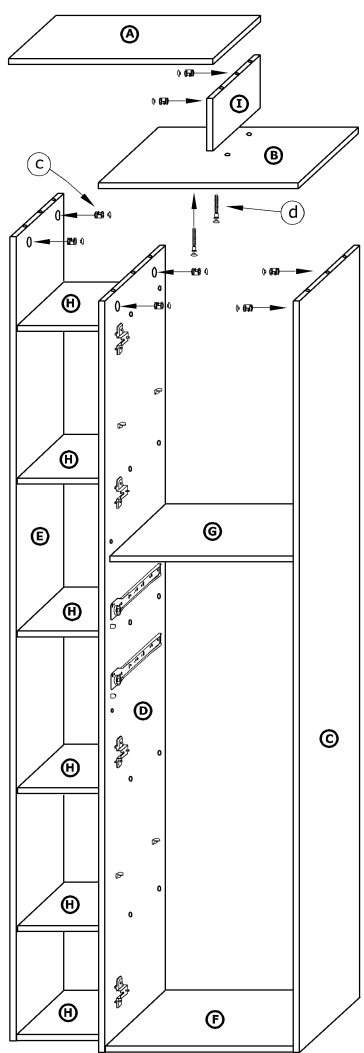

5

x 40

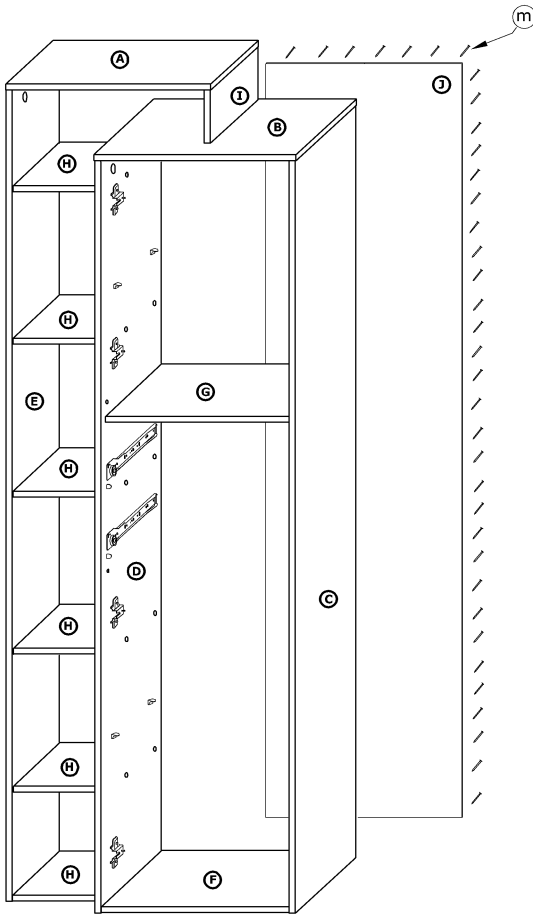

6

x 8



x 4



x 12

(3,5x16)



x 4

(3,5x30)



x 2



x 30



x 2 kpl.

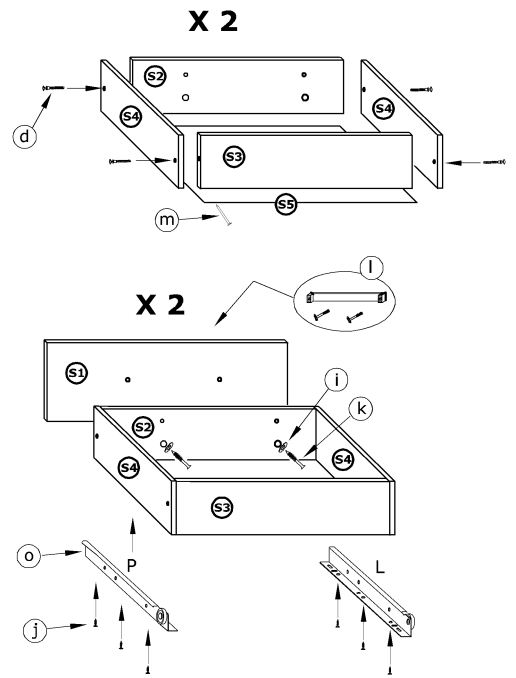
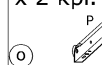

7

x 4



x 8

(3,5x16)



x 4

(3,5x30)



x 2

