







XAVIER

 max. 40 kg

A		1
B		2
C		2
D		4
E		16
F		16

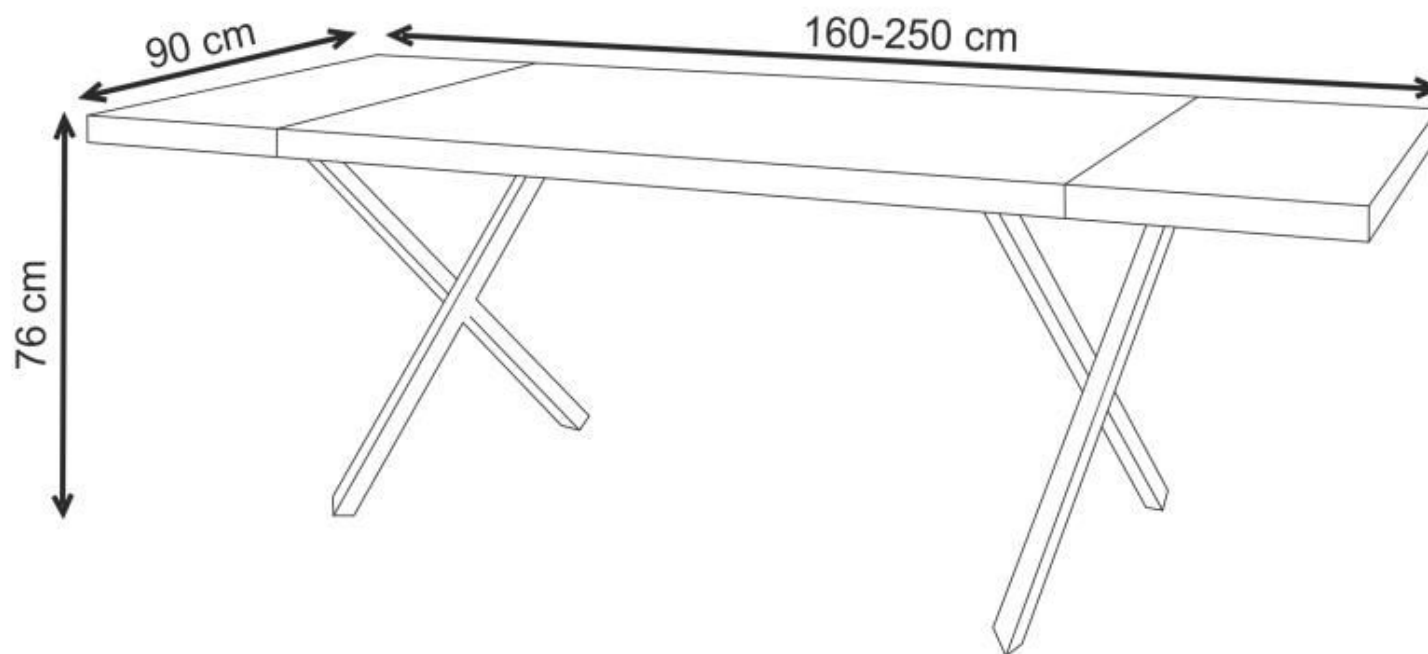

XAVIER



1. Nogi należy przykręcić do wyfrezowanego miejsca pod blatem z prawej i lewej strony. Jedną nogę należy zamocować przy pomocy 8 śrub F.

Legs should be screwed to the milled place under the top on the right and left side. Each leg must be screwed by using 8 pcs of screws „F”.



2. Do każdej wkładki należy przykręcić dwie prowadnice, każda z nich mocowana 2 śrubami „E”.

Each rail should be screwed to extension part of table top by using 2 pcs of screws „E”.



3. Wkładki należy wsunąć prowadnicami w zamontowane pod blatem 2 metalowe otwory następnie każdą wkładkę należy przykręcić do blatu stołu za pomocą 4 śrub „E”.

Each extension part should be inserted into 2 metal holes under the top table and screwed to the table top by using 4 pcs of „E” screws.