

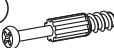



B1  ϕ 8x28 x12

T1  x12

M1  x12

C2  ϕ 20 x12

F1  x3

P2  3x16 x21

Y0  x4
KR0

S8  4x13 x8

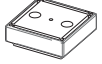
F37  x5

S9  4x16 x10

Nr	Ausmaß			St
1	391	388	18	1
2	388	391	18	1
3	378	379	16	1
4	378	379	16	1
5	378	379	16	1
6	790	379	16	1
7	790	400	16	1
8	405	391	2	2

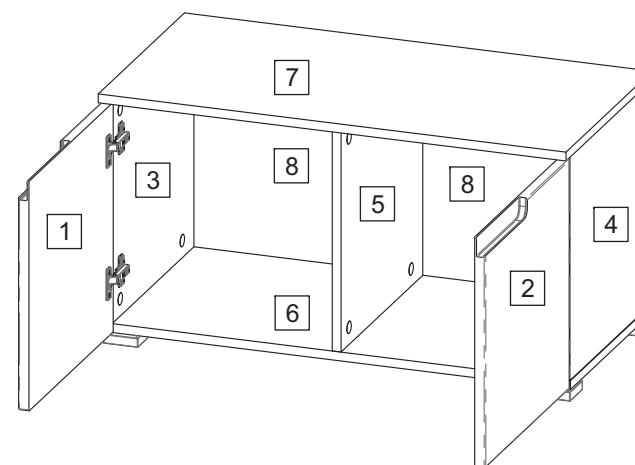

0 10 20 30 40 50 60 70 80 90 100 110 120 130 140 150 160 170 180 190 200



1

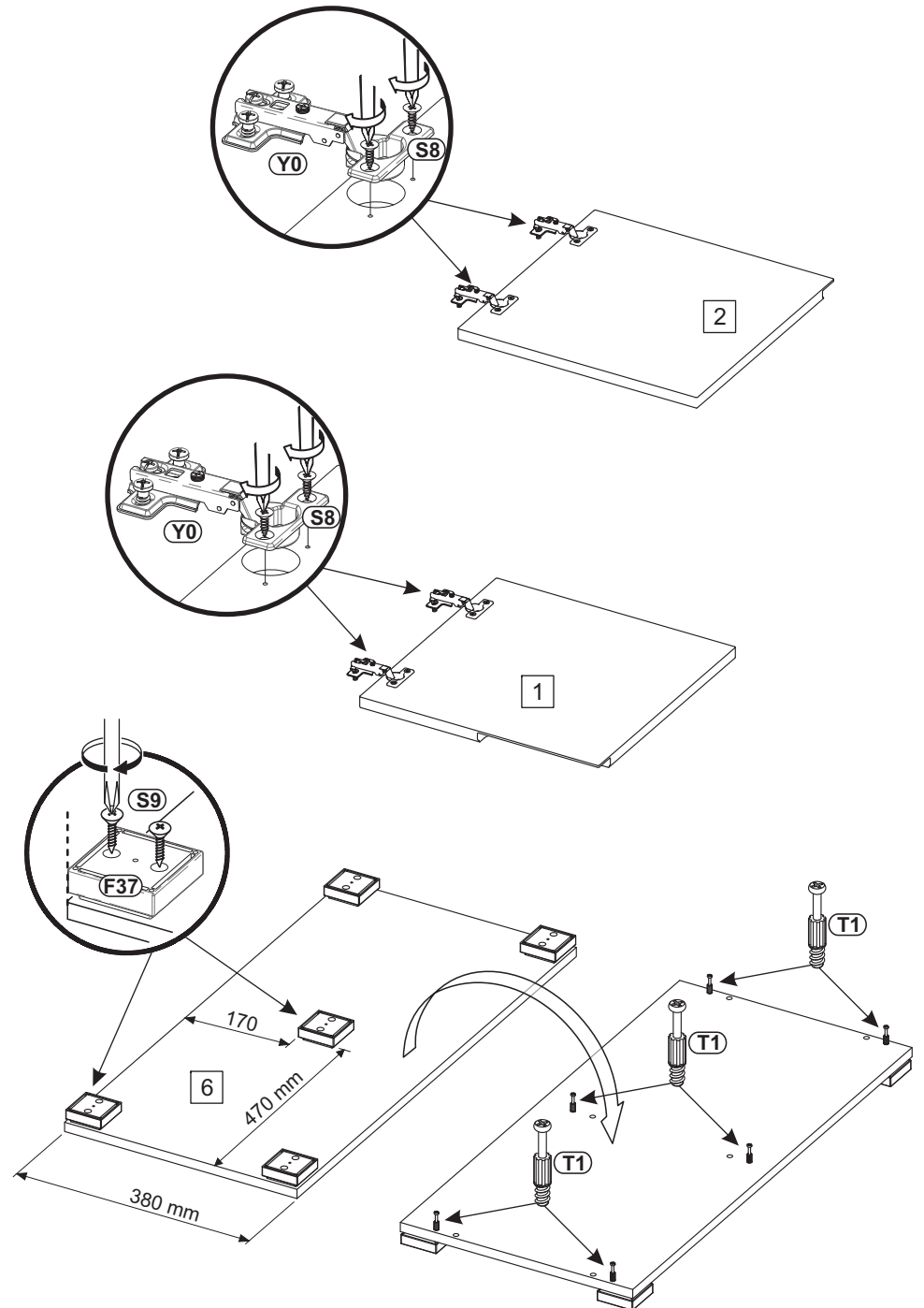
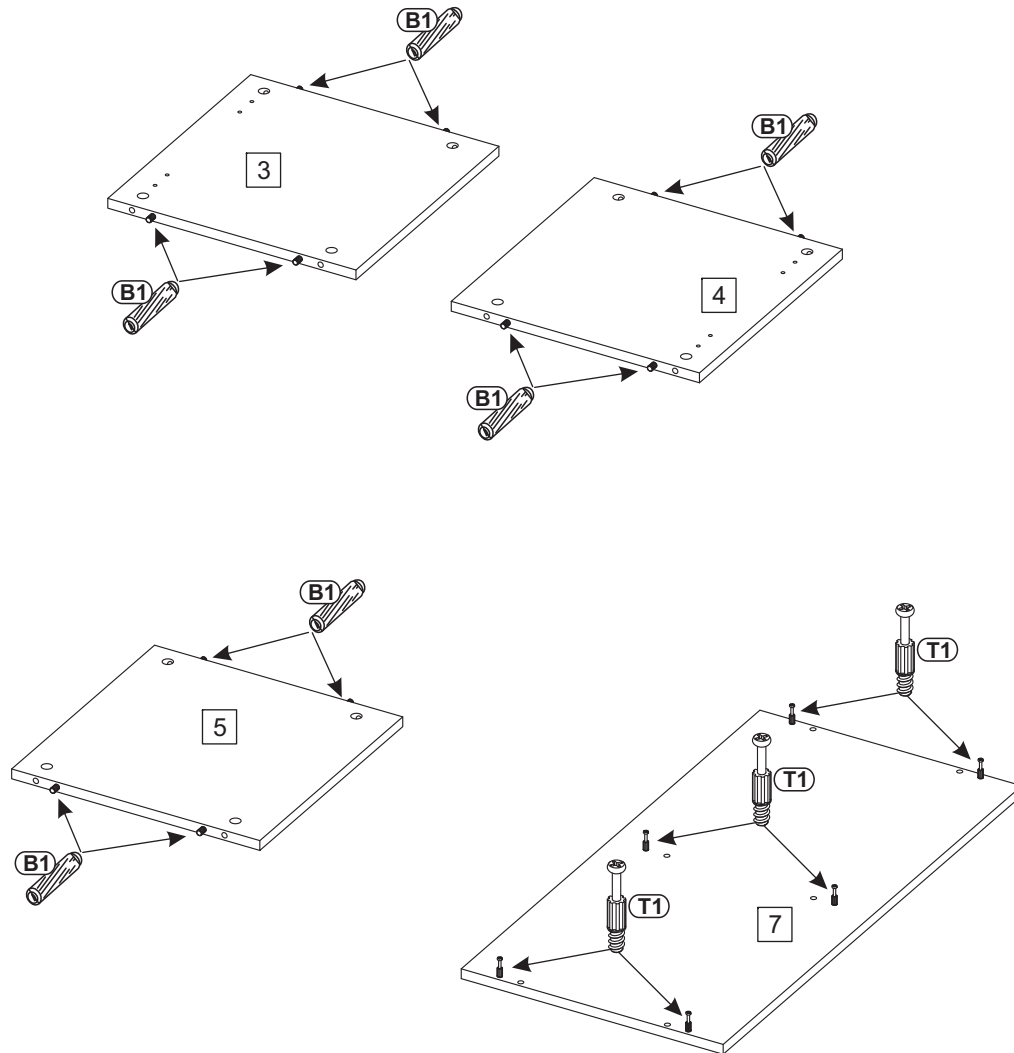
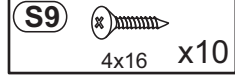
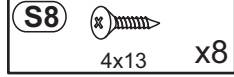
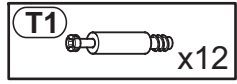
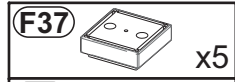
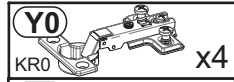
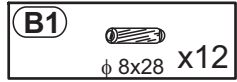

2

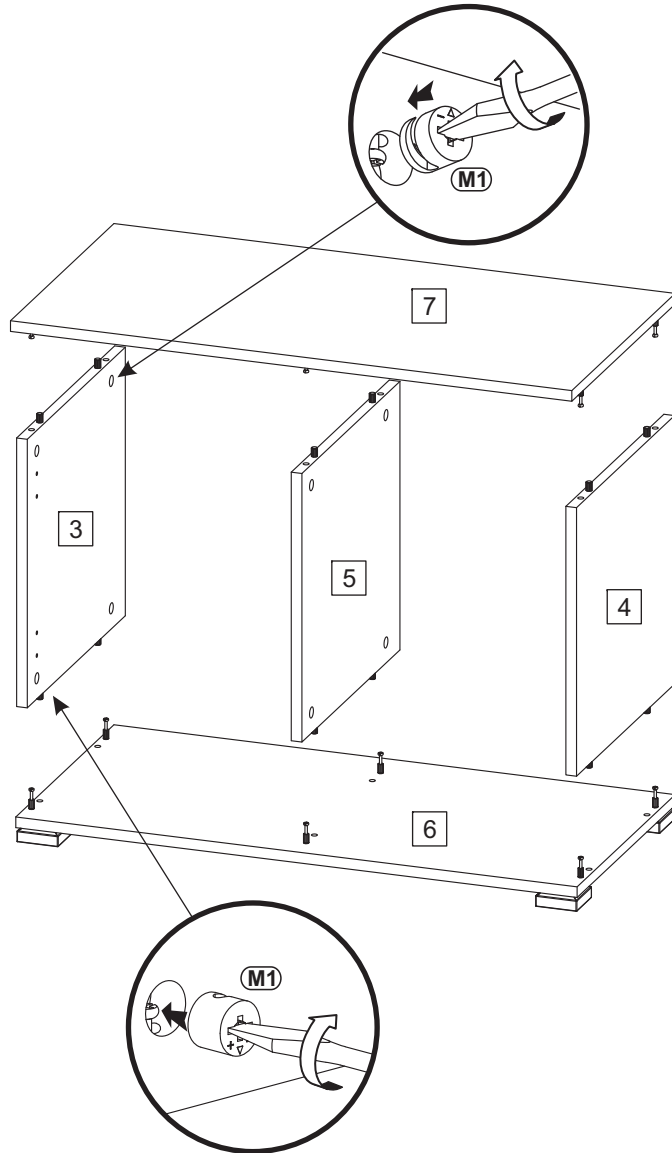

3

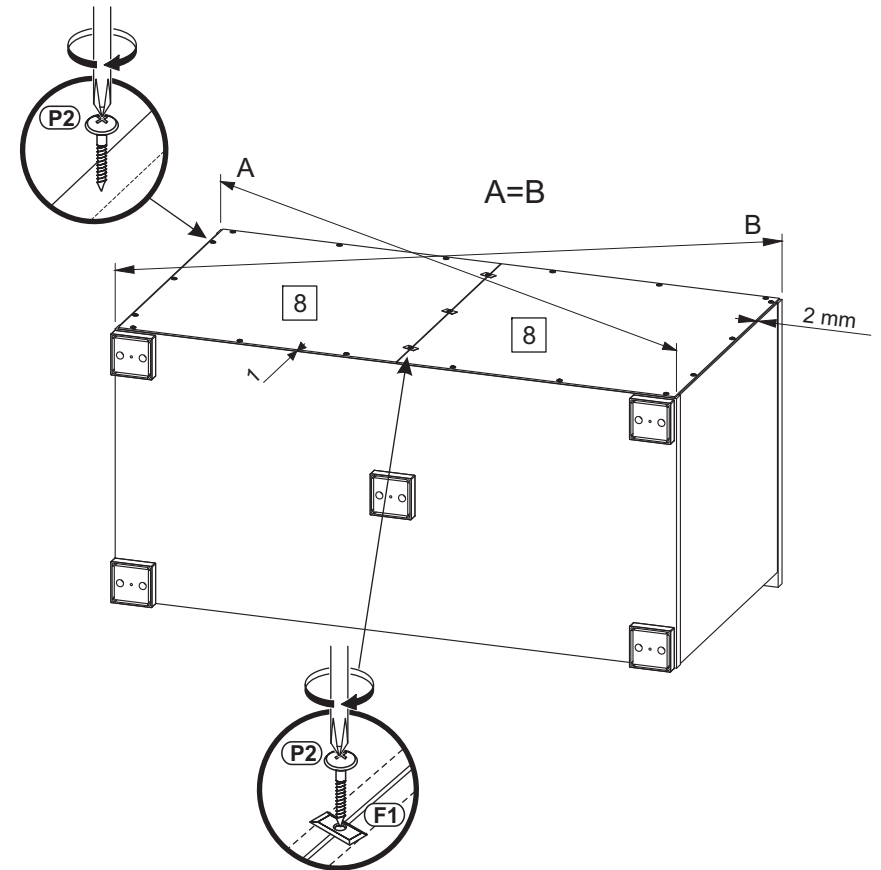
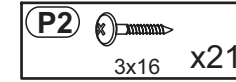
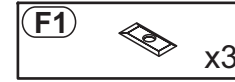

4

C2
φ 20 x12

