

PRZED ROZPOCZĘCIEM MONTAŻU ZAPOZNAĆ SIĘ Z INSTRUKCJĄ

Narzędzia niezbędne do montażu (nie dostarczone przez producenta)

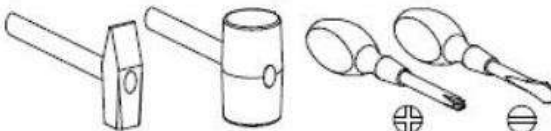
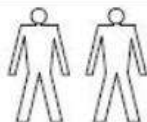

# VIGO

RTV 180

z półką szklaną

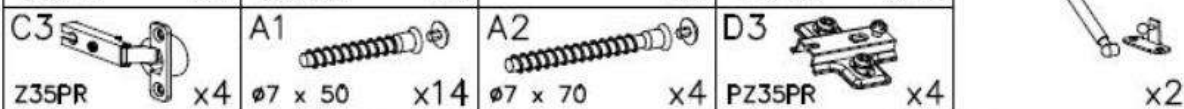
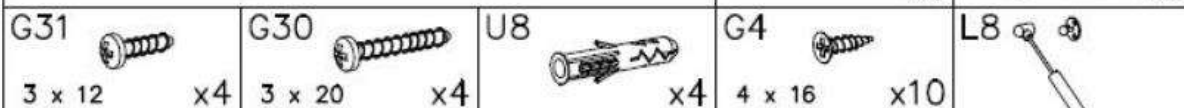
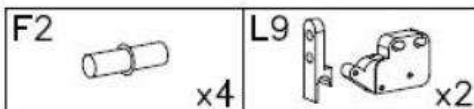
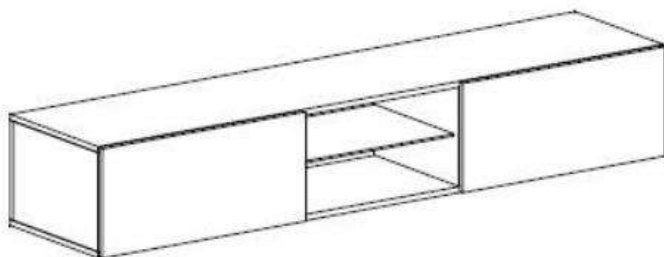

PRZED ROZPOCZĘCIEM MONTAŻU ZAPOZNAĆ SIĘ Z INSTRUKCJĄ

Narzędzia niezbędne do montażu (nie dostarczone przez producenta)

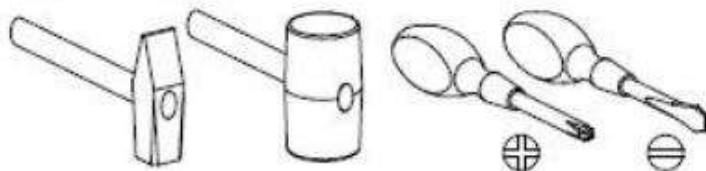
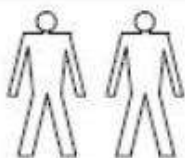
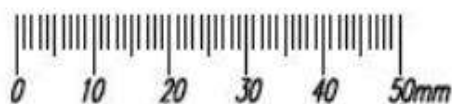

# VIGO

## Witryna

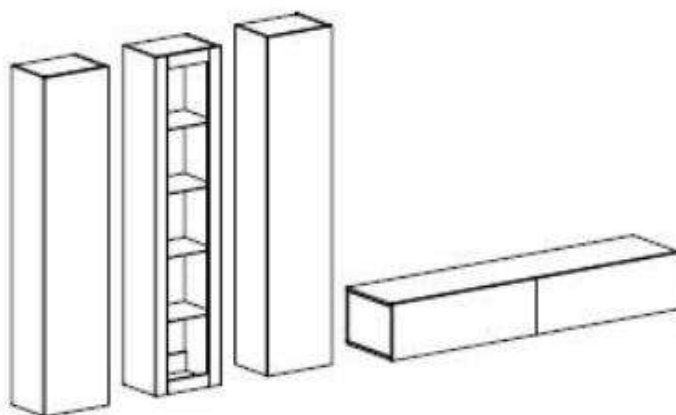
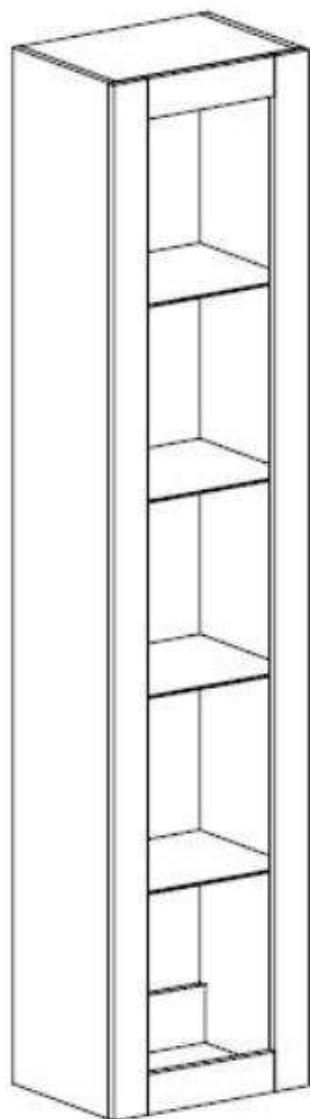



G21  3 x 16 x12

I2  x12

F2  x16

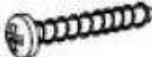
G31  3 x 12 x2

G30  3 x 20 x2

W4  x45

C3  Z35PR x4

L9  x1

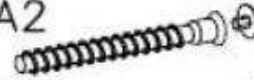
A2   $\varnothing 7 \times 70$  x4

D3  PZ35PR x4

U8  x4

K5  x12

K1   $\varnothing 15 \times 12$  x12

B1  x12

W2  x1

G5  4 x 13 x8

I

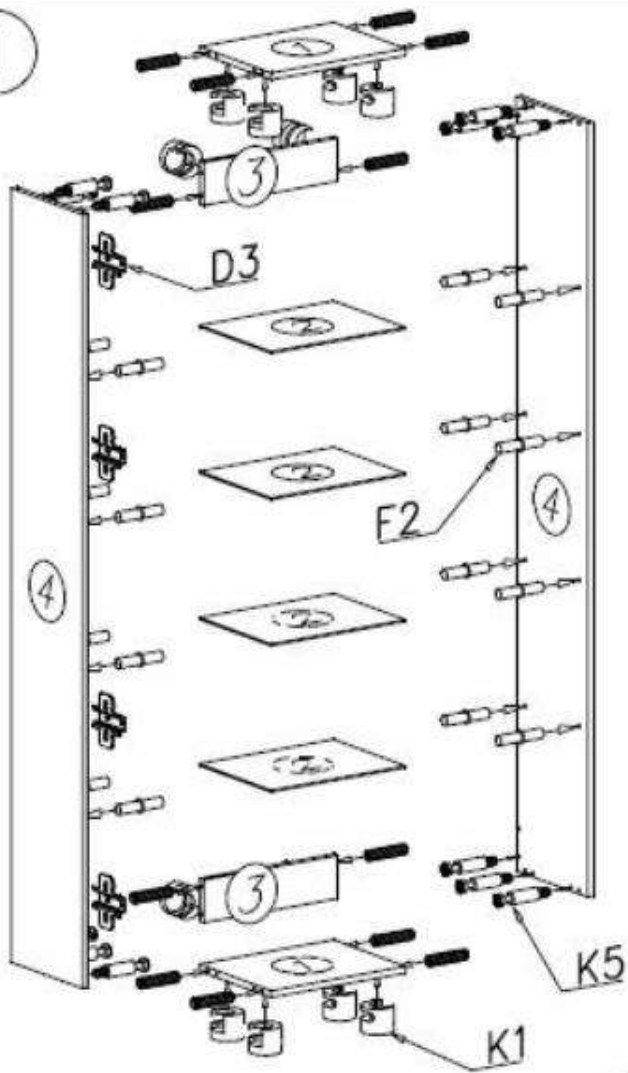

II

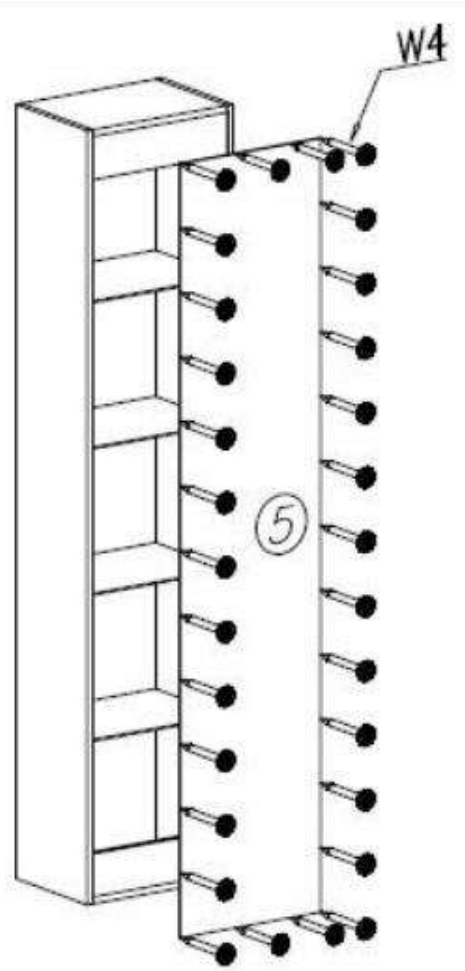

III

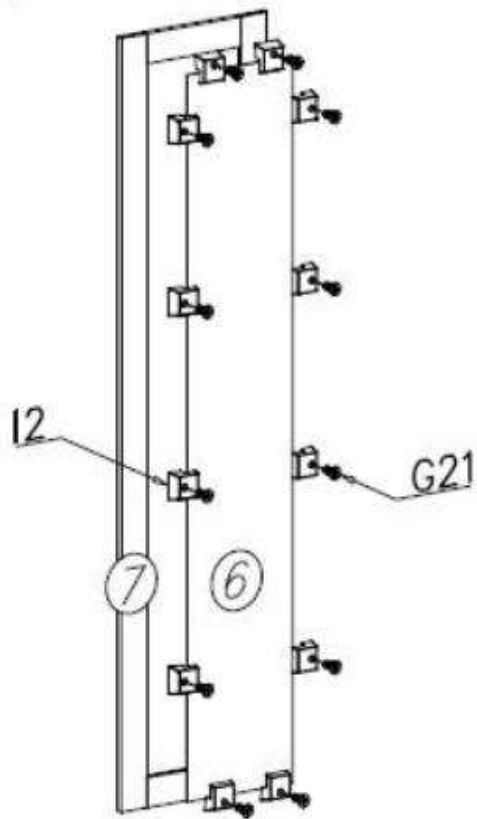

IV

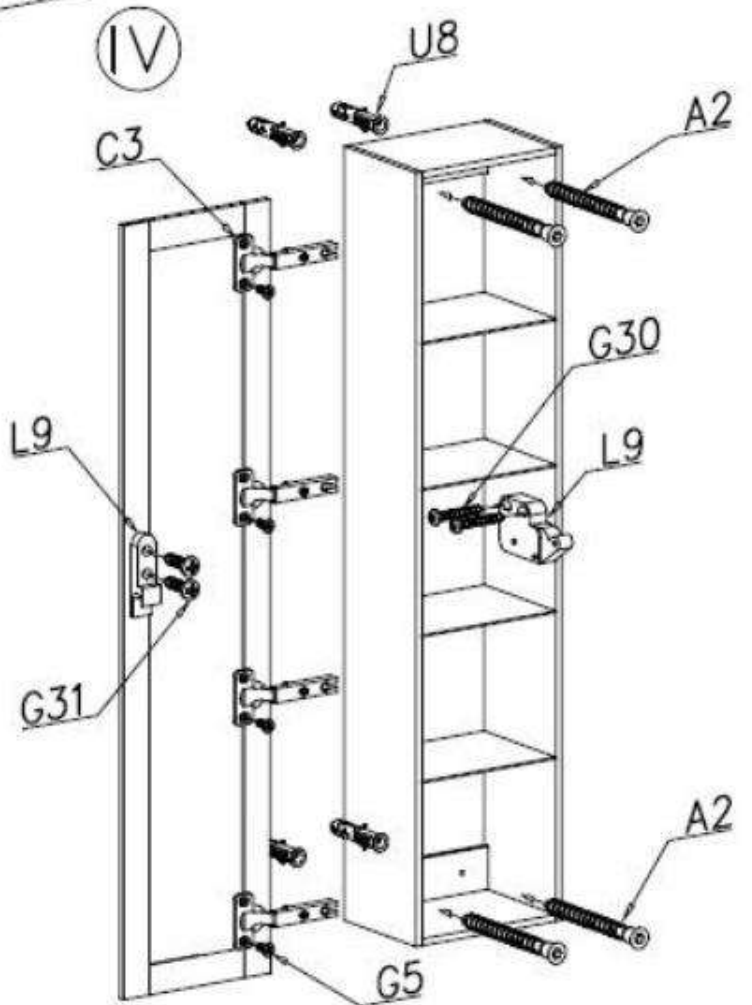

# ODBOJNIKI SAMOOTWIERAJĄCE

**Nowość**

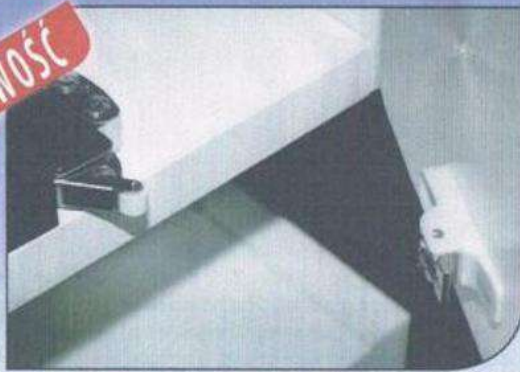

Odbojnik samootwierający

**Przeznaczenie:**

- odbojnik do frontów (front po naciśnięciu otwiera się)
- zaleca się zastosowanie z zawiasem samootwierającym i zawiasem bez sprężyny

**Cechy produktu:**

- otwieranie frontu poprzez lekkie naciśnięcie
- brak konieczności stosowania uchwytych we frontach
- prosty montaż
- niezawodność
- kompletny zestaw montażowy (odbojnik, zastrzak)

**Odbojniki samootwierające z końcówką kauczkową lub magnetyczną**



Index: AM-PLA-DLU-0

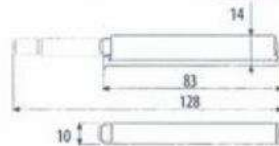

Index: AM-PL-DL-MAG

Index: AM-ZAT-A1-10

