

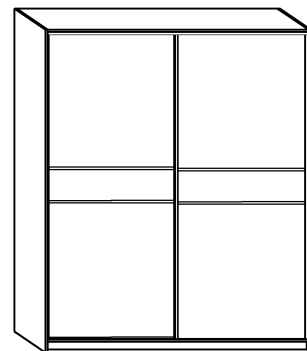











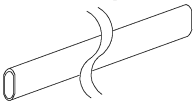





PUERTO 200B

→ 200 ↑ 216 ↘ 65



x 28  (a)	x 15  (b)	x 2  (c)	x 2  (d)
x 2 (1174 mm)  (e)	x 4  (f)	x 6  (g)	x 2  (h)
x 4  (j)	x 4  (k)	x 4  (l)	 (i)
x 40 (3,5 x 13)  (m)	x 8 (6,2 x 13)  (n)	x 150  (o)	x 1  (p)

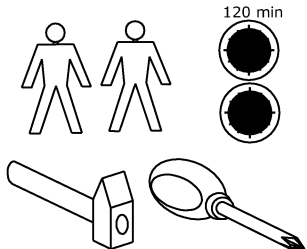

1 - FAZY MONTAŻU

A - OZNACZENIE ELEMENTÓW

a - OZNACZENIE AKCESORIÓW

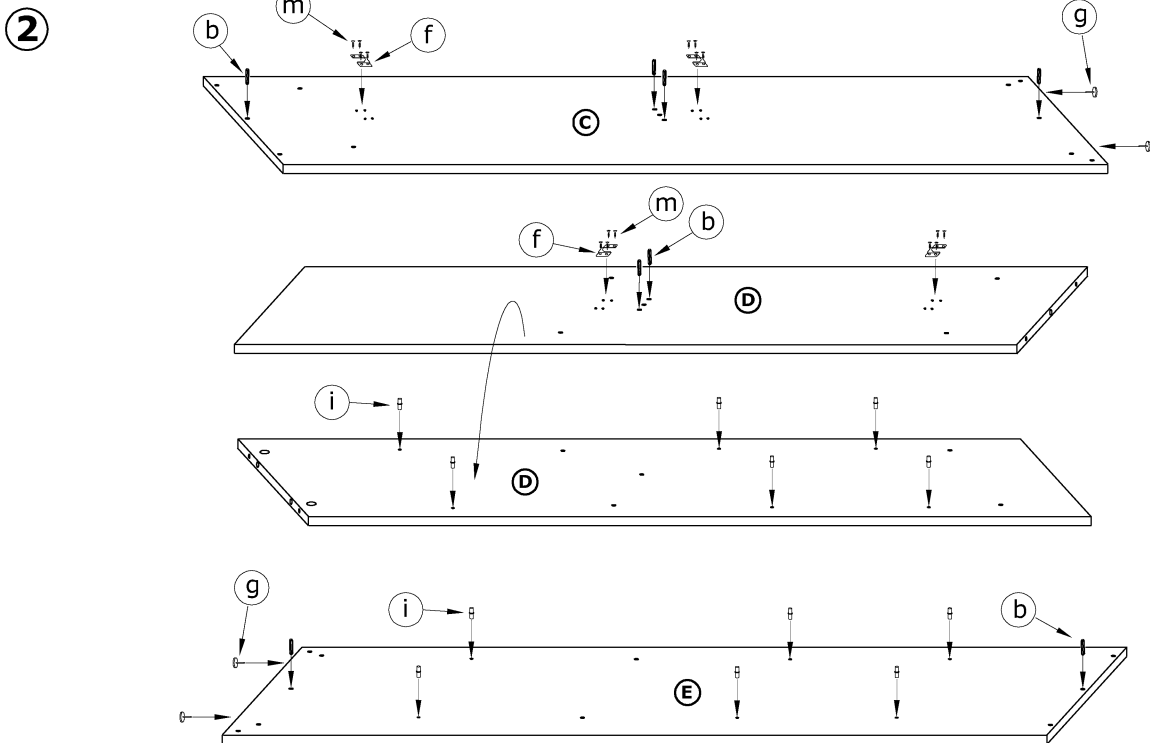
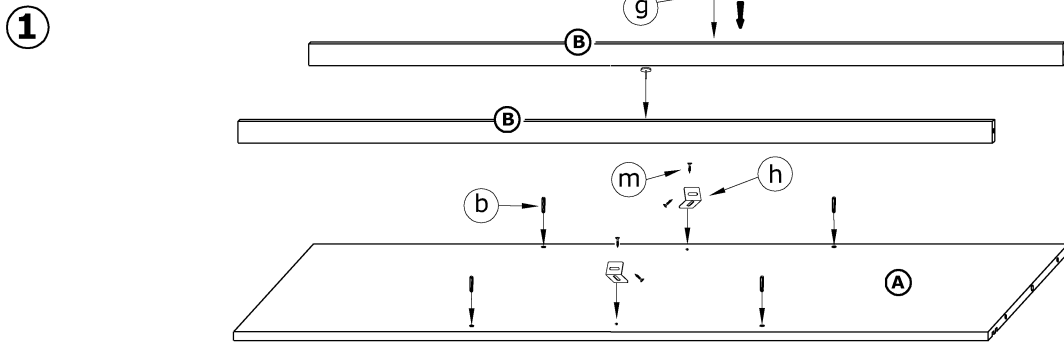

3

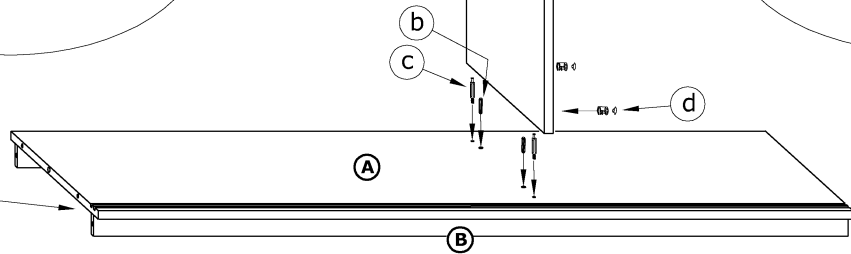
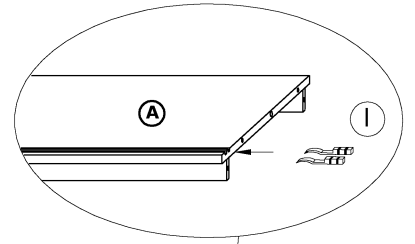
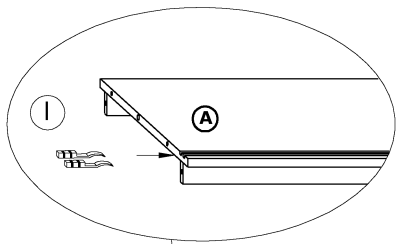
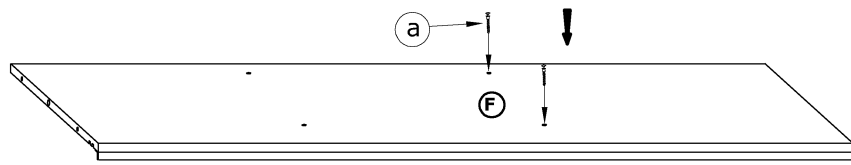

4

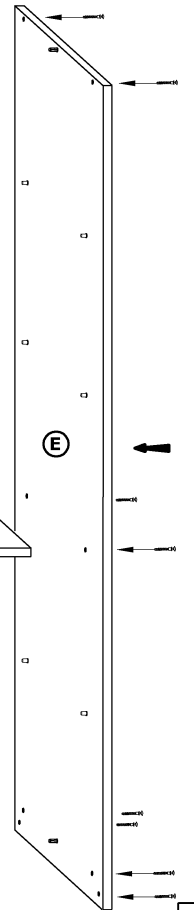
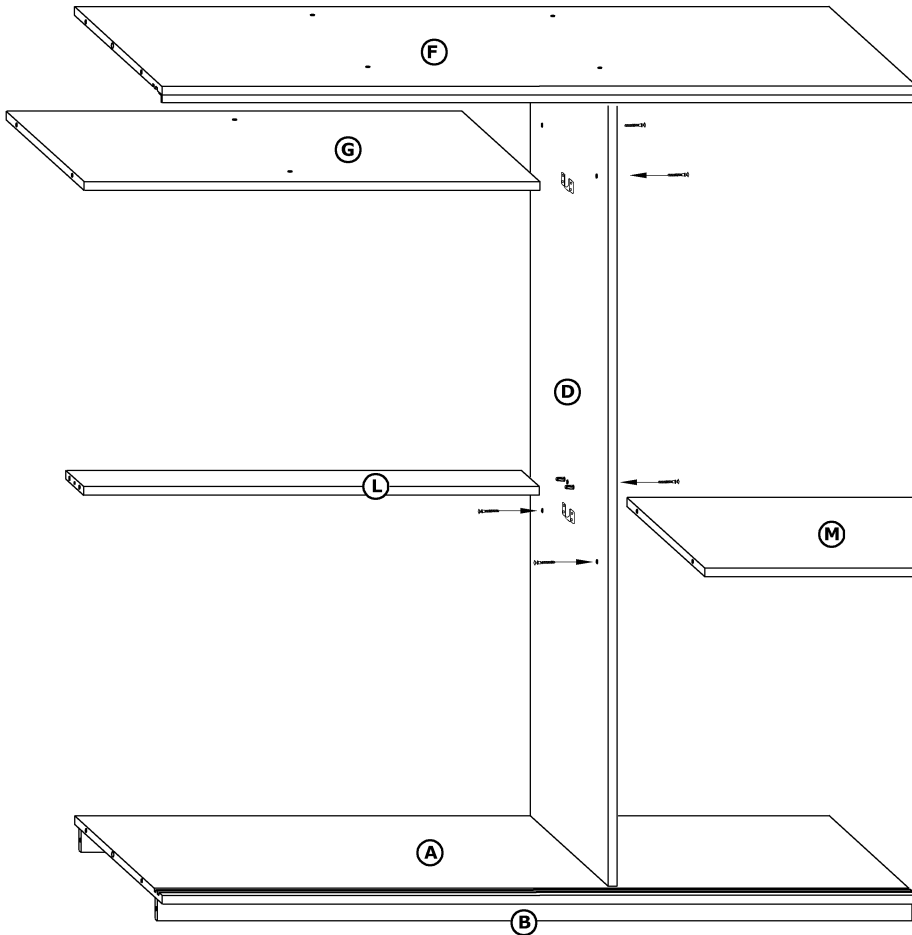
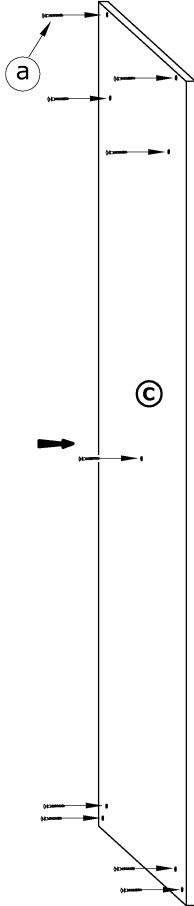

5

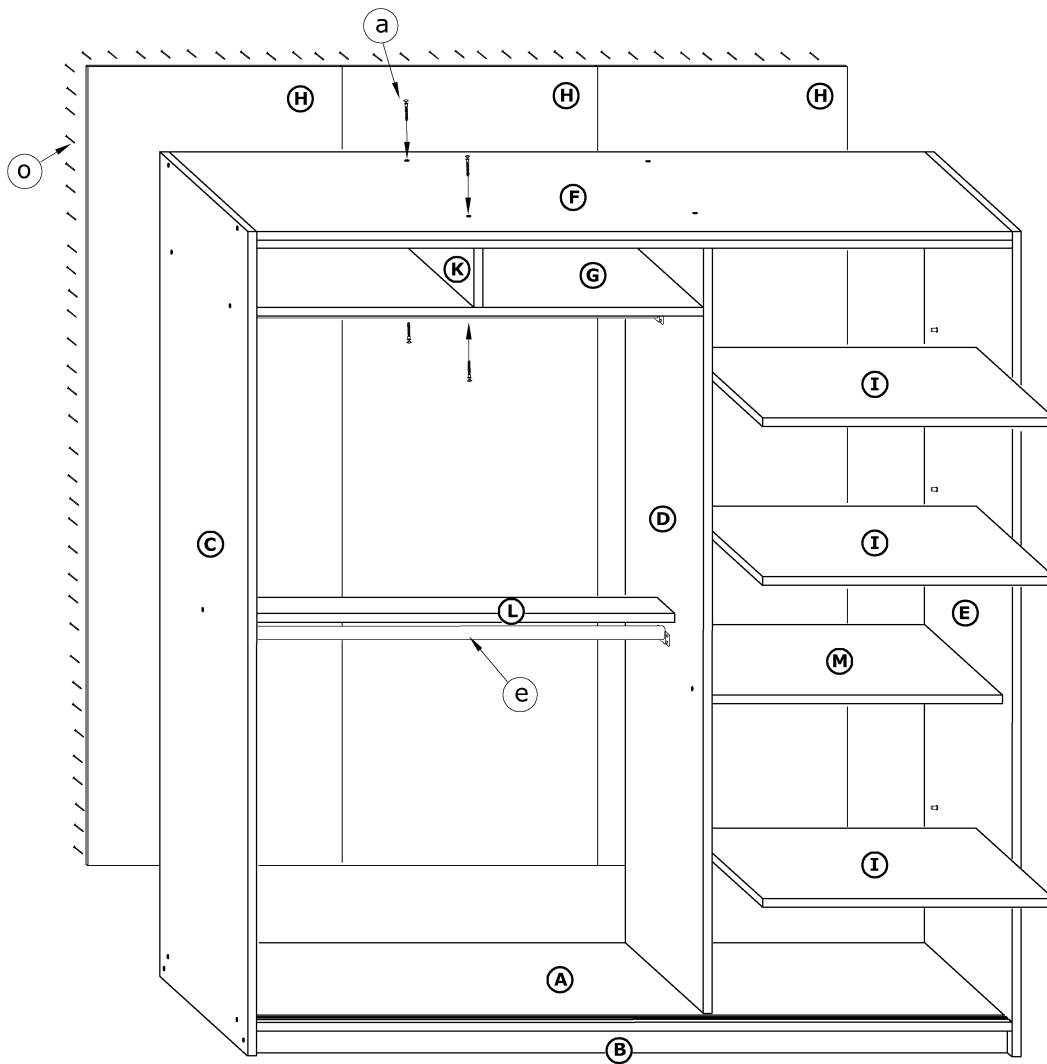

6

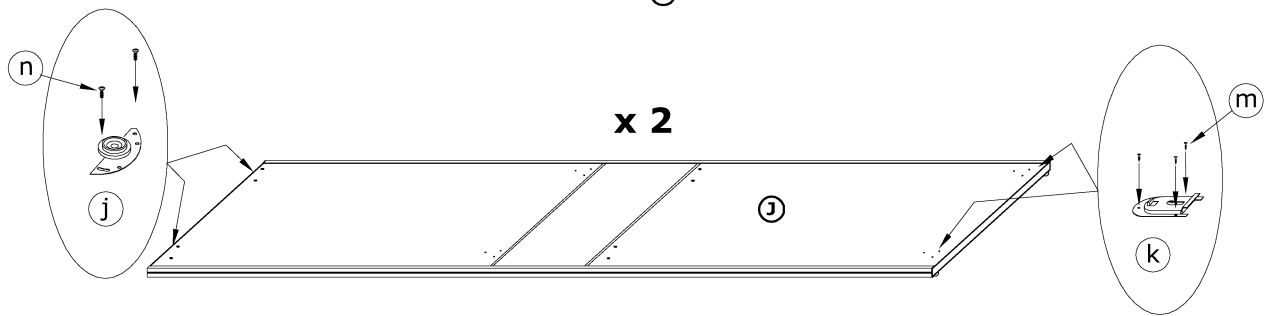

7

