

TOSCANIA MAX I

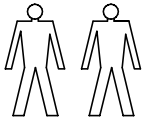

A

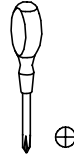
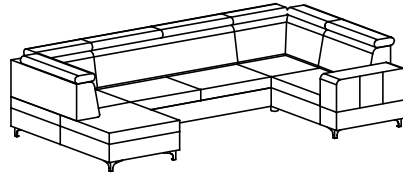
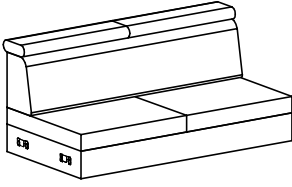

x1

B

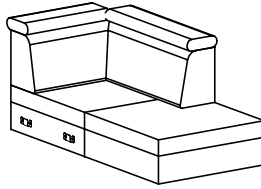

x1

C

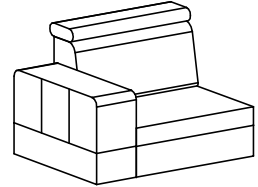

x1

D

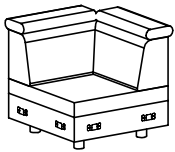

x1

E

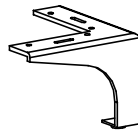

x8

F

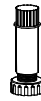

x1

G

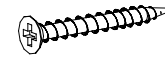

x40

H



x2

1

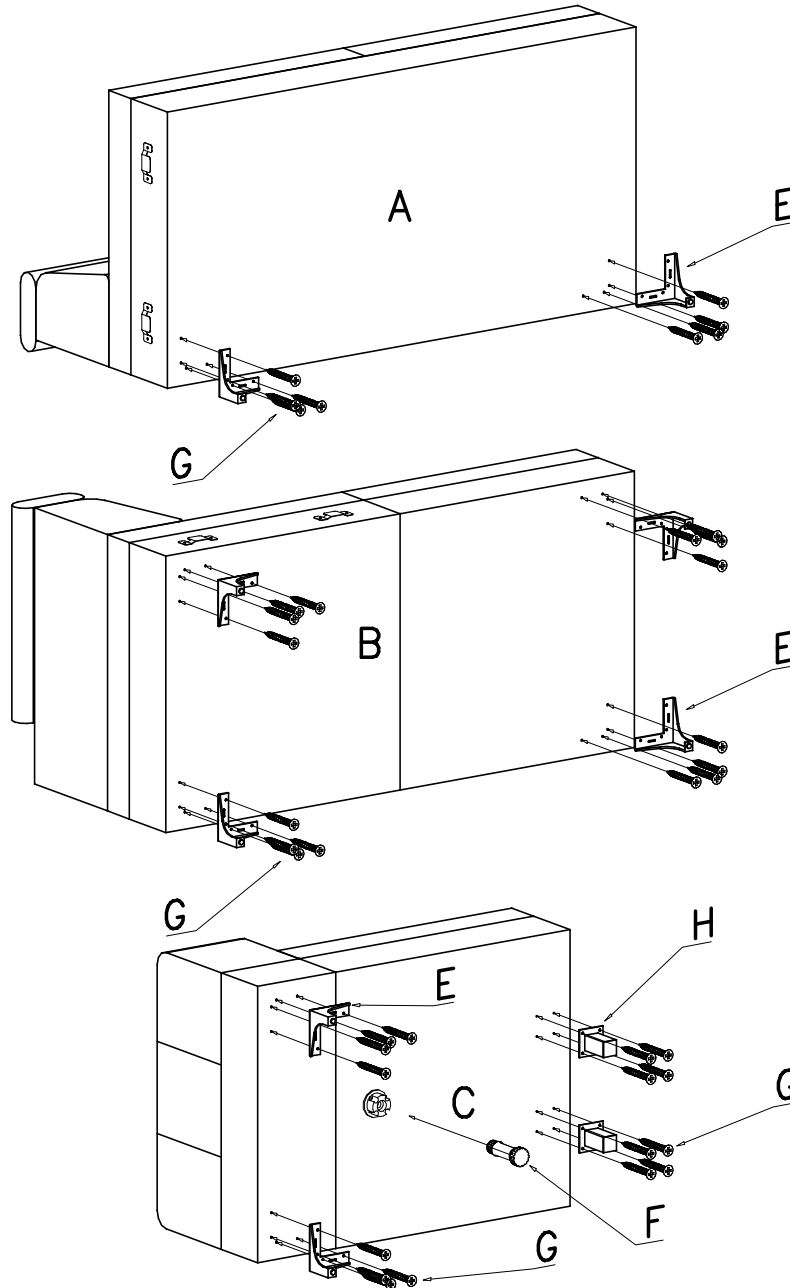

2

