

BR 119 S115 W75 G55

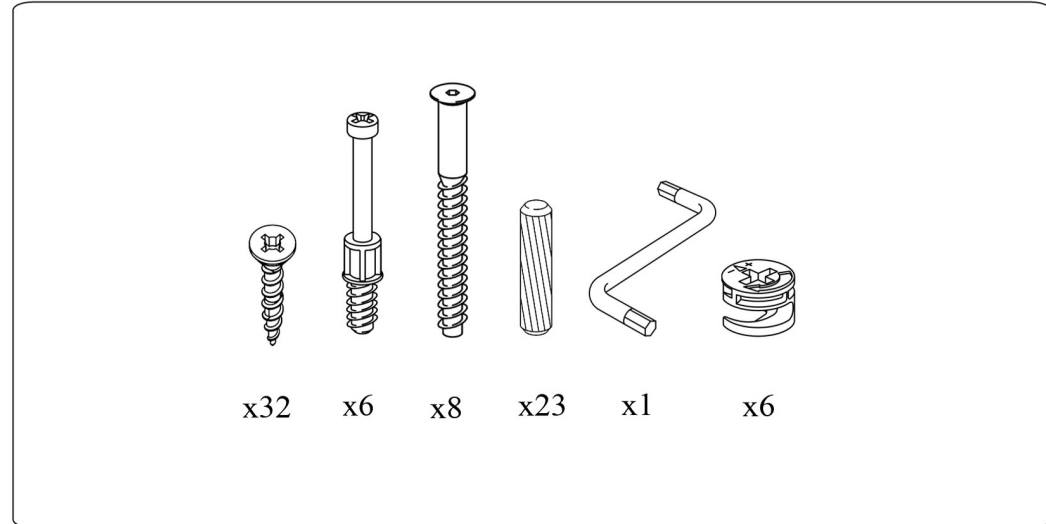

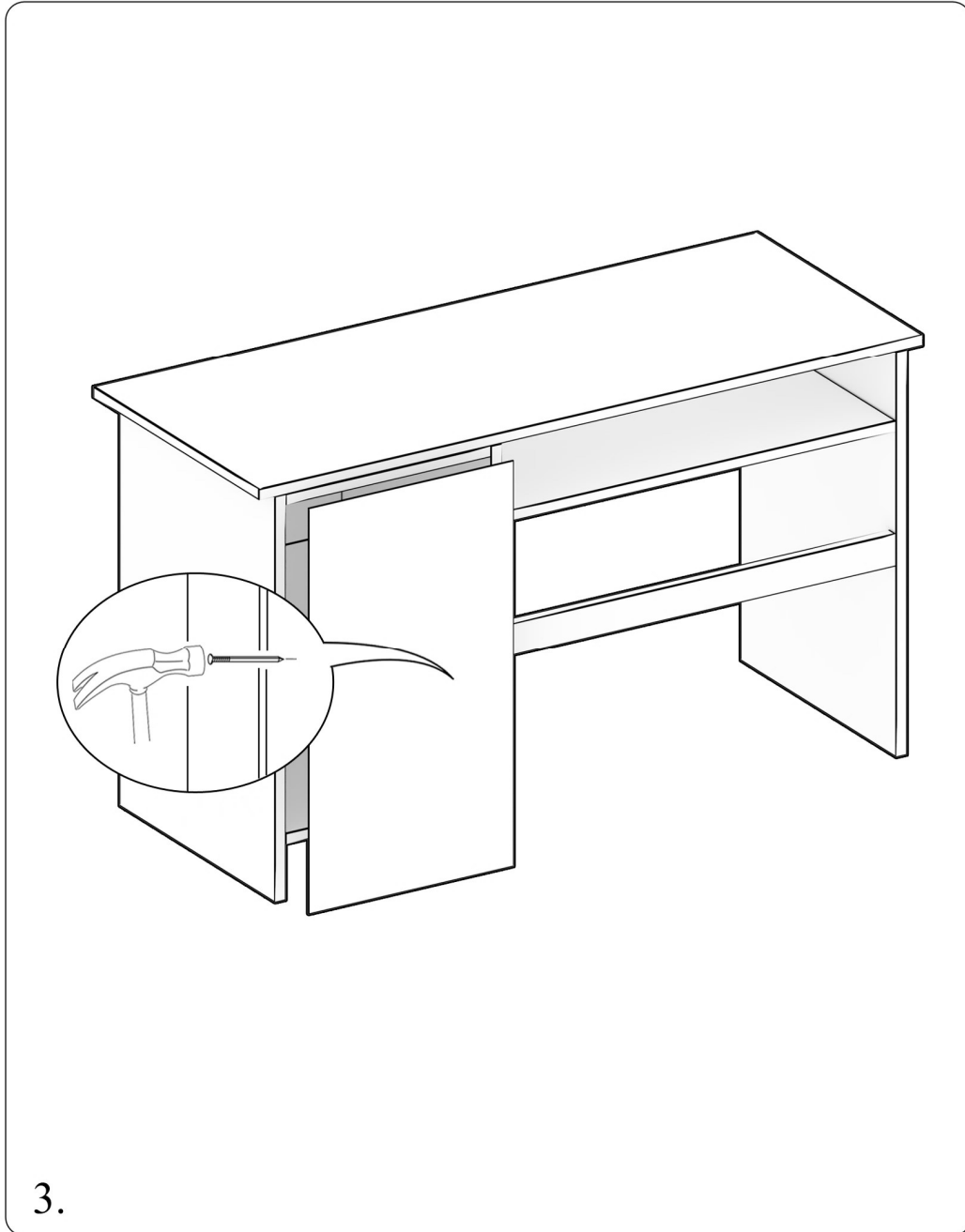

SZUFLADA

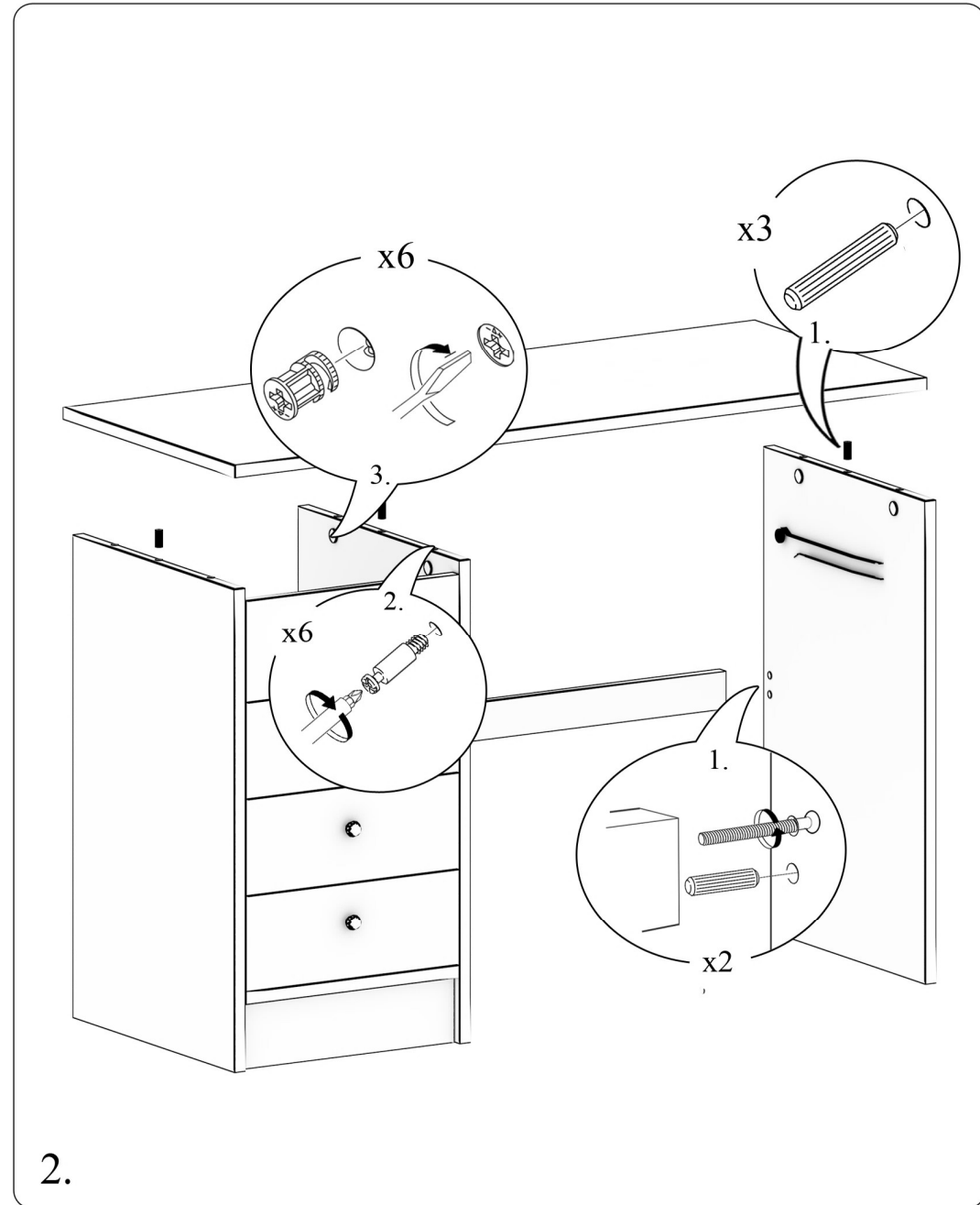
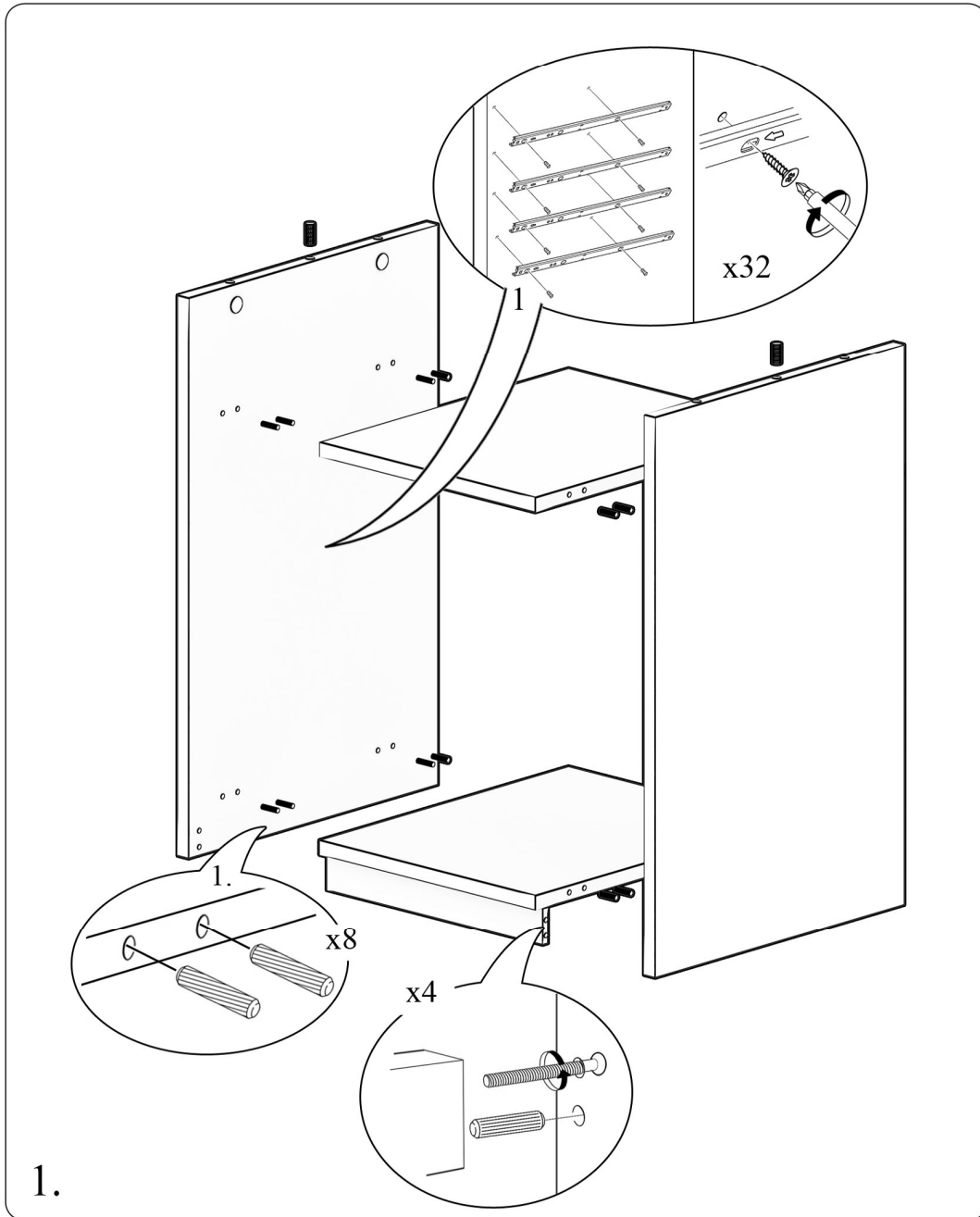