

COFFEE TABLES COMBO (90x50x49,3cm)

ŁAWA COMBO (90x50x49,3cm)

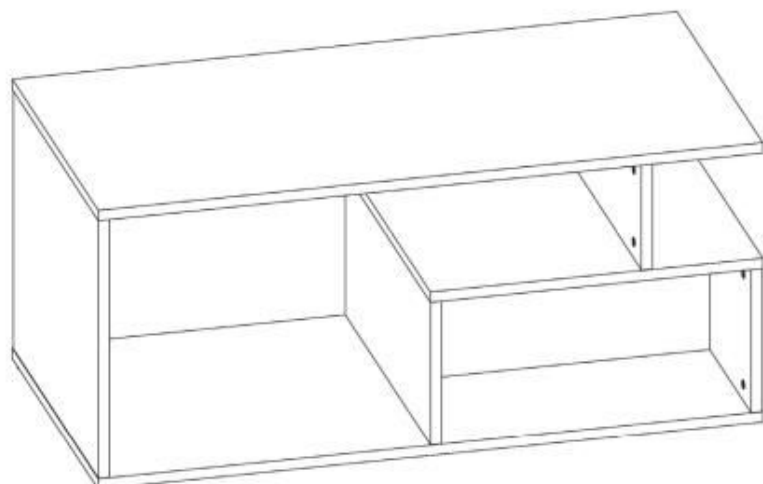

HALMAR Sp. z o.o., ul. Centralnego Okręgu Przemysłowego 2,
37-450 Stalowa Wola, POLSKA / POLAND
tel. +48 15 843 28 10, fax: +48 15 842 19 57,
e-mail: office@halmar.com.pl





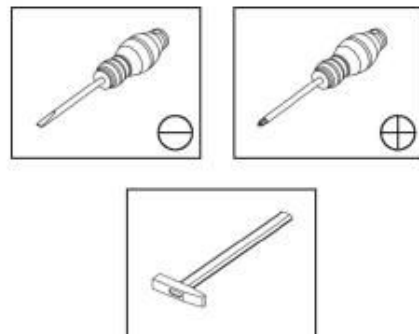

Potrzebne narzędzia Tools required

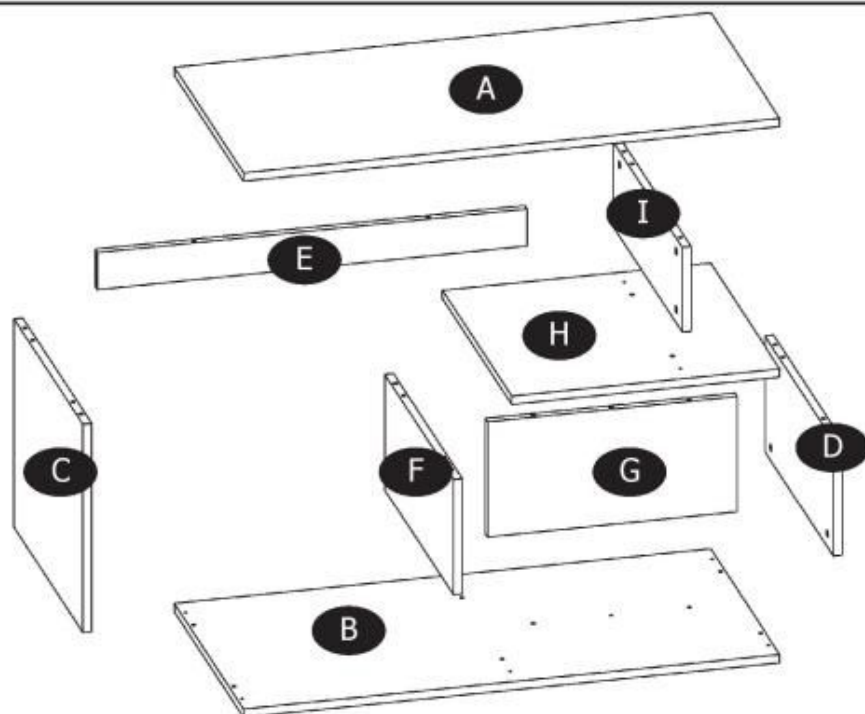

Elementy znajdujące się w opakowaniach/ Other elements

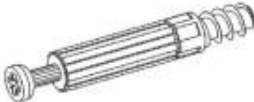

Okucia znajdujące się w opakowaniu/ Parts in the packaging

 20x	 20x	 $\Phi 8 \times 35 \text{mm}$ 24x
 4x	 20x	

1

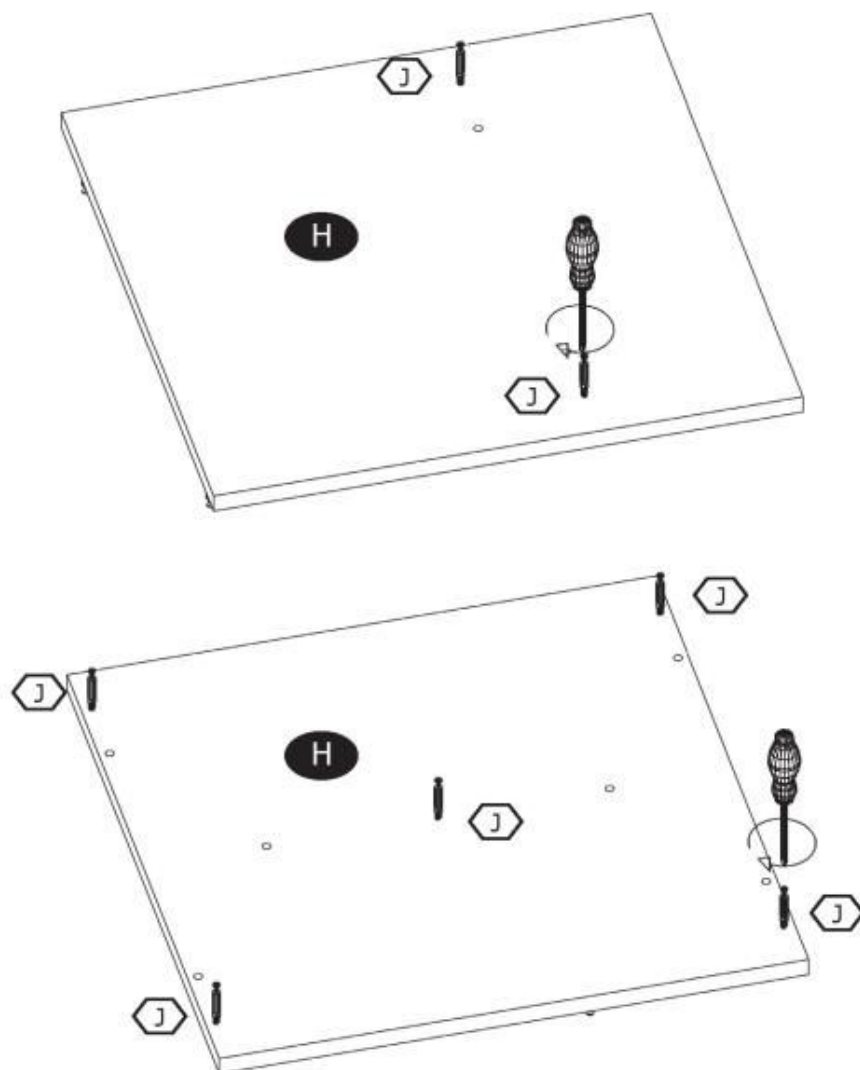

2

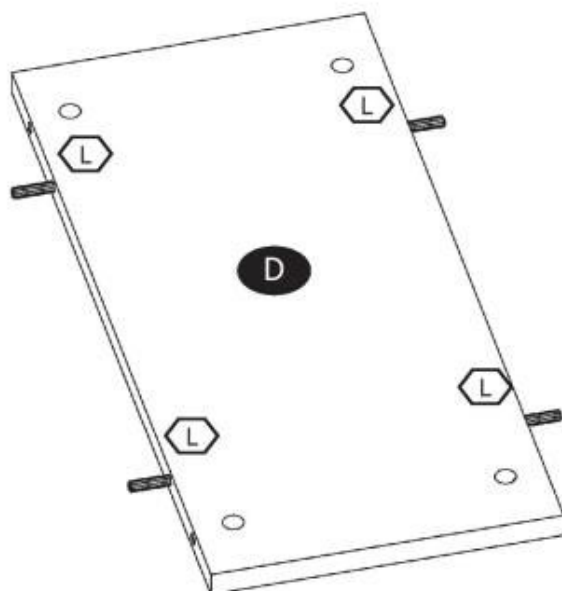
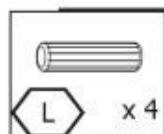

3

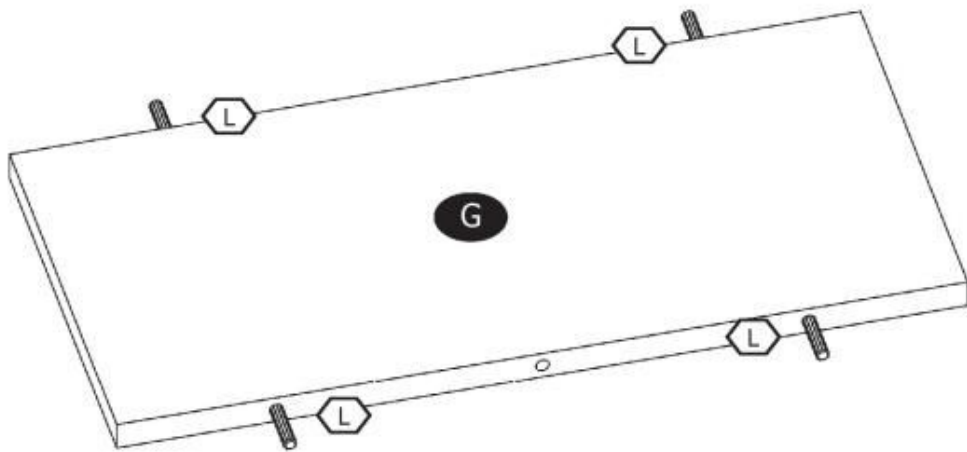
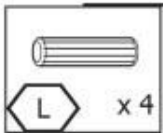
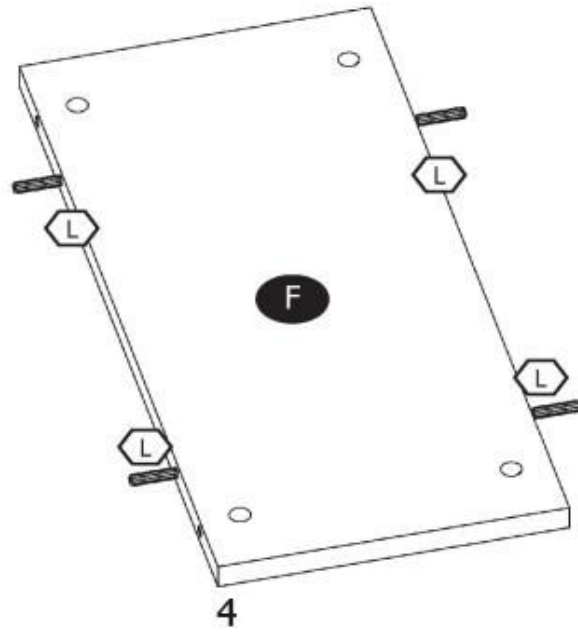
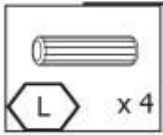

5

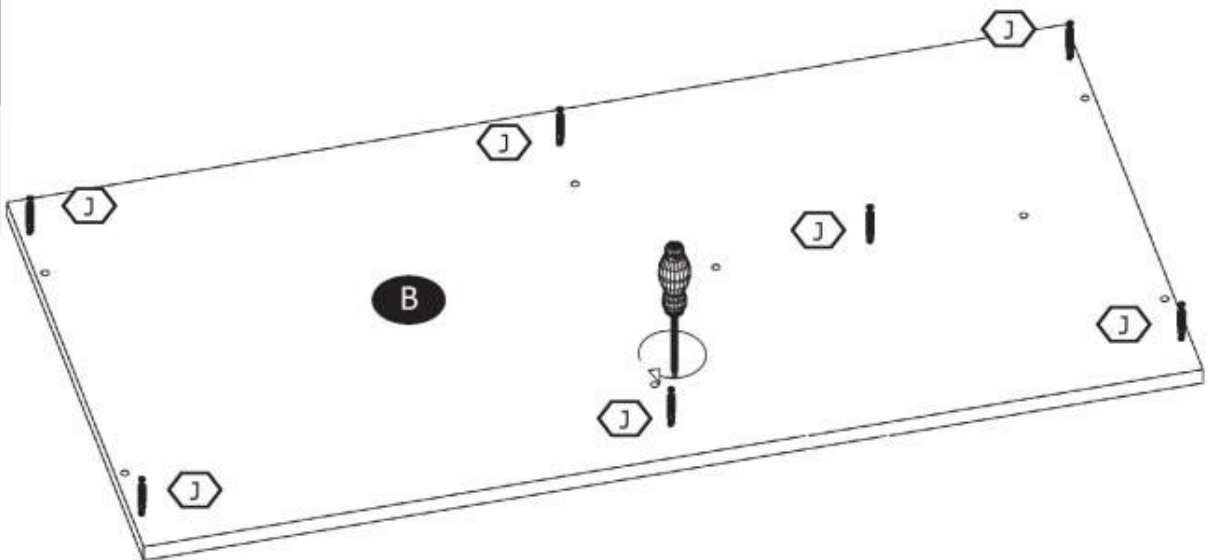

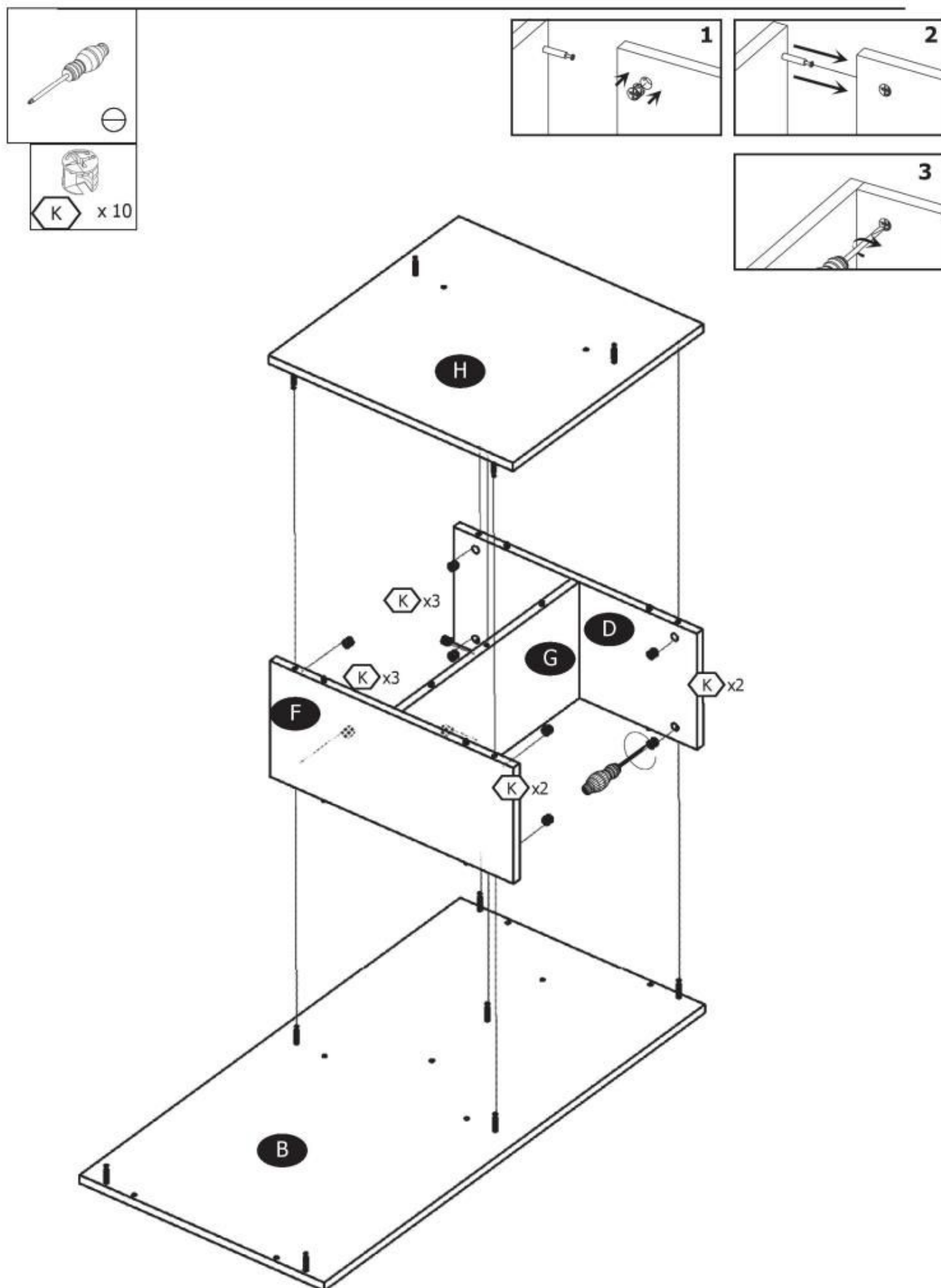

7

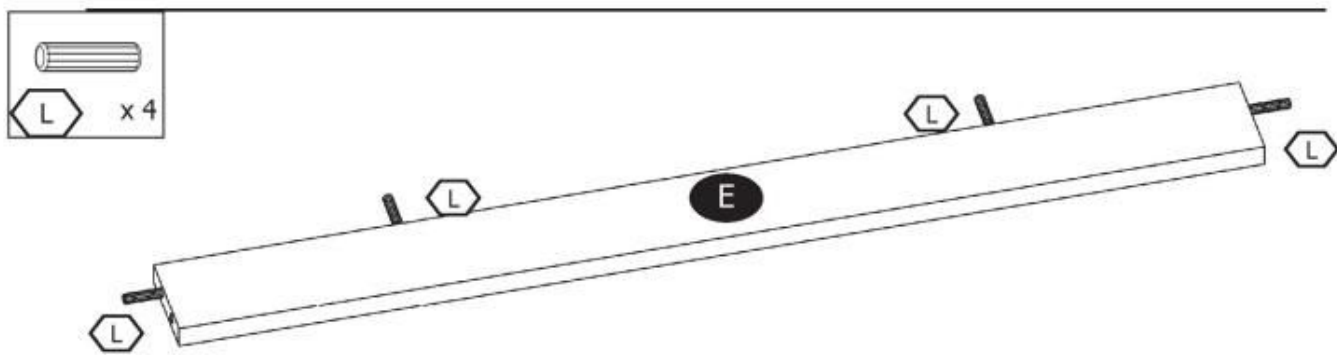

8

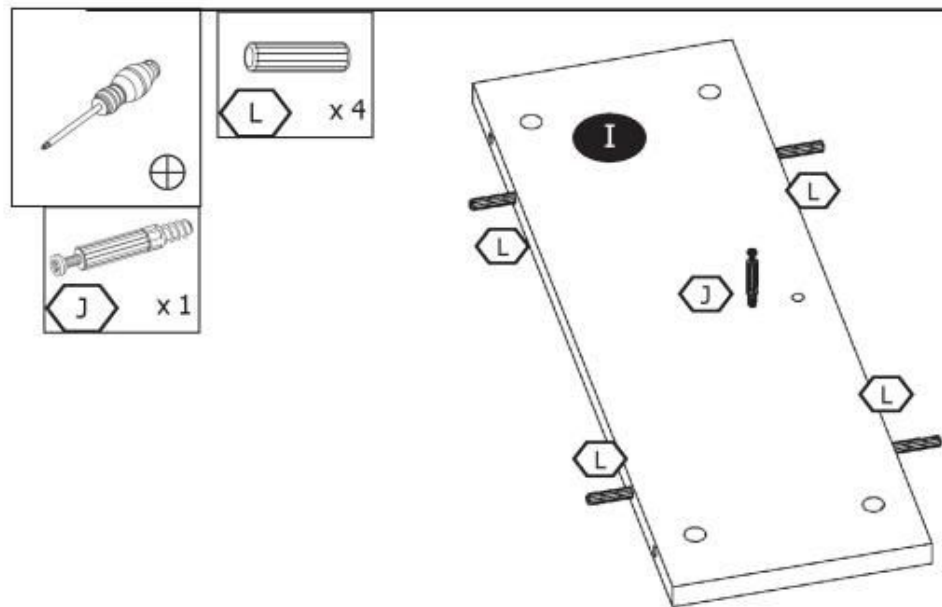

9

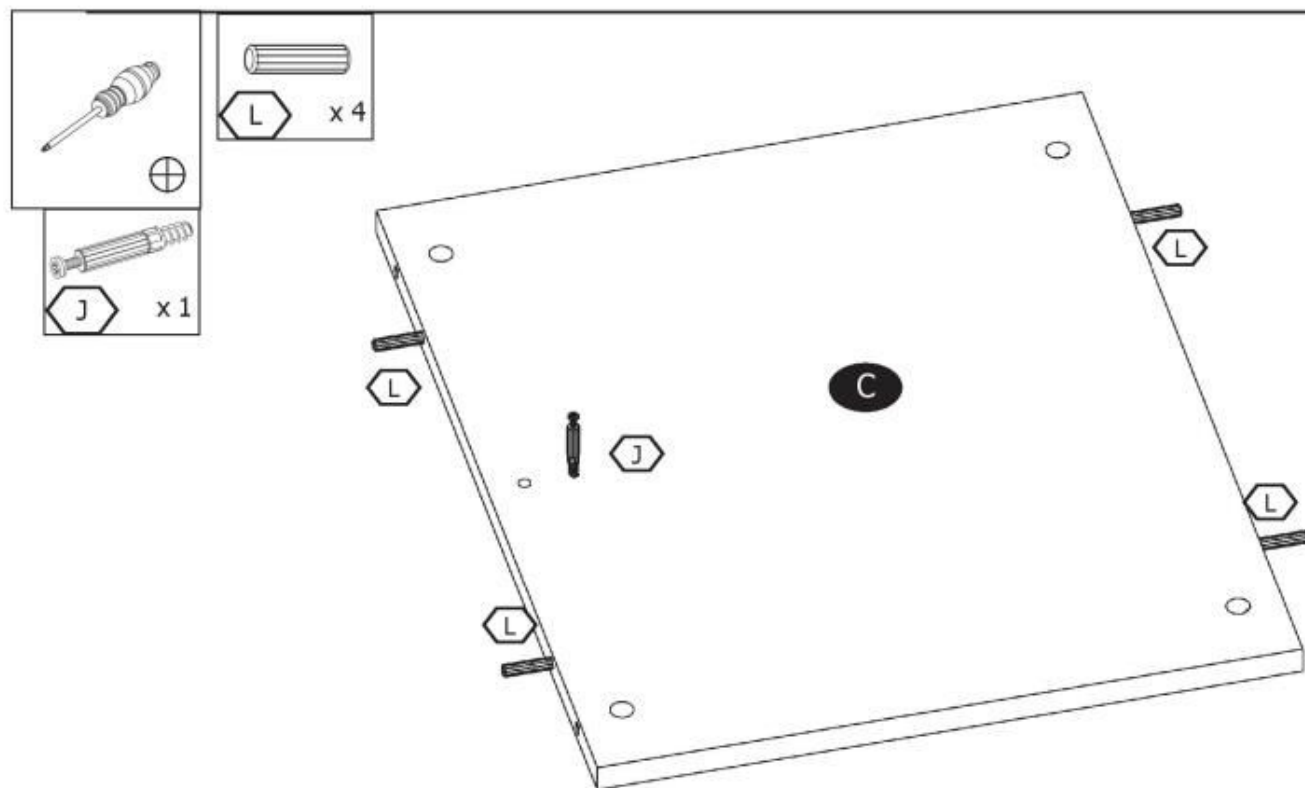

10

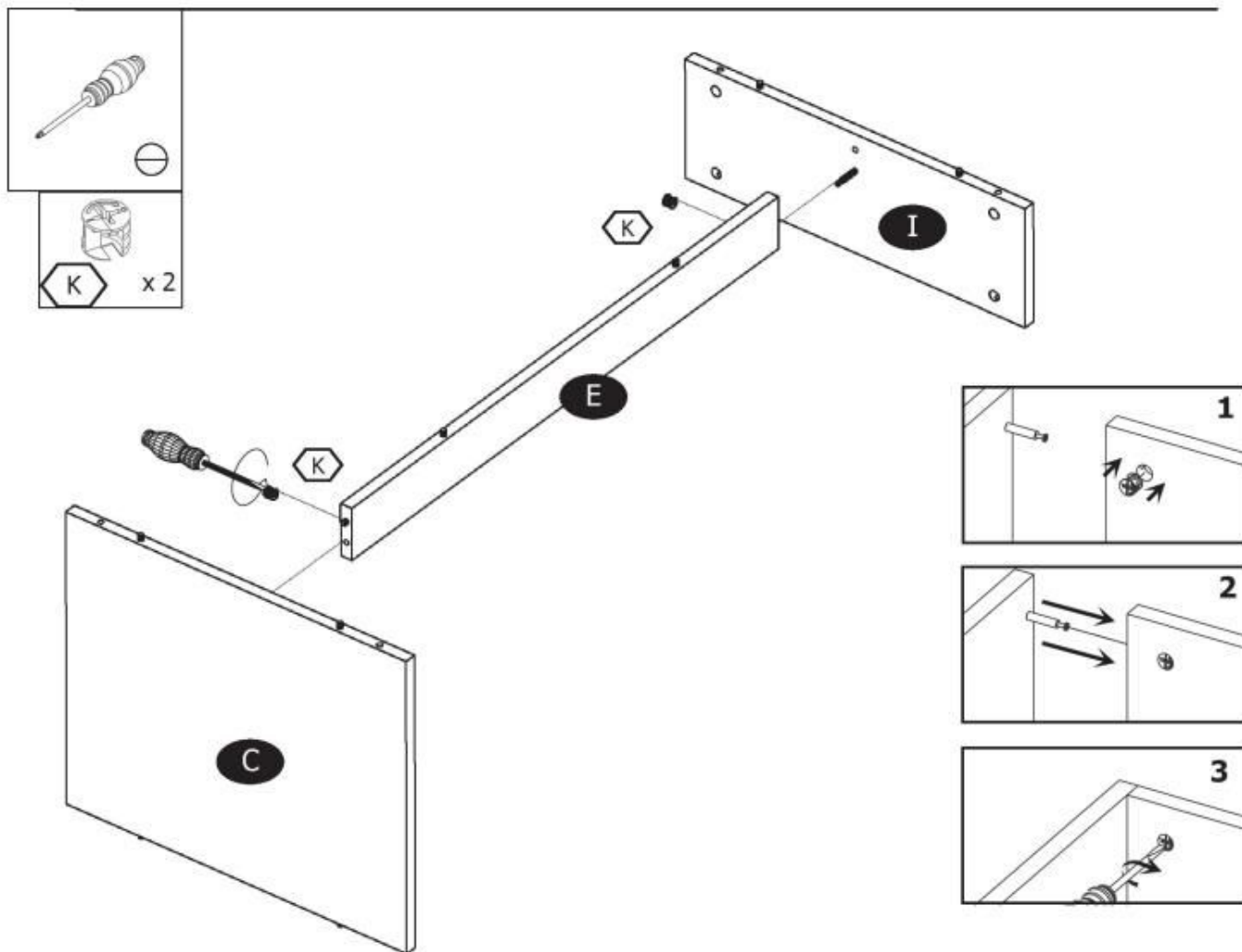

11

