

















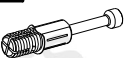
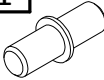
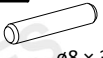
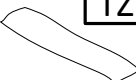



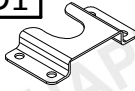
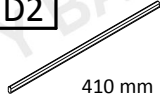
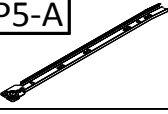

HAPPY SZ06-B

INSTRUKCJA MONTAŻU ASSEMBLY INSTRUCTIONS

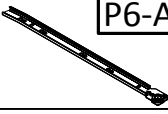
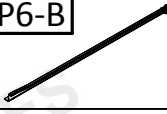
Akcesoria / Fittings

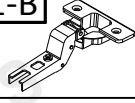
W1  Ø3 × 16 12 szt. / pcs	ZM1  8 szt. / pcs	W3  Ø3,5 × 16 12 szt. / pcs	W4  Ø4 × 16 51 szt. / pcs	W5  Ø4 × 35 1 szt. / pcs	W6  Ø6.3 × 50 32 szt. / pcs	G1  36 szt. / pcs	
M1  8 szt. / pcs	M2  8 szt. / pcs	B1  12 szt. / pcs	K1  Ø8 × 35 8 szt. / pcs	TZ1  1 szt. / pcs	S1  4 szt. / pcs	T1  11 szt. / pcs	
ZW1  32 szt. / pcs	N1  4 szt. / pcs	N2  4 szt. / pcs	U1  6 szt. / pcs	U2  Ø4 × 30 6 szt. / pcs	D1  2 szt. / pcs	D2  410 mm 1 szt. / pcs	
P5-A  2 szt. / pcs	P5-B  2 szt. / pcs	P6-A  2 szt. / pcs	P6-B  2 szt. / pcs	Z1-A  6 szt. / pcs	Z1-B  6 szt. / pcs		
Q1  1 szt. / pcs	Q2  1 szt. / pcs						

Narzędzia / Tools



**DO MONTAŻU POTRZEBNE SĄ DWIE OSOBY!
INSTALLATION REQUIRES TWO PEOPLE!**

BARDZO WAŻNE!
NALEŻY UWAŻNIE PRZECZYTAĆ
ZACHOWAĆ DO PÓŹNIEJSZEGO STOSOWANIA

INSTRUKCJA OBSŁUGI

1.

By zapobiec zadławieniu lub uduszeniu opakowanie z akcesoriami należy trzymać w miejscu niedostępnym dla niemowląt i dzieci.

2.

Wszystkie połączenia w meblu muszą być dobrze dokręcone, żaden z elementów łączących nie może być luźny.

3.

Nie należy używać szafy jeśli jakikolwiek element jest uszkodzony lub brakuje elementu.

4.

Należy używać tylko elementów dopuszczonych przez producenta.

5.

Nie należy w pobliżu szafy umieszczać otwartych źródeł ognia oraz innych silnych źródeł ciepła, jak promienniki gazowe lub elektryczne itp., gdyż grozi to pożarem.

6.

Szafę należy przytwierdzić do ściany za pomocą dołączonej taśmy zabezpieczającej!

VERY IMPORTANT!
PLEASE READ CAREFULLY
SAVE FOR FUTURE USE
USER'S MANUAL

1.

To avoid the danger of choking or strangulation keep the package with fittings away from babies and children.

2.

All connections must be tightened properly and no coupled element can not be loose.

3.

Do not use the wardrobe when, if any of the elements is damaged or if there is any element missing.

4.

Use only the elements given by manufacturer.

5.

Do not place the wardrobe near naked flames or other heat sources such as electric or gas radiators etc., this may cause a fire.

6.

The wardrobe must be fixed to the wall using the supplied roll-over protection tape!

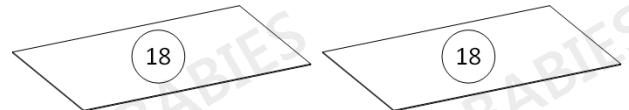
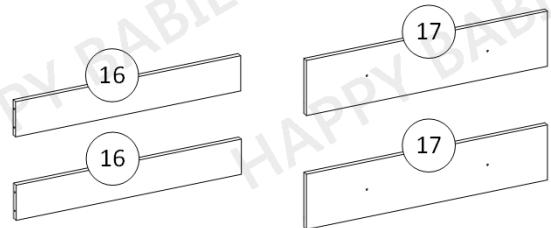
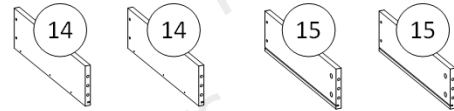
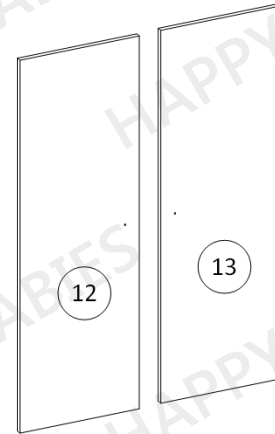
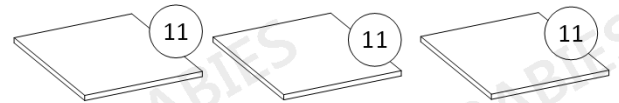
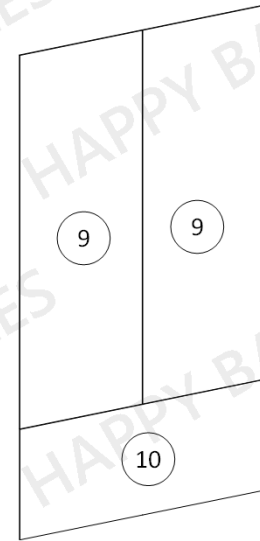
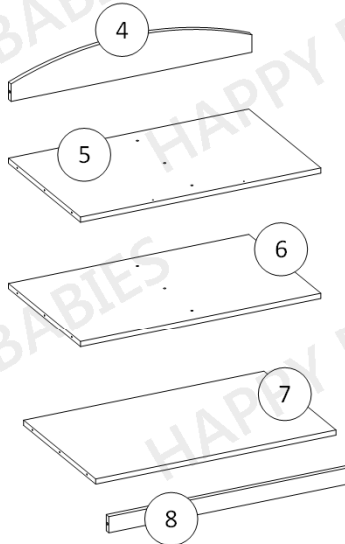
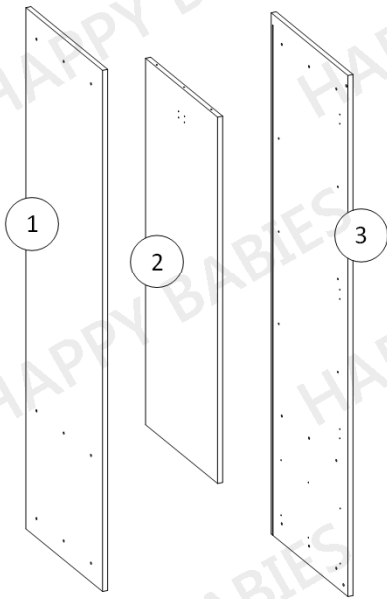

Paczka 1 z 2 / Package 1 of 2		
Numer elementu / Item no.	Wymiary (mm) / Dimensions (mm)	Ilość / Quantity
1	1800 x 540 x 18	1
2	1266 x 507 x 18	1
3	1800 x 540 x 18	1
9	431 x 1292 x 3	2
10	864 x 380 x 3	1
12	420 x 1290 x 18	1
13	420 x 1290 x 18	1
14	500 X 138 X 18	1
Paczka 2 z 2 / Package 2 of 2		
Numer elementu / Item no.	Wymiary (mm) / Dimensions (mm)	Ilość / Quantity
4	846 x 140 x 18	1
5	846 x 507 x 18	1
6	846 x 507 x 18	1
7	846 x 507 x 18	1
8	846 x 56 x 18	1
11	414 x 497 x 18	3
14	500 x 138 x 18	1
15	500 x 138 x 18	2
16	785 x 120 x 18	2
17	842 x 188 x 18	2
18	803 x 504 x 3	2

PRZED MONTAŻEM MEBLA NALEŻY DOKŁADNIE SPRAWDZIĆ CZY PACZKI ZAWIERAJĄ WSZYSTKIE ELEMENTY WYSZCZEGÓLNIONE W TABELCE NA STRONIE 3 ORAZ CZY ELEMENTY TE NIE SĄ USZKODZONE !!!
JEŚLI BRAKUJE ELEMENTÓW LUB NIEKTÓRE Z NICH SĄ USZKODZONE PROSIMY O KONTAKT Z NASZYM BIUREM OBSŁUGI KLIENTA.
USZKODZENIA ELEMENTÓW STWIERDZONE JUŻ PO MONTAŻU MEBLA NIE BĘDĄ UWZGLĘDNIANE !!!

BEFORE ASSEMBLING THE FURNITURE PLEASE CHECK THAT PACKAGES INCLUDE ALL ITEMS LISTED IN THE TABLE ON PAGE NO 3,
AND WHETHER THESE ITEMS ARE NOT DAMAGED !!!
IF MISSING PARTS OR SOME OF THEM ARE DAMAGED, PLEASE CONTACT OUR CUSTOMER SERVICE OFFICE.
DAMAGES FOUND AFTER ASSEMBLING WILL NOT BE CONSIDERED !!!

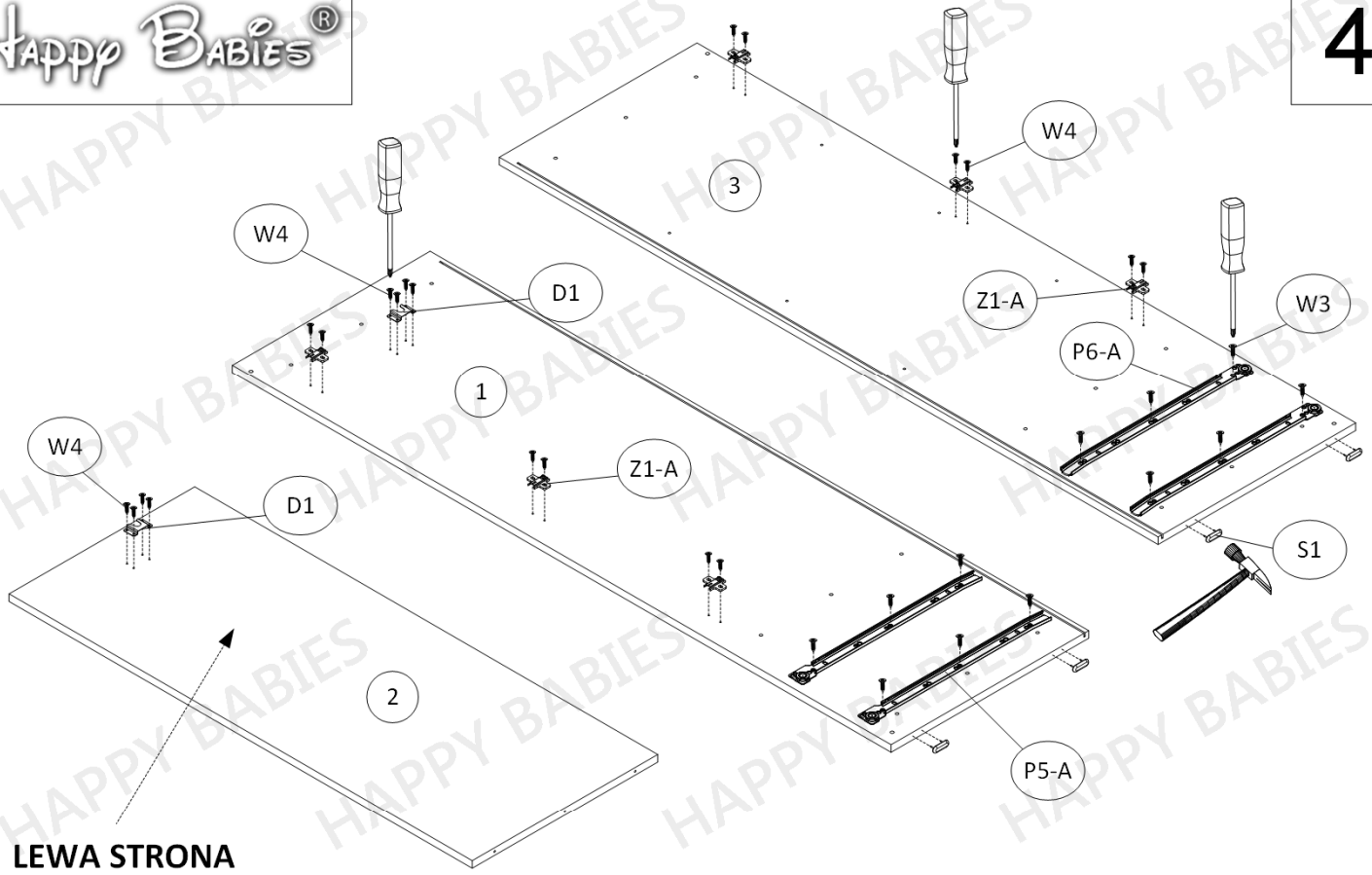

**LEWA STRONA
LEFT SIDE**

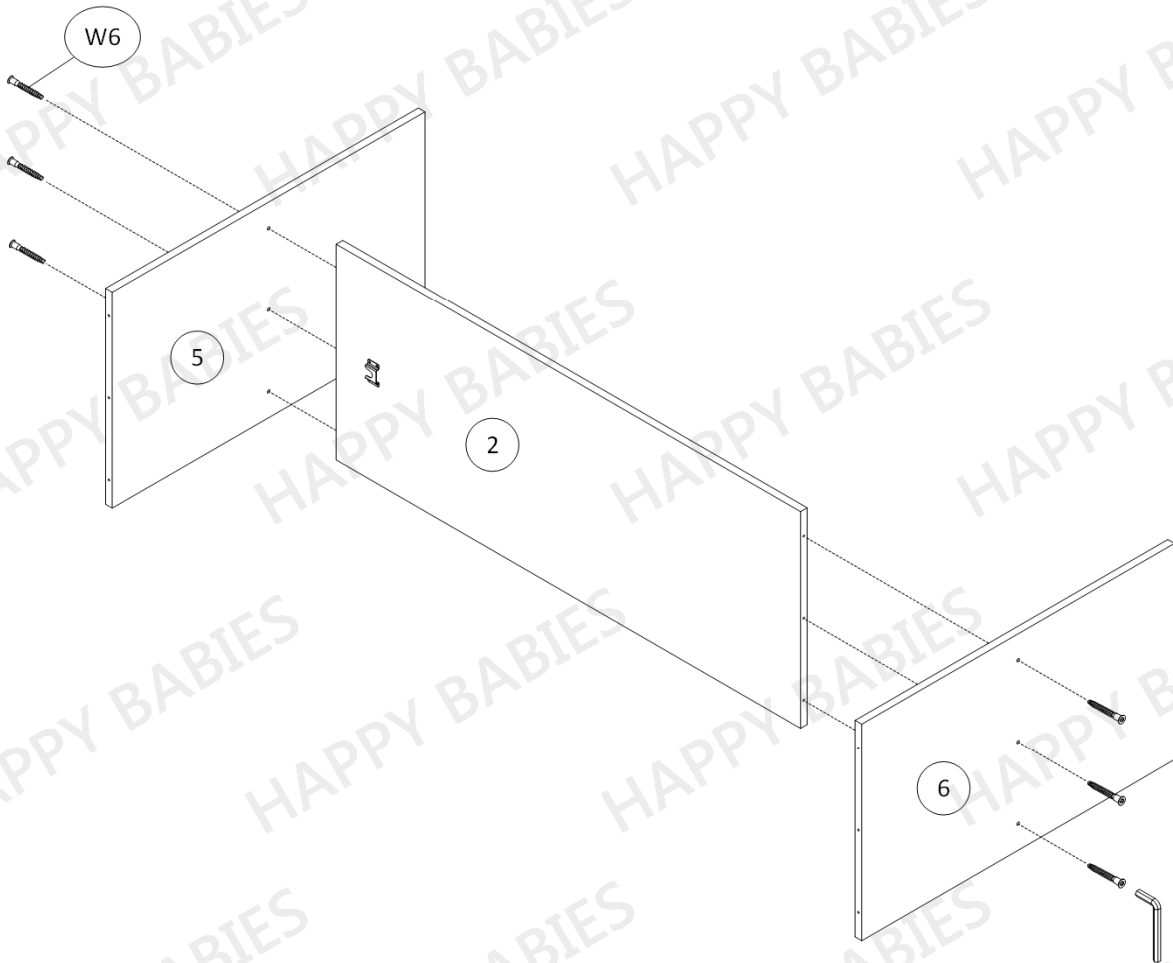

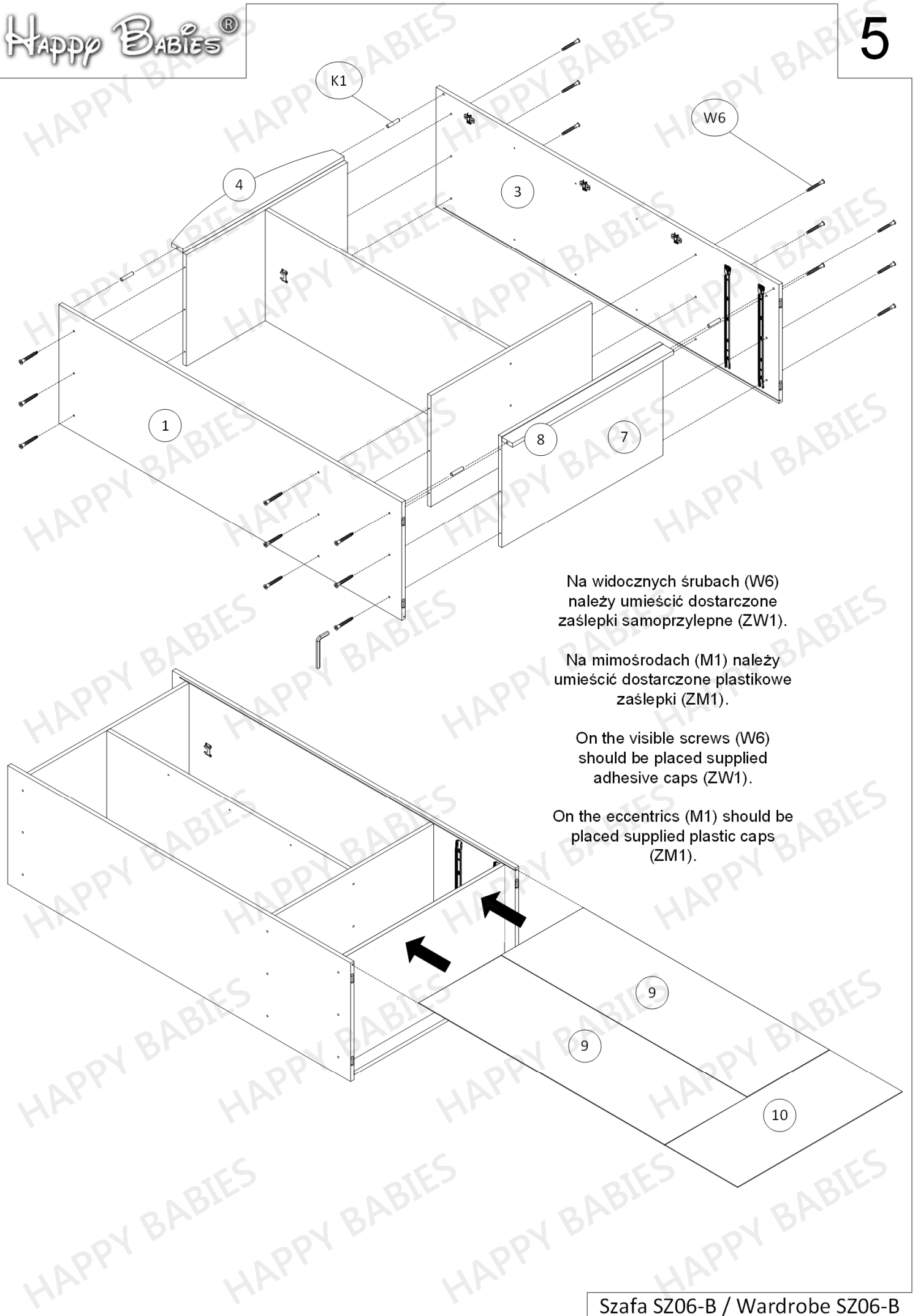

Na widocznych śrubach (W6) należy umieścić dostarczone zaślepki samoprzylepne (ZW1).

Na mimośrodkach (M1) należy umieścić dostarczone plastikowe zaślepki (ZM1).

On the visible screws (W6) should be placed supplied adhesive caps (ZW1).

On the eccentrics (M1) should be placed supplied plastic caps (ZM1).

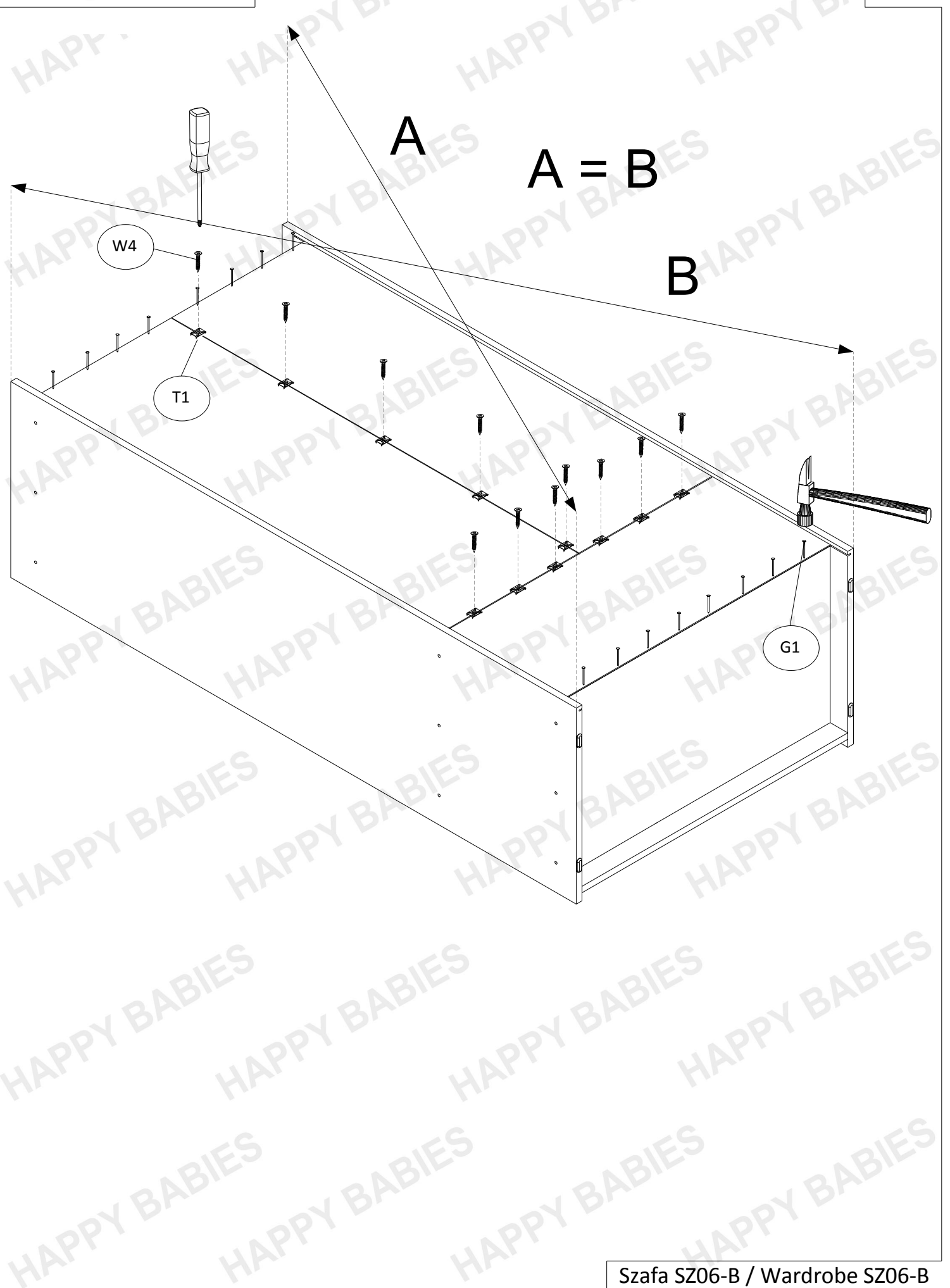

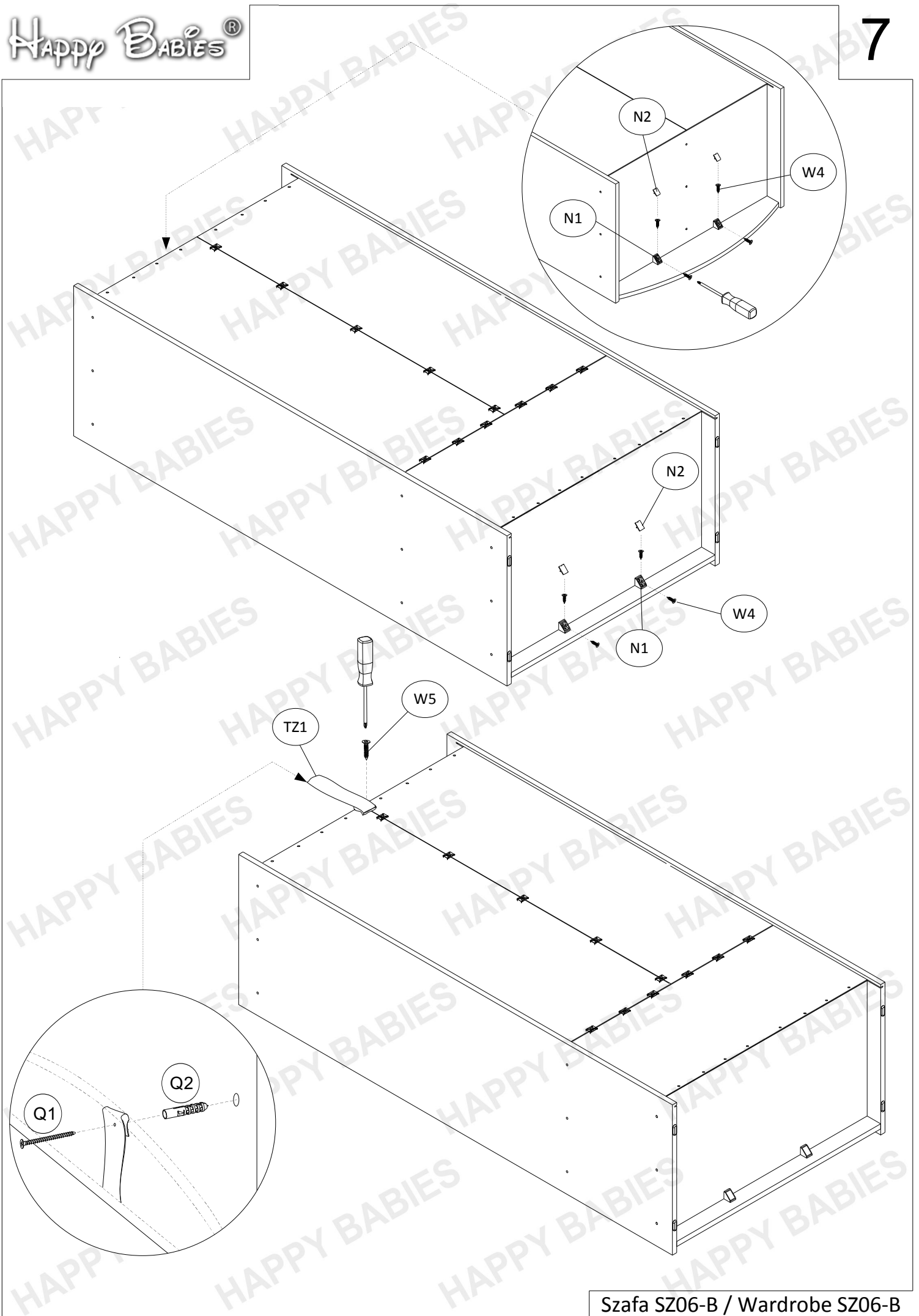

Szafa SZ06-B / Wardrobe SZ06-B

