

- PL Instrukcja montażu
 D Montageanleitung
 NL Handleiding voor de montage
 TR Montaj talimatı
 F Notice de montage
 CZ Montážní návod
 HU Szerelési útmutató
 GB Assembly instructions
 RU Инструкция по монтажу
 IT Istruzioni di montaggio
 SK Návod na montáž
 RO Instrucțiuni de montaj
 ES Instrucciones de montaje

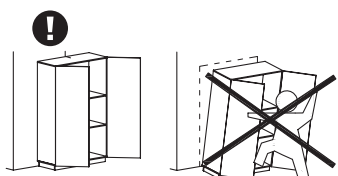

2022-05-05

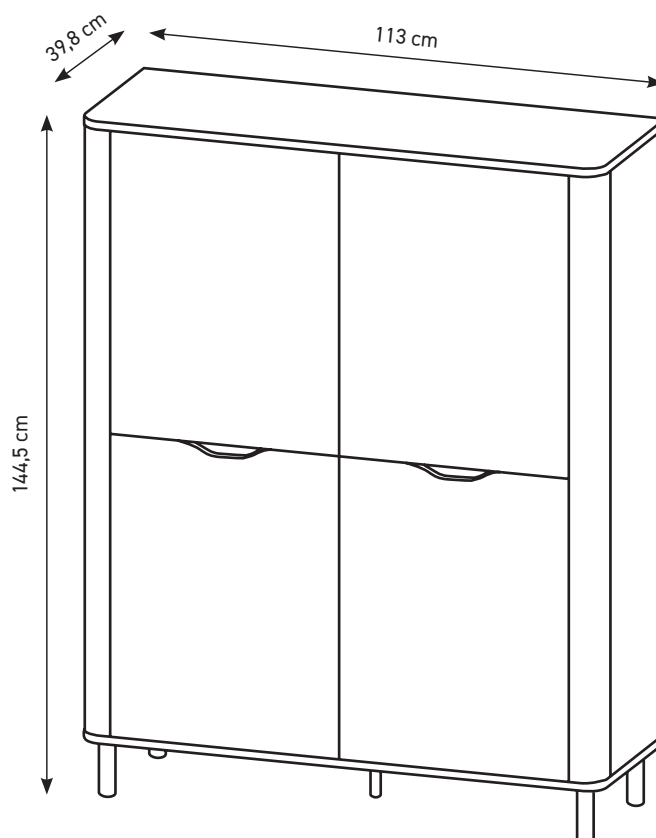

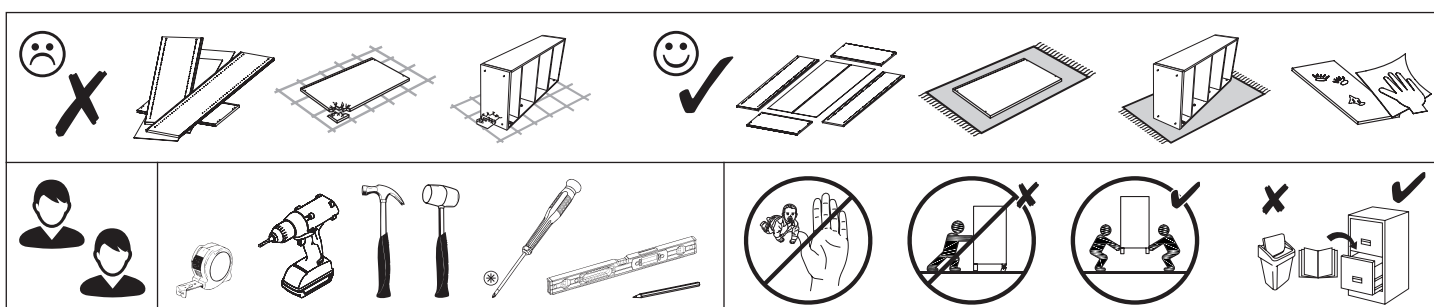

PL Przed rozpoczęciem montażu mebla wszystkie elementy należy sprawdzić czy nie są uszkodzone. W przypadku wykrycia uszkodzenia elementu należy odstąpić od montażu mebla i złożyć reklamację. Montaż produktu w oparciu o uszkodzone elementy oznacza akceptację ich stanu przez Kupującego, co powoduje, że reklamacja uszkodzonych elementów nie będzie uznawana.

Nie wolno przekraczać podanych maksymalnych wartości obciążenia. W innym przypadku można mebel uszkodzić lub zniszczyć.

Przed zawieszeniem mebla, lub przymocowaniem go do ściany (w celu zabezpieczenia przed przewróceniem), sprawdź wcześniej rodzaj i wytrzymałość ściany. Dobierz odpowiednie kotki i wkręty do rodzaju ściany. W przypadku wątpliwości skontaktuj się ze specjalistą. Montaż musi zostać wykonany przez osobę kompetentną.

D Vor Beginn der Möbelmontage sollten alle Elemente auf Beschädigungen überprüft werden. Wenn ein Element des Produkts beschädigt ist, installieren Sie das Produkt bitte nicht und reichen Sie eine Beschwerde ein. Die Installation des Produkts auf der Grundlage der beschädigten Elemente bedeutet, dass der Käufer seinen Zustand akzeptiert, was bedeutet, dass die Beschwerde über beschädigte Elemente nicht akzeptiert wird.

Überschreiten Sie die angegebenen Maximalbelastungen nicht. Andernfalls kann das Möbelstück beschädigt oder zerstört werden.

Bevor Sie ein Möbelstück an einer Wand aufhängen oder befestigen (um es gegen Umkippen zu sichern), prüfen Sie Art und Tragfähigkeit der Wand. Wählen Sie für die Wand geeigneten Dübel und Schrauben. Im Zweifelsfall kontaktieren Sie bitte einen Fachmann. Die Montage muss durch eine sachkundige Person ausgeführt werden.

F Avant de commencer l'assemblage du meuble, tous les éléments doivent être vérifiés pour détecter tout dommage. Si un élément du produit est endommagé, veuillez ne pas installer le produit et déposer une plainte. L'installation du produit sur la base des éléments endommagés signifie que l'acheteur accepte leur état, ce qui signifie que la réclamation d'éléments endommagés ne sera pas acceptée.

Ne dépassez pas les charges maximum indiquées. Sinon, le meuble peut être endommagé ou détruit.

Avant de suspendre le meuble ou de le fixer au mur (dans le but d'éviter un renversement), vérifiez au préalable le type et la résistance du mur. Utilisez les chevilles et les vis adaptées au type de mur. En cas de doute, veuillez contacter un spécialiste. Le montage doit être réalisé par une personne compétente.

CZ Před zahájením montáže nábytku je třeba zkontrolovat poškození všech prvků. Pokud je některý prvek produktu poškozen, zdržte se instalace produktu a podejte stížnost. Instalace výrobku na základě poškozených prvků znamená, že kupující akceptuje jejich stav, což znamená, že reklamacie poškozených prvků nebude uznána. Nepřekračujte uvedené maximální zatížení. V opačném případě může dojít k poškození nebo zničení nábytku.

Před zavěšením nábytku nebo jeho připevněním ke zdi (za účelem zajištění před převrácením) dříve zkontrolujte druh a odolnost stěny. Vyberte k druhu stěny vhodné hmoždinky a šrouby. V případě pochybností kontaktujte specialistu. Montáž musí být provedena kompetentní osobou.

HU A bútor szerelés megkezdése előtt ellenőrizni kell az összes elem sérülését. Ha a termék bármely eleme megsérült, kérjük, tartózkodjon a termék telepítésétől és nyújtson be panaszt. A termék sérült elemek alapján történő felszerelés azt jelenti, hogy a Vevő elfogadja azok állapotát, ami azt jelenti, hogy a sérült elemek igényét nem fogadják el. A megadott maximális terhelési értékeket nem szabad túllépni. Ellenkező esetben a bútor megsérülhet vagy megsemmisülhet.

A bútor felfüggesztése illetve falhoz való rögzítése (megakadályozván ezzel eldőléseinek lehetőségét) előtt ellenőrizze a fal fajtáját és szilárdságát. Megfelelő, a falhoz illő tipliket és csavarokat használjon. Ha kétsége támadna, konzultáljon szakemberrel. A felszerelést csakis egy hozzáértő szakember végezheti el.

GB Before starting the furniture assembly, all elements should be checked for damage. If any element of the product is damaged, please refrain from installing the product and file a complaint. Installation of the product on the basis of the damaged elements means the Buyer's acceptance of their condition, which means that the complaint of damaged elements will not be accepted.

The specified maximum load values must not be exceeded. Otherwise, the piece of furniture may be damaged or destroyed.

Before suspending or fixing furniture to the wall (in order to prevent falling over), check the type and strength of the wall. Select wall plugs and screws appropriate for the given type of the wall. In the case of doubts, contact a specialist. The installation must be performed by a competent person.

SK Pred začatím montáže nábytku by sa mali skontrolovať všetky prvky, či nie sú poškodené. Ak je niektorý prvok výrobku poškodený, neinštalujte výrobok a reklamujte ho. Inštalácia produktu na základe poškodených prvkov znamená, že Kupujúci akceptuje ich stav, čo znamená, že reklamácia poškodených prvkov nebude akceptovaná. Uvedené hodnoty maximálneho zaťaženia nesmú byť prekročené. V opačnom prípade môže dôjsť k poškodeniu alebo zničeniu nábytku.

Pred zaviesním nábytku alebo jeho pripavením na stenu (za účelom zaistenia pred prevrátením) predtým skontrolujte druh a odolnosť steny. Vyberte k druhu steny vhodné hmoždinky a skrutky. V prípade pochybností kontaktujte špecialistu. Montáž musí byť vykonaná kompetentnou osobou.

RU Перед началом сборки мебели следует проверить все элементы на предмет повреждений. Если какой-либо элемент продукта поврежден, пожалуйста, воздержитесь от установки продукта и подайте жалобу. Установка товара на поврежденные элементы означает, что Покупатель принимает их состояние, а значит, претензии по поврежденным элементам не принимаются.

Указанные максимальные значения нагрузки не должны превышать. В противном случае предмет мебели может быть поврежден или уничтожен.

Перед подвешиванием мебели или ее креплением к стене (для защиты от падений) проверьте предварительно тип и прочность стены. Подберите соответствующий типу стены дюбели и шурупы. При возникновении сомнений свяжитесь со специалистом. Монтаж должен проводиться компетентным лицом.

IT Prima di iniziare l'assemblaggio del mobile, tutti gli elementi dovrebbero essere controllati per danni. Se qualche elemento del prodotto è danneggiato, astenersi dall'installare il prodotto e presentare un reclamo. L'installazione del prodotto sulla base degli elementi danneggiati implica l'accettazione da parte dell'Acquirente della loro condizione, il che significa che il reclamo per elementi danneggiati non sarà accettato.

I valori di carico massimo specificati non devono essere superati. In caso contrario, il mobile potrebbe essere danneggiato o distrutto.

Prima di appendere i mobili, oppure attaccarli al muro (per proteggerli da ribaltamenti), verifica prima la tipologia e resistenza del muro. Scegli i tasselli e viti più adatti per il tipo di muro. In caso di dubbi contattare uno specialista. Il montaggio deve essere fatto da una persona competente.

NL Voordat u met de meubelmontage begint, moeten alle elementen op schade worden gecontroleerd. Als een onderdeel van het product beschadigd is, installeer het dan niet en dien een klacht in. Installatie van het product op basis van de beschadigde elementen betekent dat de koper hun staat accepteert, wat betekent dat de claim voor beschadigde elementen niet wordt geaccepteerd.

Overschrijd de aangegeven maximale belastingen niet. Anders kan het meubelstuk worden beschadigd of vernield.

Voordat u het meubel ophangt of bevestigt tegen de muur (om het te beschermen tegen omvallen) dient u het type en de duurzaamheid van deze muur na te kijken. Maak gebruik van pluggen en schroeven die geschikt zijn voor het type muur. Neem in geval van twijfels contact op met een specialist. De assemblage dient te worden uitgevoerd door iemand met kennis van zaken.

TR Mobilya montajına başlamadan önce tüm elemanlarda hasar olup olmadığını kontrol edilmelidir. Ürünün herhangi bir parçası hasar görmüşse, lütfen ürünü kurmayın ve şikayete bulunun. Ürünün hasarlı elemanlar bazında montajı, Alıcının durumunu kabul ettiği anlamına gelir, bu da hasarlı elemanlar için talep kabul edilmeceği anlamına gelir.

Belirtilen azami yük değerini aşmayınız, aksi takdirde mobilya parçaları zarar görebilir veya kullanılamaz hale gelebilir.

Mobilyayı duvara asmadan veya montaj etmeden önce (devrilmesini önlemek için) duvarın türünü ve dayanıklılığını kontrol edin. Duvara uygun dübelleri ve vidaları seçin. Emin olamamanız durumunda bir uzman ile irtibata geçin. Kurulum yetkili bir kişi tarafından yapılmalıdır.

RO Înainte de a începe asamblarea mobilierului, toate elementele trebuie verificate pentru a nu se deteriora. Dacă vreun element al produsului este deteriorat, vă rugăm să vă abțineți de la instalarea produsului și să depuneți o reclamație. Instalarea produsului pe baza elementelor deteriorate înseamnă acceptarea de către Cumpărător a stării lor, ceea ce înseamnă că reclamația privind elementele deteriorate nu va fi acceptată.

Valoriile maxime de sarcină specificate nu trebuie depășite. În caz contrar, piesa de mobilier poate fi deteriorată sau distrusă.

Înainte de suspendarea unei piese de mobilier sau atașarea acestuia la perete (pentru a preveni bascularea), verificați în prealabil tipul și gradul de rezistență a peretelui. Montați diblurile și șuruburile adecvate pentru tipul de perete. În caz de îndoieli, consultați un specialist. Instalarea trebuie să fie efectuată de către o persoană competentă.

ES Antes de comenzar el montaje de los muebles, todos los elementos deben comprobarse en busca de daños. Si algún elemento del producto está dañado, absténgase de instalar el producto y presente una queja. La instalación del producto sobre la base de los elementos dañados supone la aceptación por parte del Comprador de su estado, por lo que no se aceptará la reclamación de elementos dañados.

No se deben exceder los valores de carga máxima especificados. De lo contrario, el mueble puede dañarse o destruirse.

Antes de colgar o fijar el mueble en el muro (a fin de proteger contra el vuelco del mueble), compruebe de antemano la naturaleza y la resistencia de la pared. Seleccione tacos y tornillos adecuados para el tipo de la pared. En caso de duda, consulte a un especialista, debiendo efectuar este montaje una persona competente.

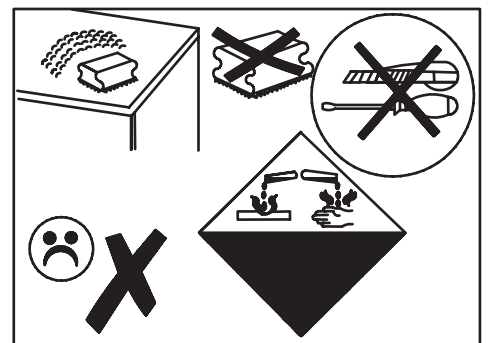

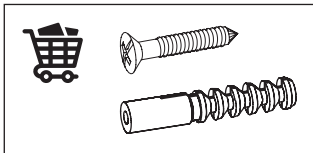
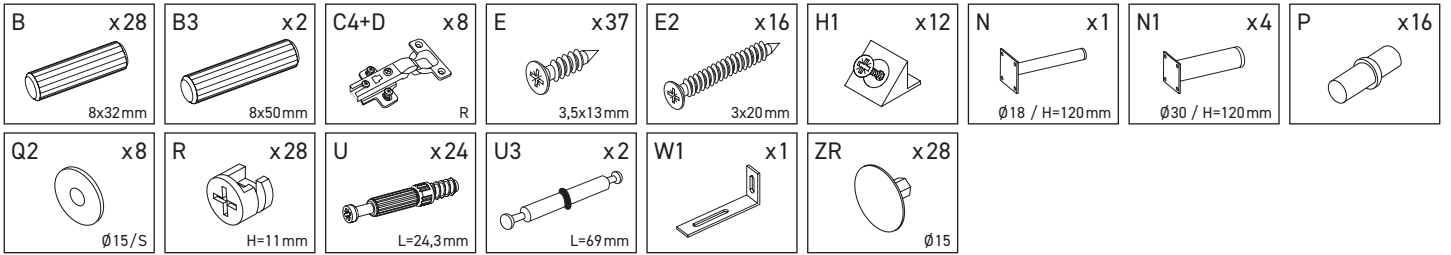

B-1	1130	398	16	x 2	1/1
B-2	539	365	16	x 2	1/1
B-3	539	350	16	x 4	1/1
B-4	1293	332	16	x 1	1/1
B-5	1293	332	16	x 1	1/1
B-6	1293	365	16	x 1	1/1
B-7	496	642	16	x 2	1/1
B-8	496	642	16	x 1	1/1
B-9	496	642	16	x 1	1/1
B-10	1293	65	65	x 2	1/1
B-11	554	1307	3	x 1	1/1
B-12	554	1307	3	x 1	1/1

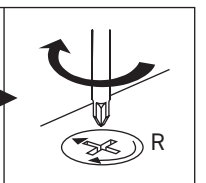
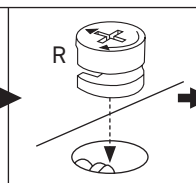
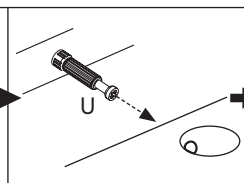
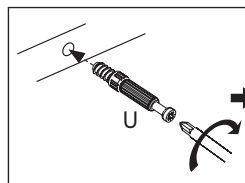
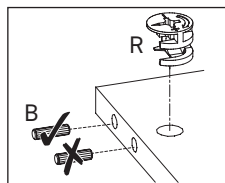
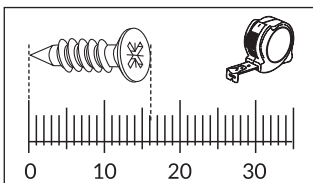
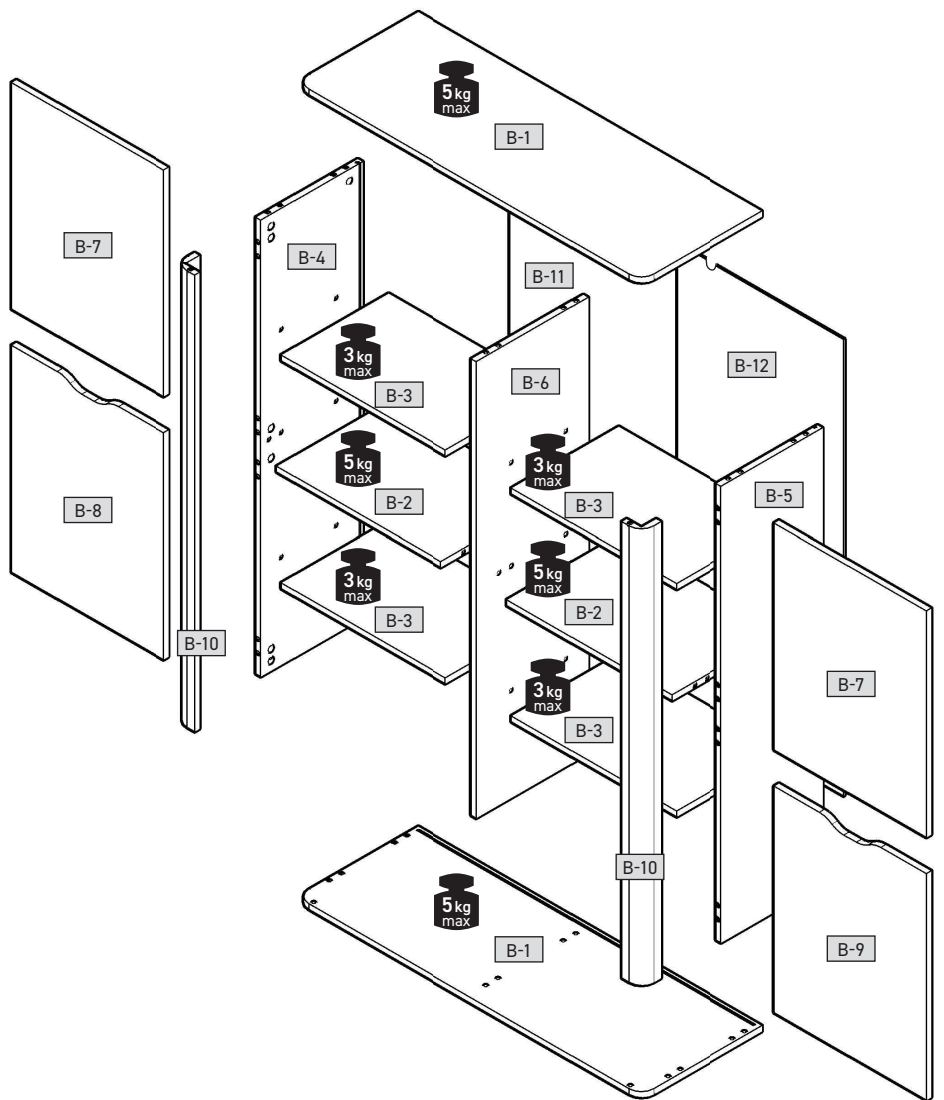



1

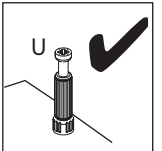
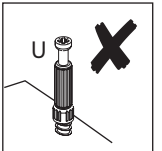
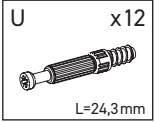
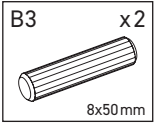
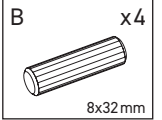
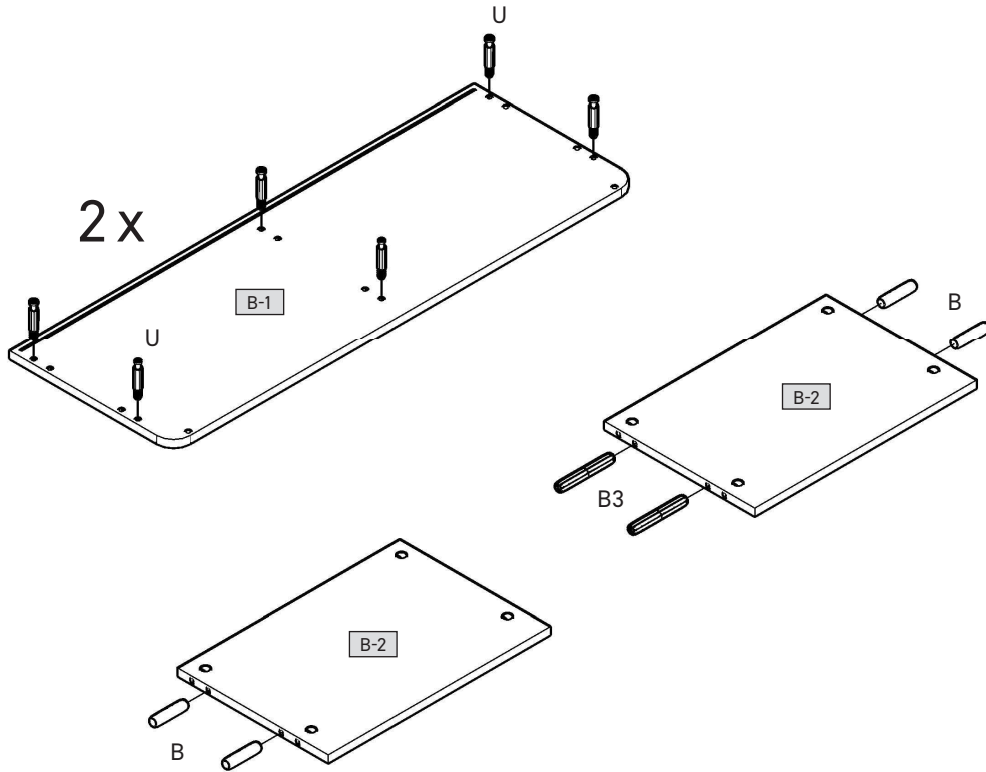

2

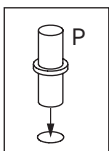
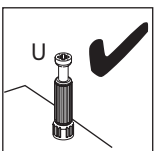
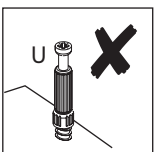
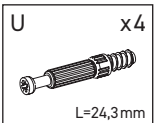
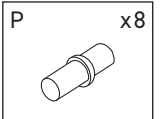
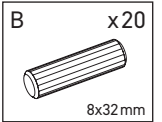
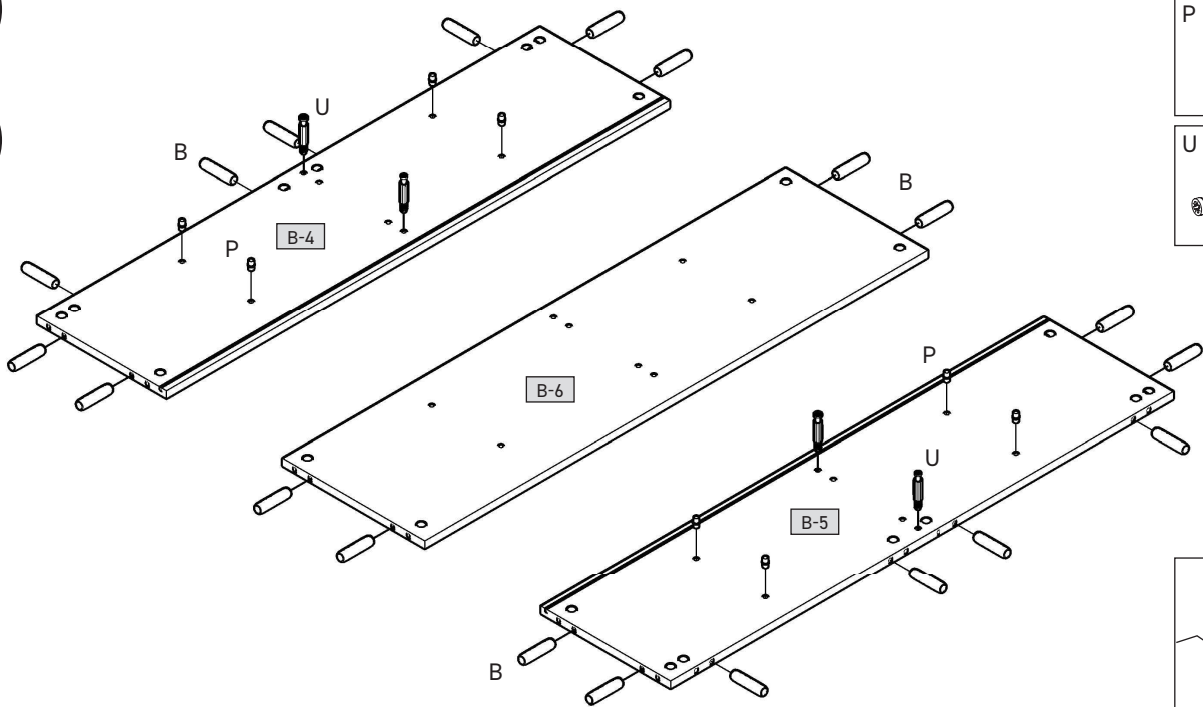



3

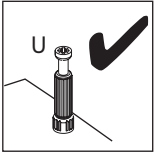
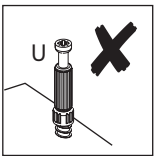
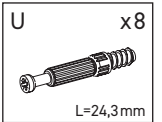
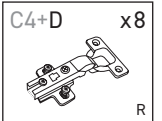
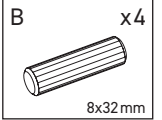
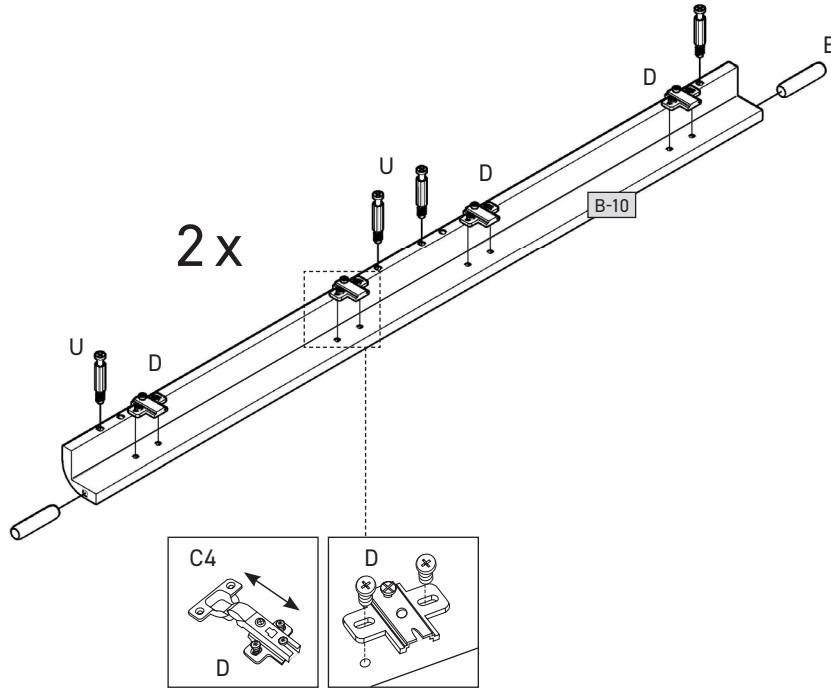

4

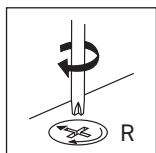
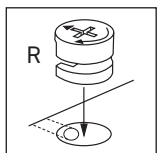
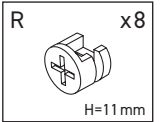
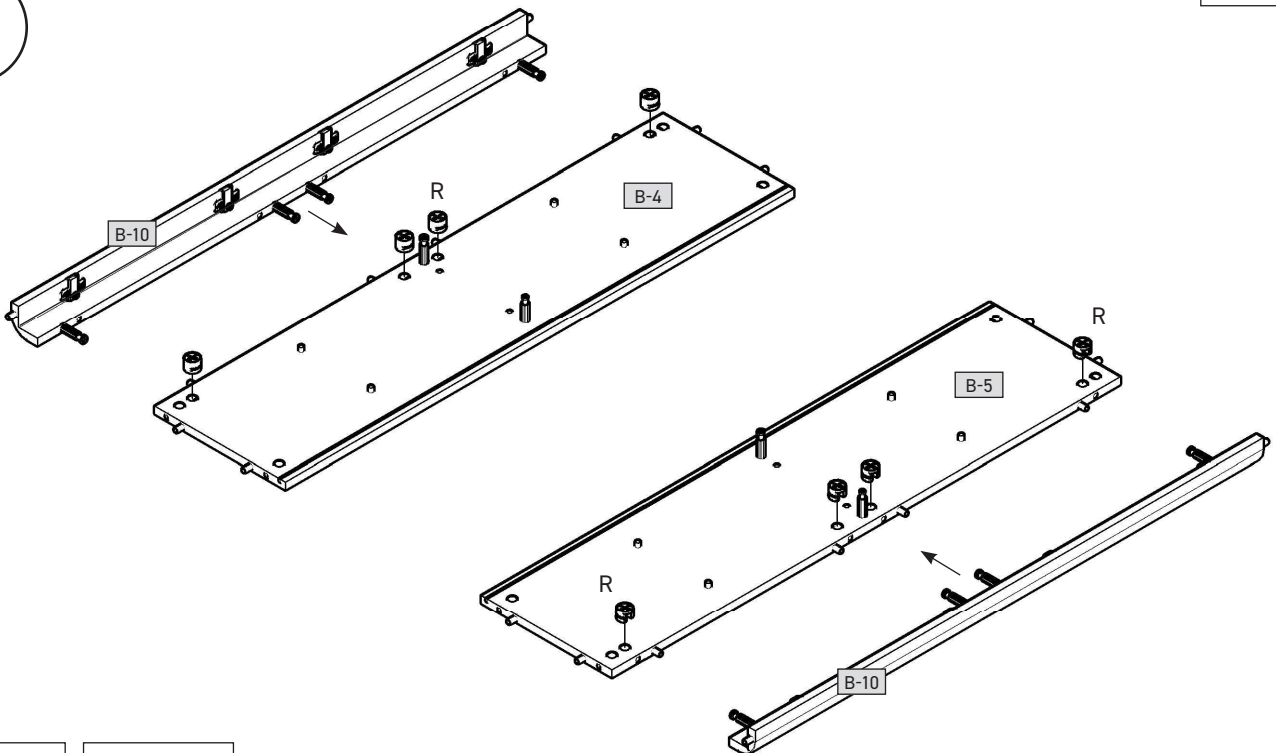



5

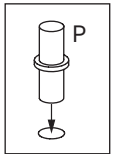
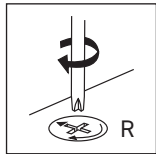
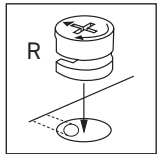
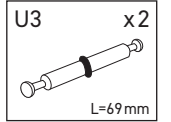
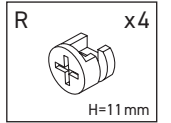
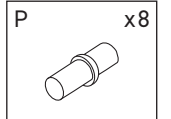
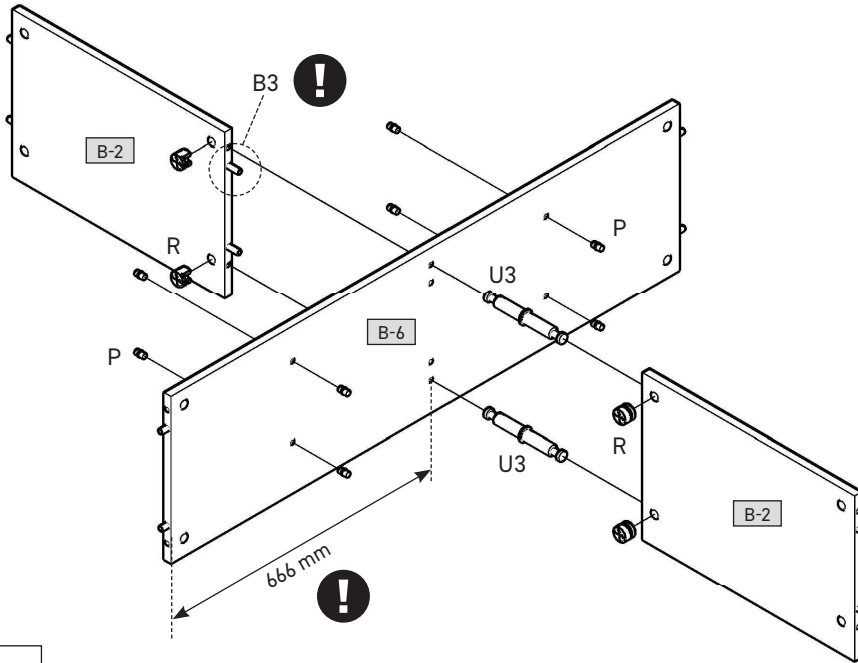

6

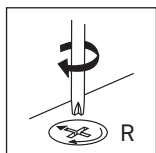
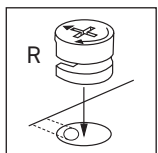
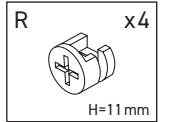
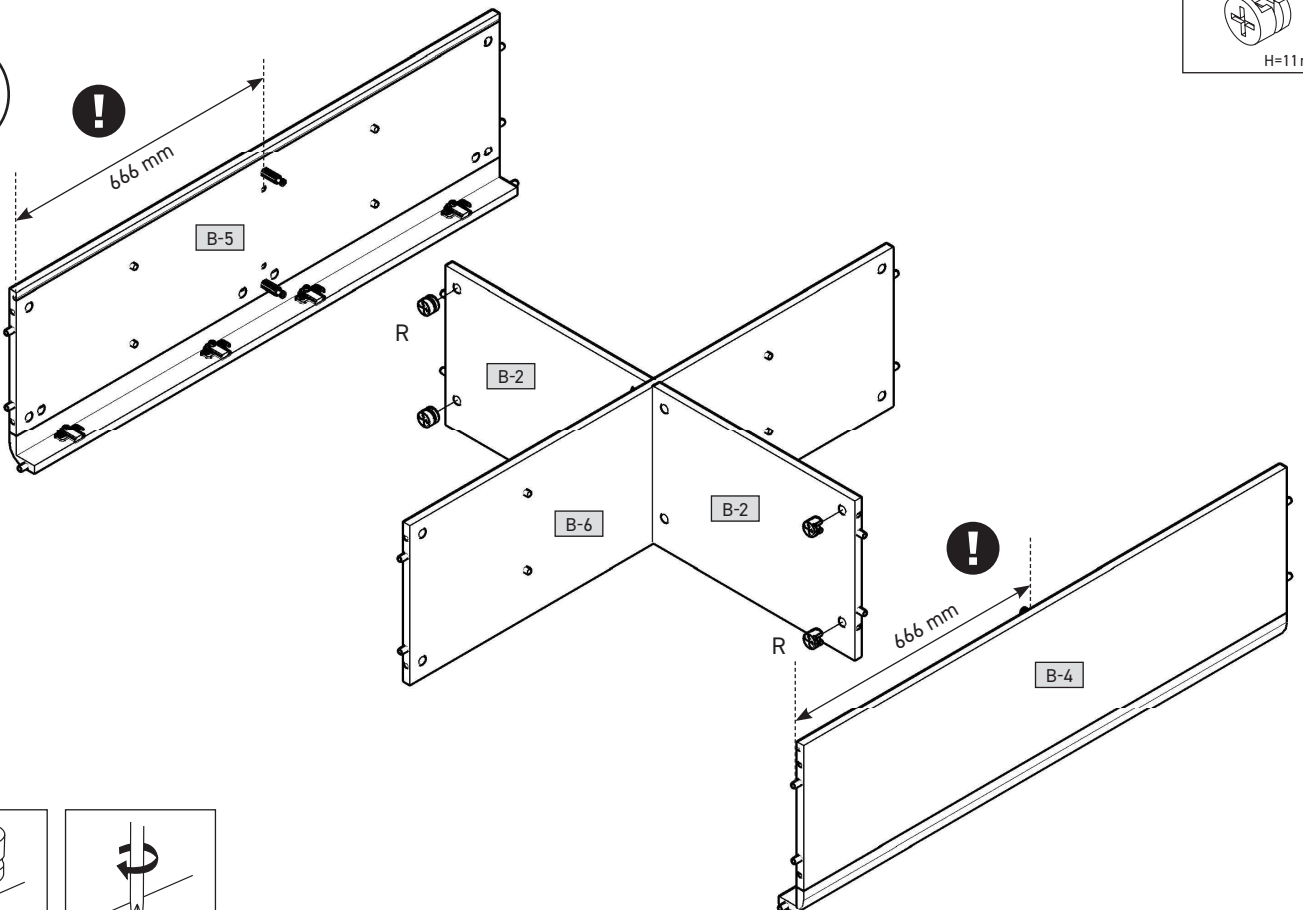



7

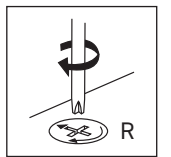
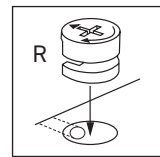
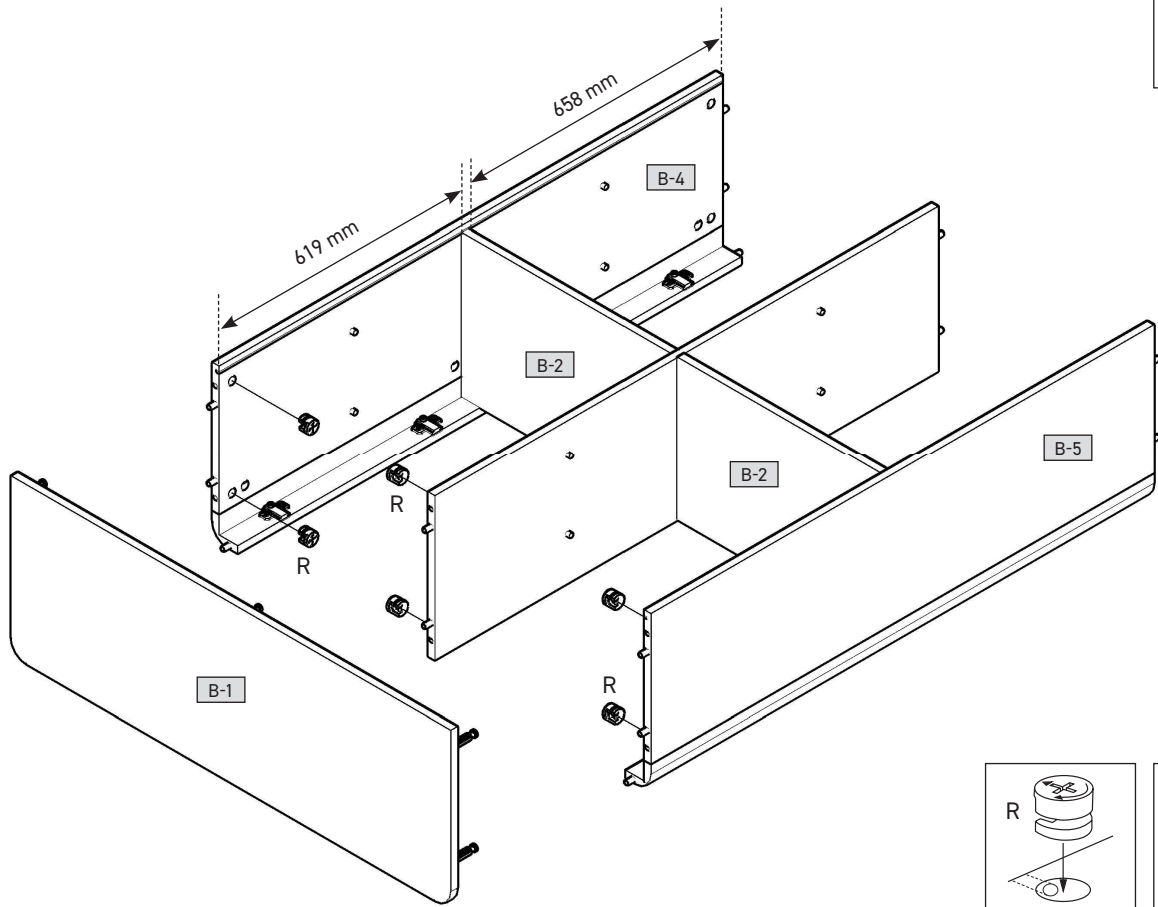
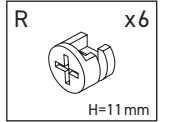

8

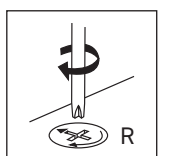
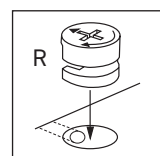
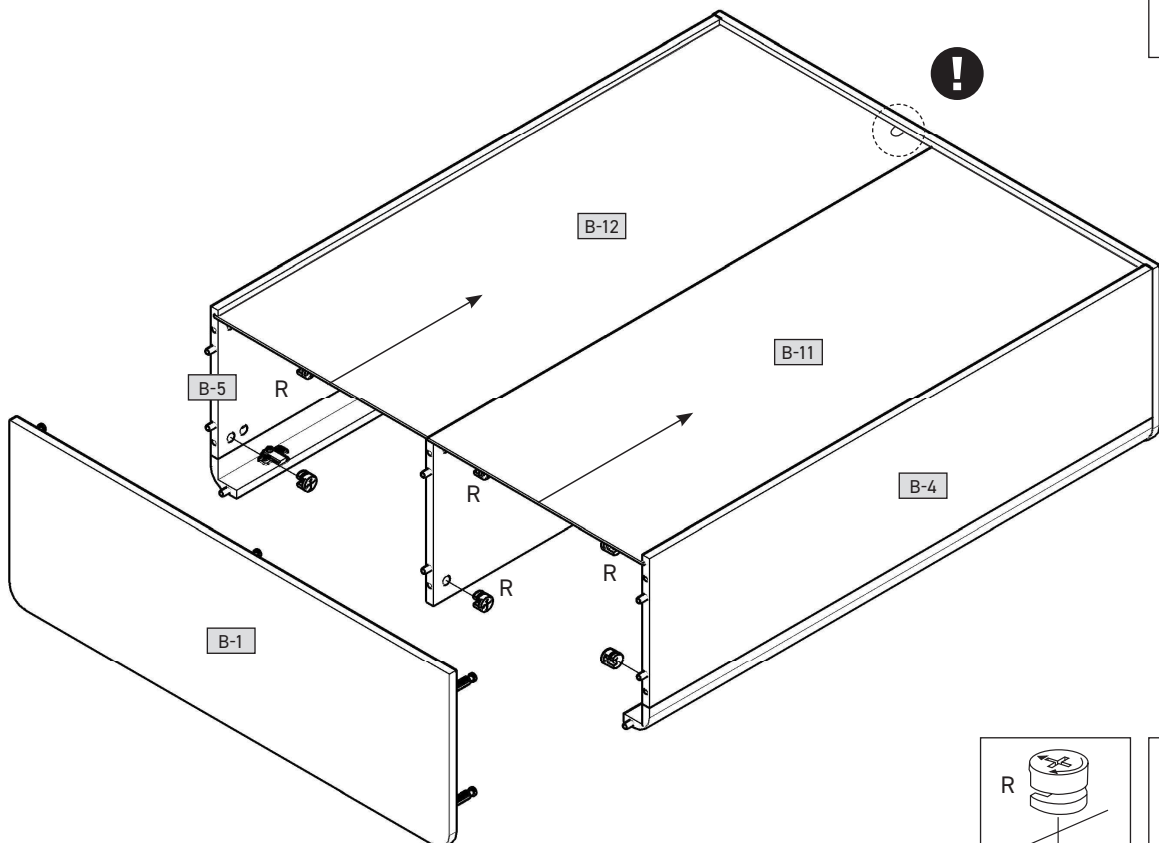
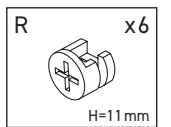



9

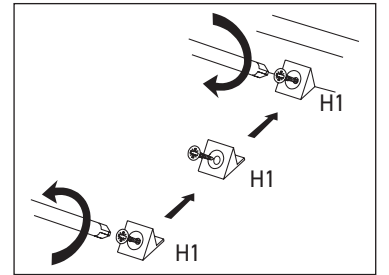
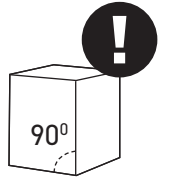
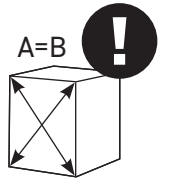
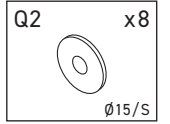
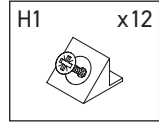
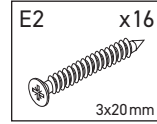
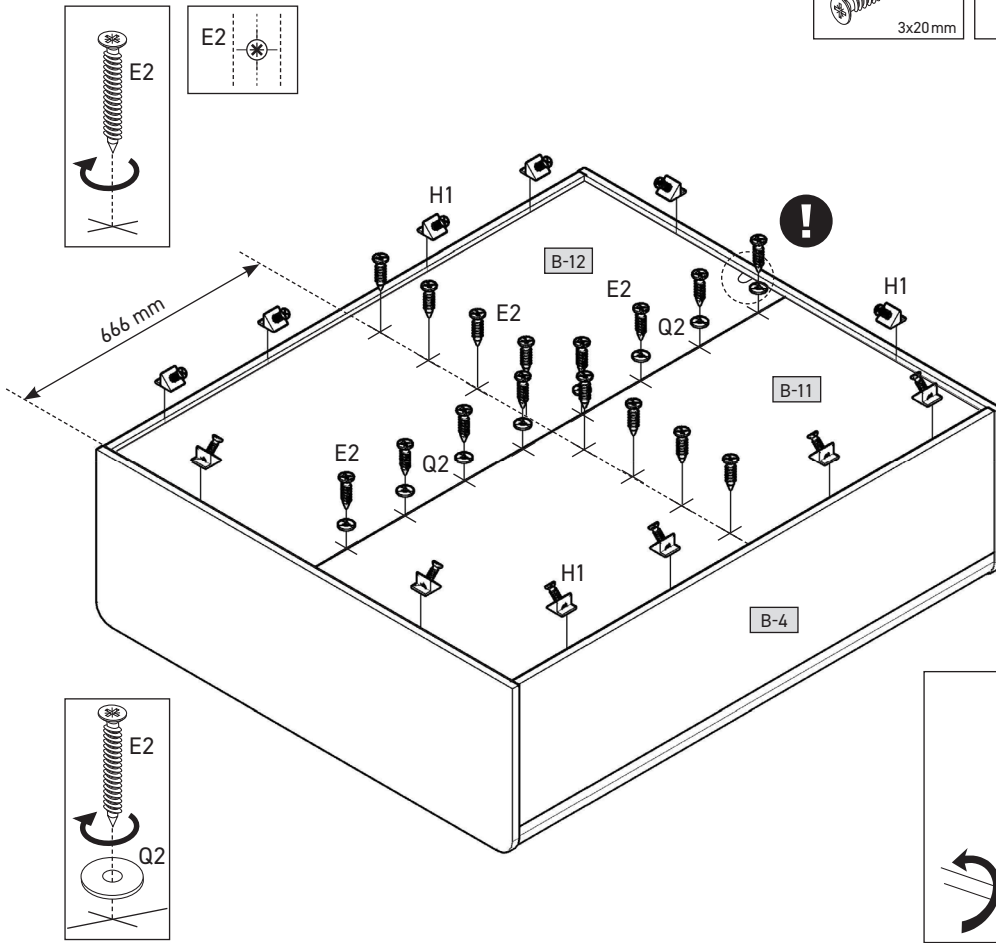

10

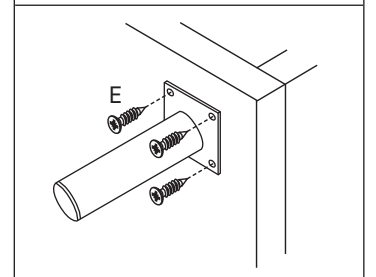
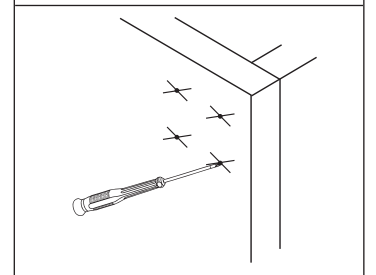
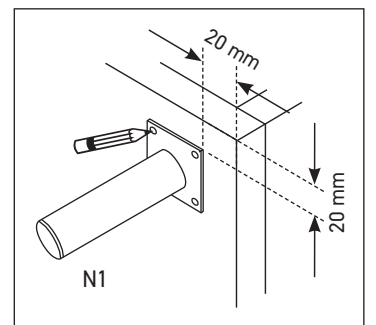
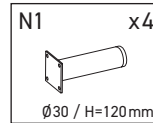
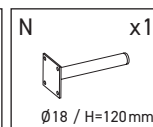
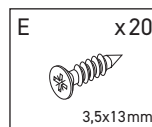
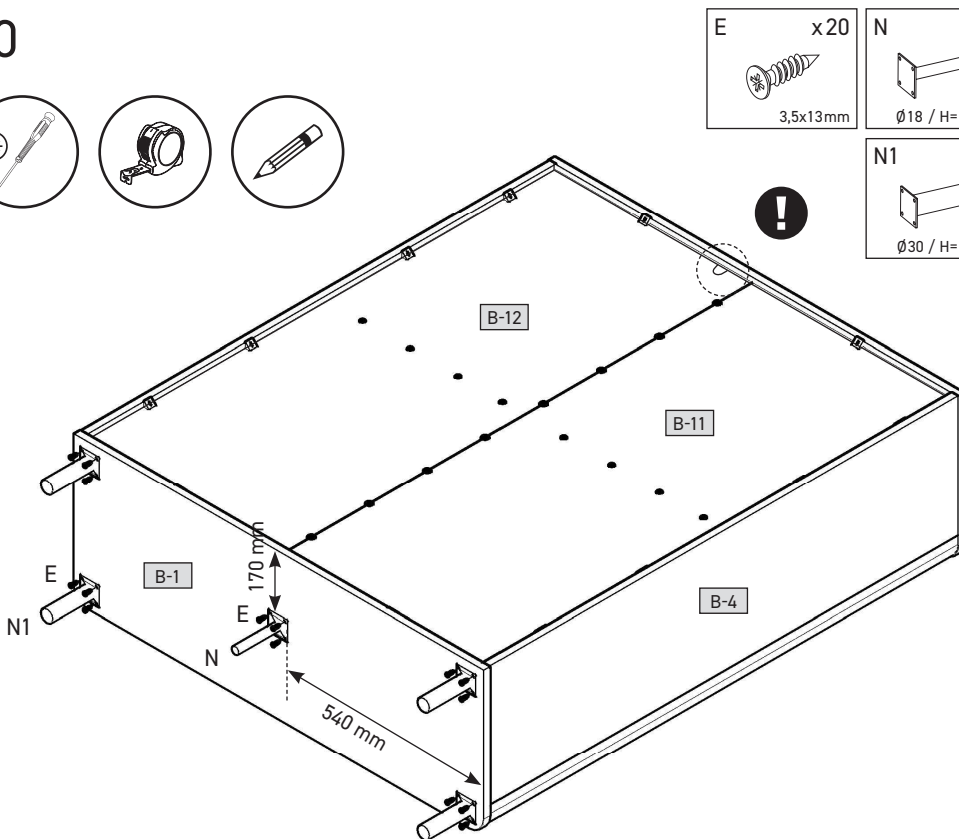
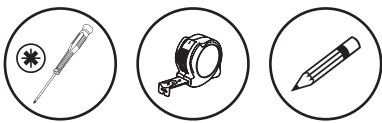



11

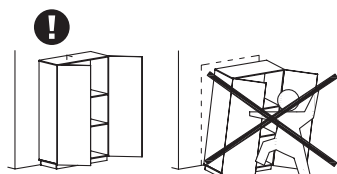
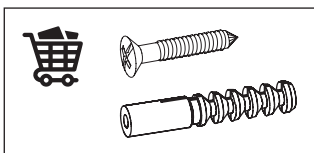
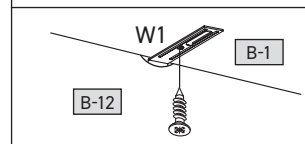
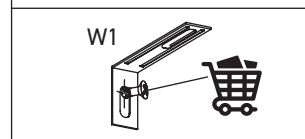
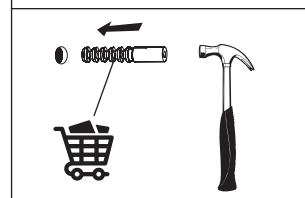
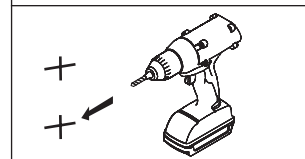
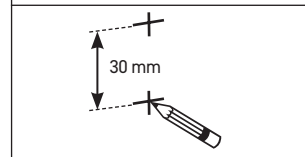
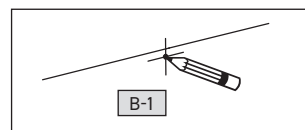
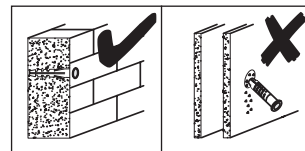
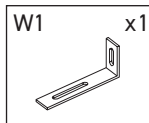
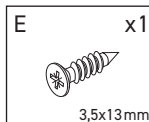
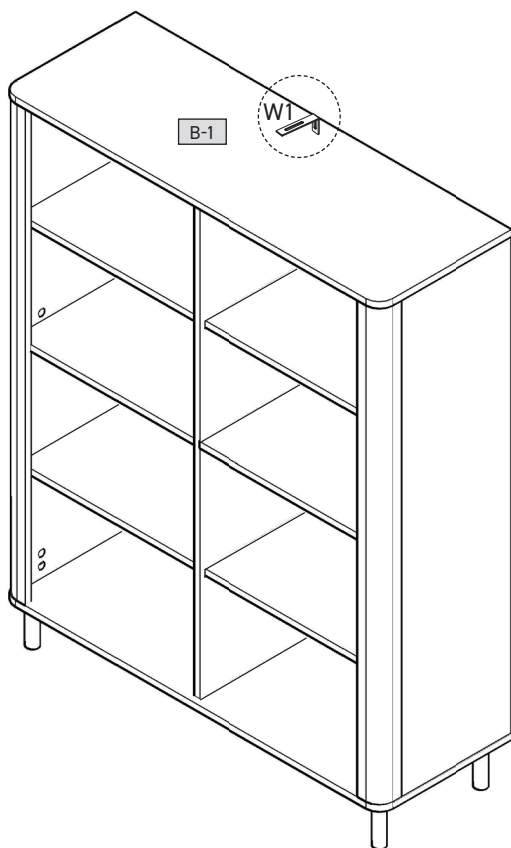
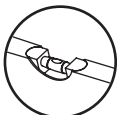

12

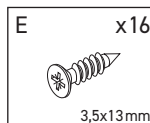
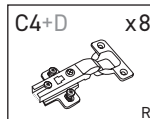
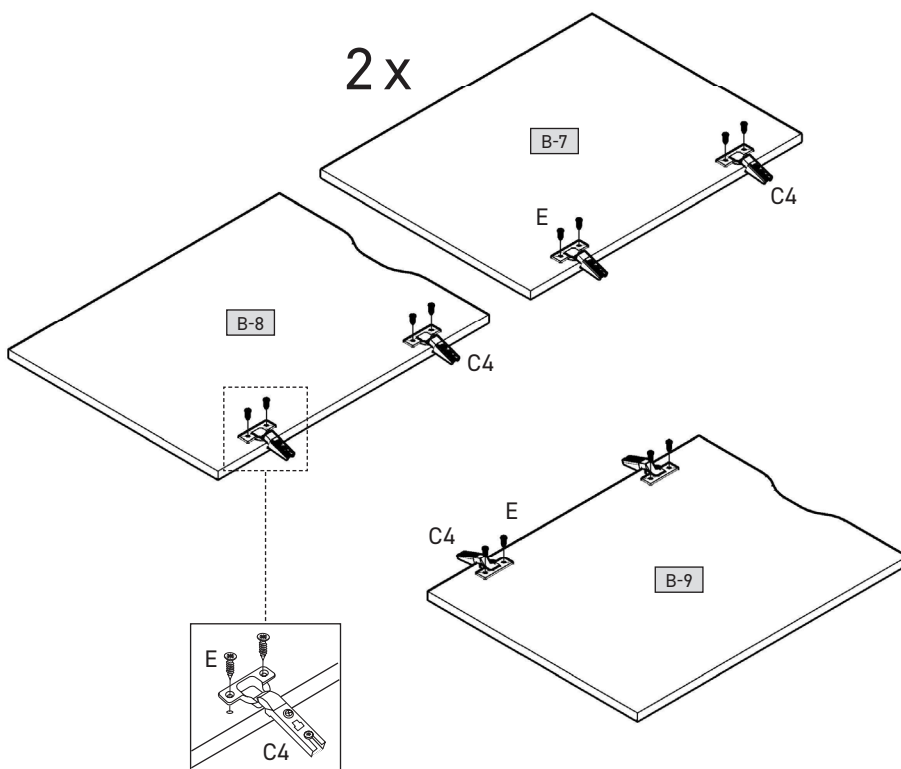



13

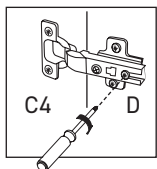
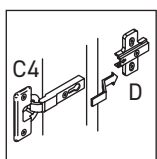
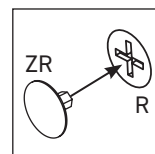
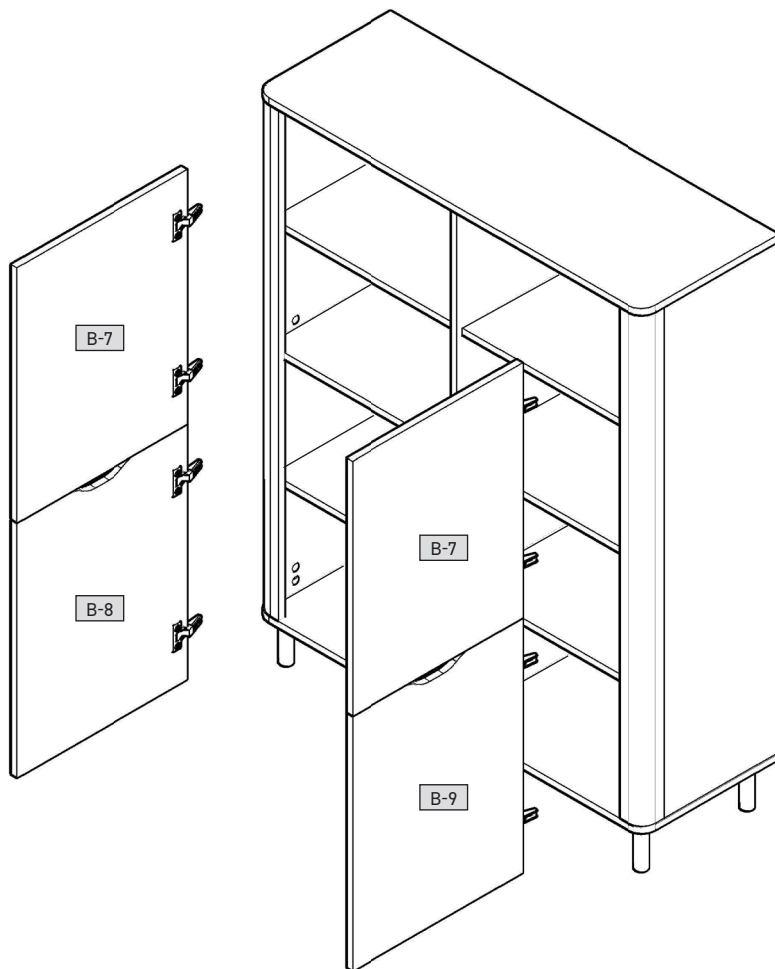
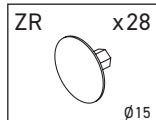

14

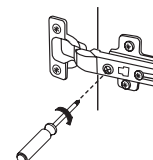
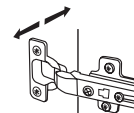
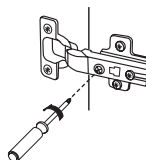
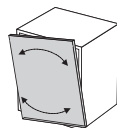
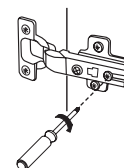
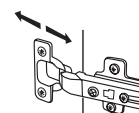
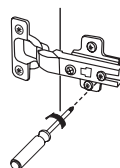
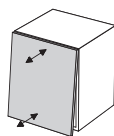
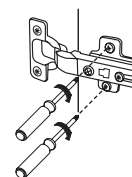
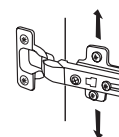
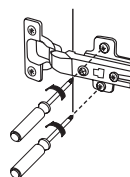
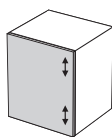
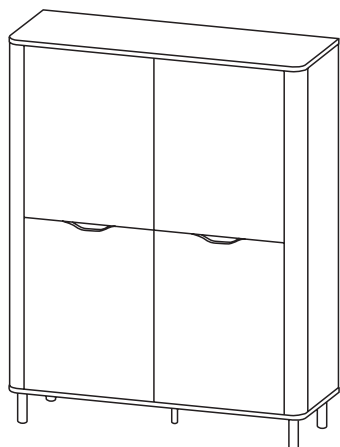

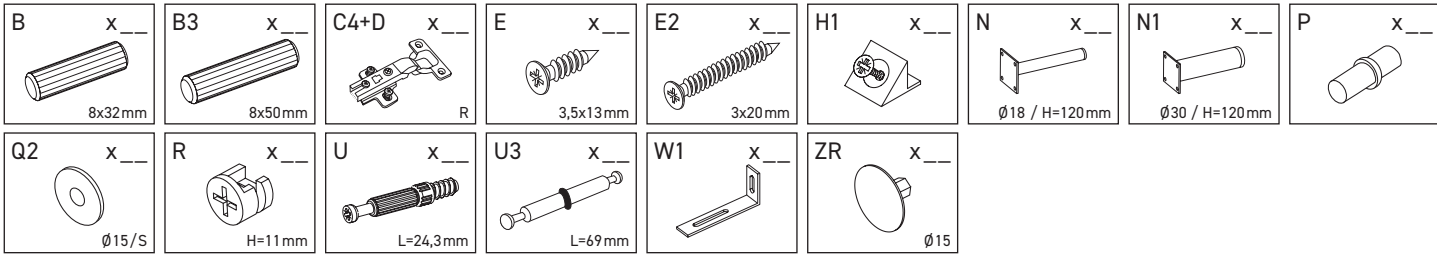

B-1	1130	398	16	x 2	1/1
B-2	539	365	16	x 2	1/1
B-3	539	350	16	x 4	1/1
B-4	1293	332	16	x 1	1/1
B-5	1293	332	16	x 1	1/1
B-6	1293	365	16	x 1	1/1
B-7	496	642	16	x 2	1/1
B-8	496	642	16	x 1	1/1
B-9	496	642	16	x 1	1/1
B-10	1293	65	65	x 2	1/1
B-11	554	1307	3	x 1	1/1
B-12	554	1307	3	x 1	1/1

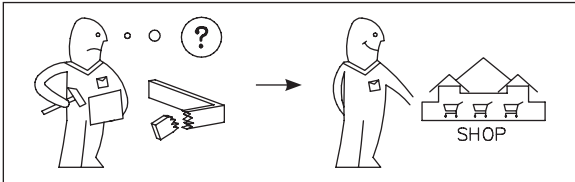
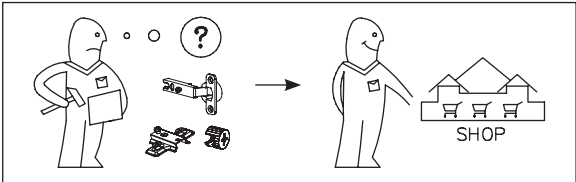
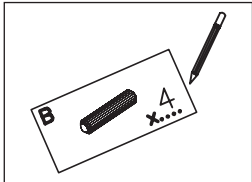
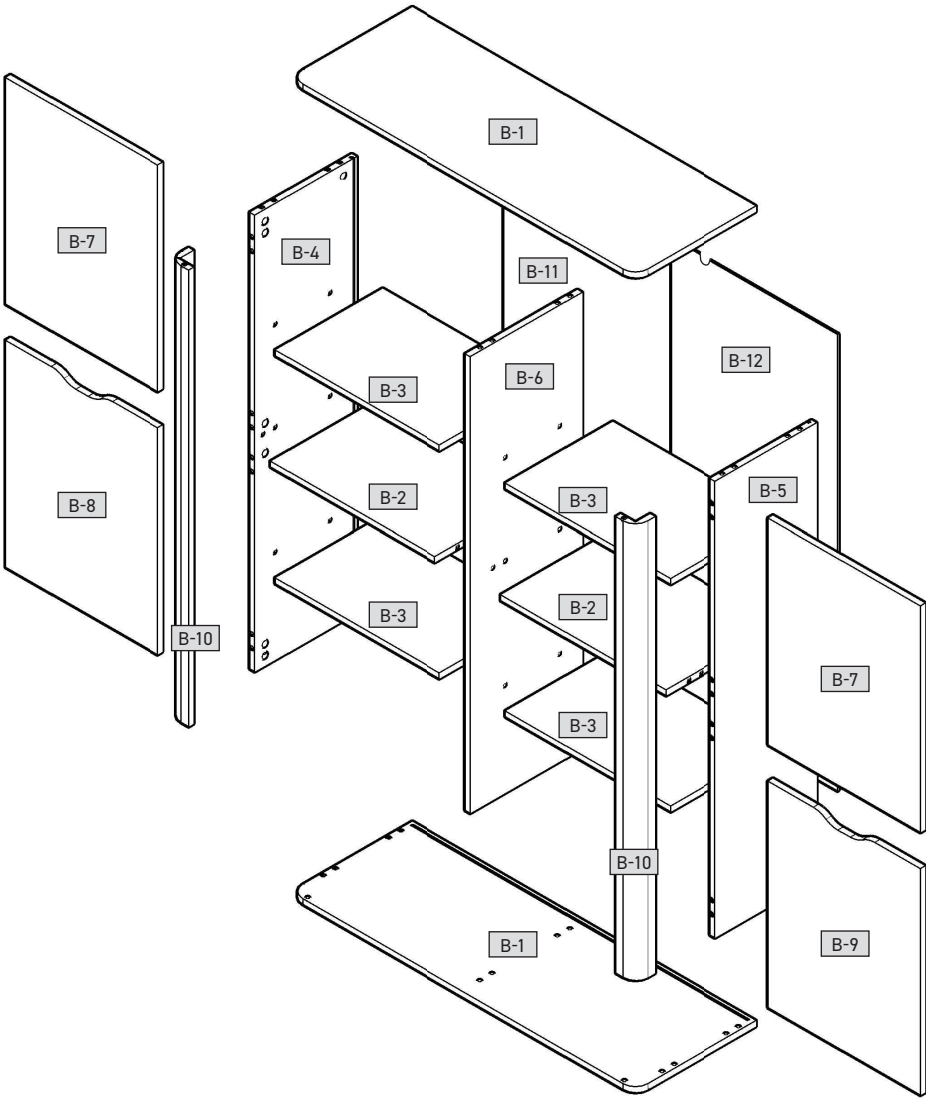

(DE)	Möbel aus Naturholz und Plattenwerkstoffen
(PL)	Mebel z drewna naturalnego oraz płył drewnopochodnych
(NL)	Meubelen van natuurhout en plaatmateriaal
(GB)	Furniture made of natural wood and panel materials
(IT)	Mobili in legno naturale e materiali pannellati
(FR)	Meuble en bois naturel et plaque en dérivé du bois

Liebe Kundin, lieber Kunde,

Wir freuen uns, Ihre Bestellung erfolgreich zu empfangen und Sie aus Naturholz gefertigt Möbelstück gekauft haben, eine Hochglanzfront oder eine matte Kunststofffront – jedes Möbelstück hat seine ganz speziellen Eigenschaften. Auch Holzbeschaffenheit und -struktur, wie zum Beispiel kleine Äste bei Naturholzbeinen, sind Teil der individuellen Ausprägung jedes einzelnen Möbelstückes.

Da Möbel aus Naturholz ständigen Klima- und Feuchtigkeitsschwankungen ausgesetzt sind, können vereinzelt Veränderungen in der Oberfläche auftreten, wie z.B. Haarrisse oder Farbveränderungen. Generell nimmt im Laufe der Zeit die Helligkeit ab und die Farbsättigung zu – das Holz dunkelt nach.

Die glatte Natur-Rohstoff wie Holz ein normaler Prozess. Dieses Büchlein soll Ihnen ein paar Tipps zur Pflege Ihres Möbelstücks geben, damit Sie lange Freude daran haben können.

Grundsätzlich gilt:

• Möbeln sind natürlichen Gegenstände auf die ein gewisses Maß an Verschleiß einzuwirken stellen.
• Keine Kratzen direkt auf die Möbel stellen.
• Verschlusste Flüssigkeiten sofort aufwischen.
• In regelmäßigen Abständen einen festen Sitz von Schrauben und Beschlägen kontrollieren.
• Der typische, aromatische Holzgeruch des Naturholzmöbels immer ein Merkmal für die Qualität des Holzmaterials.
• Heiße Stellen an den Händen entstehen durch einen natürlichen Hautausstritt und können mit einem trockenen, fusselfreien Tuch abpoliert werden.

• Auch von anderen Holz-, Lack-, Leder- oder Polstermaterialien ist unvermeidbar. Diese Gerüche verschwinden mit der Zeit von allein.
• Was Sie tun können, ist, wenn möglich, Sie in der Anfangszeit häufiger und/oder wischen Sie die Möbel leicht feucht mit Wasser aus, das mit ein wenig Essig versetzt ist.

• Bewahren Sie diese Hinweise gut auf.

Pflegehinweise für Möbel aus Plattenwerkstoffen
Verwenden Sie zur Pflege Ihres Möbels aus Plattenwerkstoffen am besten ein weiches, sauberes, trockenes oder leicht feucht ab.

Grundsätzlich gilt: Verwenden Sie bitte auf keinen Fall folgende Reinigungs- und Putzmittel:

• **Microwaschmittel** oder **Schmutzradierer**. Diese enthalten häufig feine Schmelzpartikel, die zu einem Zerknutschen der Oberfläche führen.
• **Scharfe chemische Substanzen** sowie **scheuernde Putz- oder Lösungsmittel**. Diese können die Oberflächen ebenfalls beschädigen;

• **Scheuerpapier, Stahlwolle** oder **Poliermittel**. Sie zerstören die Oberfläche so stark, dass eine Aufarbeitung nicht mehr möglich ist;
• **Staubsauger** und **Bürsten** können die Oberflächen zerkratzen und **Dampfreiniger**. Durch den hohen Druck und die Hitze, mit denen der Wasserdampf auf die Oberflächen trifft, können diese beschädigt werden oder sich sogar vom Untergrund ablösen.

Ihre Produktentwicklung

(TR)

(RU)

(RO)

(CZ)

(SK)

(HU)

(NL)

Beste klant,
Hartelijk dank voor uw bestelling!
Het maakt niet uit of u een meubelstuk wilt kopen of een meubelstuk wilt voortkopen of een matte plastic voorkant heel gekocht – elk meubelstuk heeft zijn eigen karakteristiek. Ook het kleurenspectrum van de staat en structuur van het hout zoals kleine ratten bij natuurhout meubelen maken deel uit van de individuele look van elk afzonderlijk meubelstuk.

Omdat meubelen van natuurhout zijn biogegeseld zijn permanente klimatiele veranderingen in de omgeving van de af te best.
• **W**anneer u een meubel koopt, moet u er rekening mee houden dat het de bovengangs zoals haarscheutjes of kleurveranderingen. In het algemeen neemt na verloop van tijd de helderheid af en de kleurverzadiging toe – het hout wordt donkerder.
De genoemde wijzigingen vormen bij een natuurlijke grondstof zoals hout een normaal proces. Dit boekje moet u een paar tips geven om de levensduur van uw meubel, zodat u er lange tijd plezier aan kunt beleven.

The following applies in general:
• Don't place any hot objects on the furniture.
• Don't place candles directly on the furniture.
• Immediately wipe off any spilled liquids.
• Regularly check if the screws and fittings are tight.

• The typical, aromatic wooden odour is always a proof of quality for natural wood furniture.
• The natural emission of resin may produce bright spots on the knots, which can be polished with a dry, lintfree cloth.
• Initially, a slight intrinsic odour is unavoidable for other wooden, paint, leather or upholstery materials too. These odours automatically disappear after a while. If you want to speed up this process, ventilate more often at the beginning and/or wipe out the furniture with a slightly damp cloth which was soaked in water mixed with a small amount of vinegar.

• Keep these notes in a safe place.
Care notes for furniture made of panel materials
We recommend using a soft, lint-free cloth or a shammy for conditioning your piece of furniture made of panel materials. Wipe off the surfaces with a slightly damp cloth or shammy.
The following applies in general:
Please don't use the following detergents or cleaning agents at all:
• **microfibre cloths or dirt erasers.** They often contain fine abrasive particles which can cause scratches on the surfaces;
• **aggressive chemical substances** as well as **abrasive cleaning agents** or solvents. They may damage the surfaces too;
• **scouring powder, steel wool** or **scouring pads.** They destroy the surface so badly that reconditioning is impossible;
• **vacuum cleaners.** The nozzles and brushes can cause scratches on the surfaces;
steam cleaners. The surfaces may be damaged or separated from the ground due to the high pressure and heat of the water vapour.

De productontwikkelingsafdeling

(GB)

Dear customer,
Thank you for your order!
No matter if you bought a piece of furniture made from natural wood, a high-gloss front or a plastic front – every piece of furniture has unique characteristics. Even the texture and structure of wood, such as small knots in natural wood furniture, are part of the individual charisma of each piece of furniture.

Since natural wood furniture are permanently exposed to climate and humidity fluctuations, changes to the surface may occur (e.g. hair cracks or changes in colour) in some cases. In general, brightness decreases and colour saturation increases in the course of time – the wood darkens. The changes mentioned above are normal for natural raw materials such as wood. This booklet provides some care tips for your piece of furniture so that you can enjoy it for a long time.

The following applies in general:
• Don't place any hot objects on the furniture.
• Don't place candles directly on the furniture.
• Immediately wipe off any spilled liquids.
• Regularly check if the screws and fittings are tight.

• The typical, aromatic wooden odour is always a proof of quality for natural wood furniture.
• The natural emission of resin may produce bright spots on the knots, which can be polished with a dry, lintfree cloth.
• Initially, a slight intrinsic odour is unavoidable for other wooden, paint, leather or upholstery materials too. These odours automatically disappear after a while. If you want to speed up this process, ventilate more often at the beginning and/or wipe out the furniture with a slightly damp cloth which was soaked in water mixed with a small amount of vinegar.

• Keep these notes in a safe place.
Care notes for furniture made of panel materials
We recommend using a soft, lint-free cloth or a shammy for conditioning your piece of furniture made of panel materials. Wipe off the surfaces with a slightly damp cloth or shammy.
The following applies in general:
Please don't use the following detergents or cleaning agents at all:
• **microfibre cloths or dirt erasers.** They often contain fine abrasive particles which can cause scratches on the surfaces;
• **aggressive chemical substances** as well as **abrasive cleaning agents** or solvents. They may damage the surfaces too;
• **scouring powder, steel wool** or **scouring pads.** They destroy the surface so badly that reconditioning is impossible;
• **vacuum cleaners.** The nozzles and brushes can cause scratches on the surfaces;
steam cleaners. The surfaces may be damaged or separated from the ground due to the high pressure and heat of the water vapour.

Your product development team

(IT)

Gentili clienti,
Sentiti ringraziamenti per il vostro ordine!
A prescindere che abbiate scelto un mobile realizzato in legno naturale, un fronte lucido o un fronte di materiale plastico opaco – ogni esemplare ha sue particolarità. Anche le caratteristiche e la struttura del legno, quali ad esempio rami minori nei mobili di legno naturale, sono parte del fascino individuale di ogni singolo mobile.

Dato che i mobili in legno naturale sono esposti al continuo variare del clima e dell'umidità, è probabile che in superficie insorgano mutamenti quali crepe capillari o cambiamenti di colore. Generalmente con passar del tempo, diminuisce la chiarezza e aumenta la saturazione del colore – il legno si scurisce. I citati mutamenti sono un normale processo dei materiali naturali, quali appunto il legno.

Il presente libretto intende darvi alcuni suggerimenti sulla cura del vostro mobile, affinché vi procuri lunghe soddisfazioni.

Sostanzialmente vale:

• Non poggiare oggetti roventi sui mobili dei mobili.
• Non poggiare candele a diretto contatto dei mobili.
• Asciugare subito i liquidi sversati.
• Ad intervalli periodici controllare se viti e cerniere sono salde.

• Il caratteristico odore fragrante è sempre una prova di qualità dei mobili in legno naturale.
• Le macchie chiare sui rami si formano per via della naturale fuoriuscita di resina, e sono levigabili con un panno asciutto che non lascia peli.
• Anche trattandosi di altri materiali lignei, di vernice, pelle o imbottiti, all'inizio è inevitabile un leggero odore caratteristico. Dopo qualche tempo però, questi odori svaniscono da sé.
• Potete aiutare a farli volatilizzare in minor tempo cambiando più spesso aria all'inizio e/o passando sui mobili un panno umido d'acqua con qualche goccia d'aceto.
• Conservare bene le presenti istruzioni.

Istruzioni sulla cura dei mobili in materiali pannellati

Per la cura dei mobili in materiali pannellati si consiglia di usare un panno morbido, che non lascia peli, o un panno di pelle. Passare il panno leggermente umido sulle superfici.

Sostanzialmente vale: In nessun caso utilizzare i seguenti detergenti e prodotti per la pulizia:

• **panni in microfibra o spugne a tampone.** Questi prodotti contengono spesso fini particelle abrasive, che possono provocare sgraffiature sui mobili;
• **forti sostanze chimiche nonché detersivi o solventi abrasivi.** Anche questi prodotti possono aggredire le superfici;

• **polvere abrasiva, paglietta d'acciaio** o **spugne abrasive.** Rovineranno la superficie in modo tale che non sarebbe più possibile riparare;

• **aspirapolvere.** Bocchette e spazzole possono sgraffiare le superfici;
• **pulitrice a vapore.** Per via dell'elevata pressione e calore con cui il vapore colpisce le superfici, esse rischiano di deteriorarsi o addirittura staccarsi dalla sottostruttura.

Area Sviluppo prodotti

(FR)

Chère cliente, cher client,
Merci pour votre commande !
Peu importe que vous ayez acheté un meuble fabriqué en bois naturel, un face haute brillante ou une face en plastique mat – chaque meuble a ses propriétés spécifiques. Même les propriétés et la structure du bois, comme par exemple les petits nœuds sur des meubles en bois naturel, font partie de l'aspect de chaque meuble.

Comme les variations permanentes du climat et de l'humidité, il se peut que quelques modifications surviennent sur la surface, comme par exemple de fines fissures ou des décorations. En règle générale, au cours du temps, la clarté du meuble diminue et la saturation des couleurs augmente. Les modifications susnommées sont un processus normal des matières naturelles.

Ce petit livret vous donne quelques astuces sur l'entretien de votre meuble pour que vous puissiez en profiter longtemps.

En règle générale :
• Ne pas poser d'objets chauds sur le meuble.

• Ne pas poser de bougies directement sur le meuble.

• Essayer immédiatement les liquides renversés.

• A intervalles réguliers, contrôler que vis et les ferrures sont bien en place.

• L'odeur aromatique typique du bois est toujours une preuve de qualité des meubles en bois naturel.

• Les endroits clairs sur les nœuds se produisent par une sécrétion naturelle de résine qui s'élimine avec un chiffon sec non pelucheux.
• Les autres matériaux, comme le bois, la peau ou le cuir, ont également un léger dégoût inévitablement une légère odeur. Ces odeurs disparaissent d'elles-mêmes avec le temps. Si vous souhaitez qu'elles disparaissent plus vite, au début, aérez plus souvent et essayez les meubles avec un chiffon légèrement imbibé d'eau mélangée avec un peu de vinaigre.

• Conservez bien cette notice.

Consignes de soin pour les meubles avec des plaques en dérivé du bois

Pour l'entretien de votre meuble en laque, utilisez un chiffon doux non pelucheux à une partie de vinasse. Essayez.

En règle générale :
• Veillez à utiliser des produits doux.

• **Chiffons à microfibrés ou gomme à saletés.** Ils contiennent souvent de fines particules abrasives qui peuvent rayer les surfaces ;

• **substances chimiques agressives** ainsi que **détergents abrasifs**.

Ces produits peuvent également endommager les surfaces ;

• **Consignes de soin pour les meubles avec des plaques en dérivé du bois**

Pour l'entretien de votre meuble en préférence un chiffon doux non pelucheux à une partie de vinaigre. Essayez.

En règle générale :
• Veillez à utiliser des produits doux.

• **Chiffons à microfibrés ou gomme à saletés.** Ils contiennent souvent de fine particules abrasives qui peuvent rayer les surfaces ;

• **substances chimiques agressives** ainsi que **détergents abrasifs**.

Ces produits peuvent également endommager les surfaces ;

• **Consignes de soin pour les meubles avec des plaques en dérivé du bois**
Pour l'entretien de votre meuble en préférence un chiffon doux non pelucheux à une partie de vinaigre. Essayez.

• **Consignes de développement de produits**

