

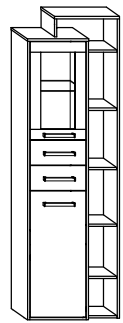

RIO-29 WITRYNA P1D2S

→ 64 ↑ 203 ↘ 41



x 14 	x 28 	x 28 	x 22 	x 4 	x 4 		
x 14 	x 6 	x 4 	x 32 (3,5x16) 	x 8 (3,5x30) 	x 4 	x 70 	x 1
x 2 kpl. (350 mm) 							60 min

1 - FAZY MONTAŻU

A - OZNACZENIE ELEMENTÓW

a - OZNACZENIE AKCESORIÓW

1

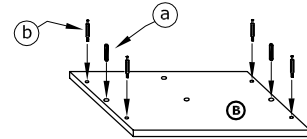
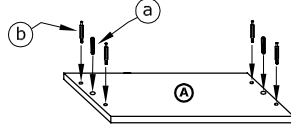
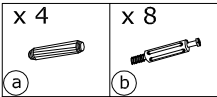

2

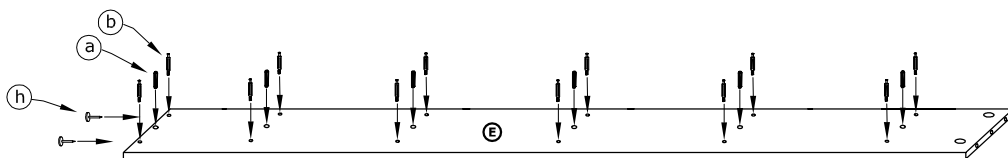
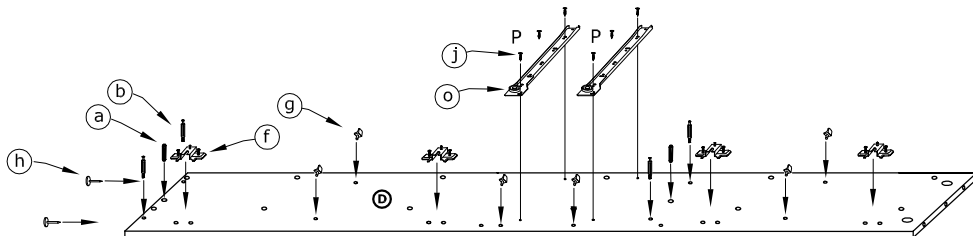
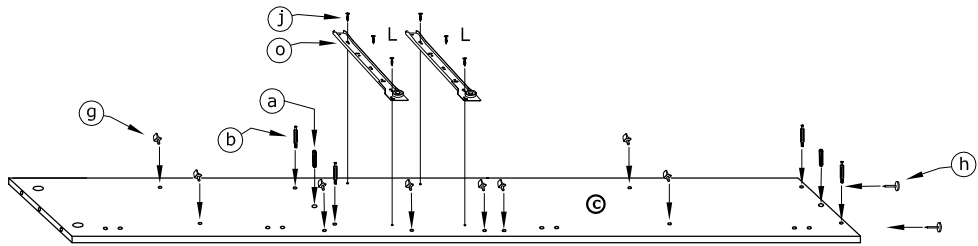
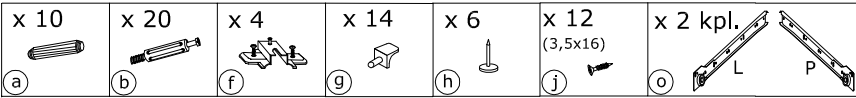

3

- x 20
- (c)
- x 12
- (d)

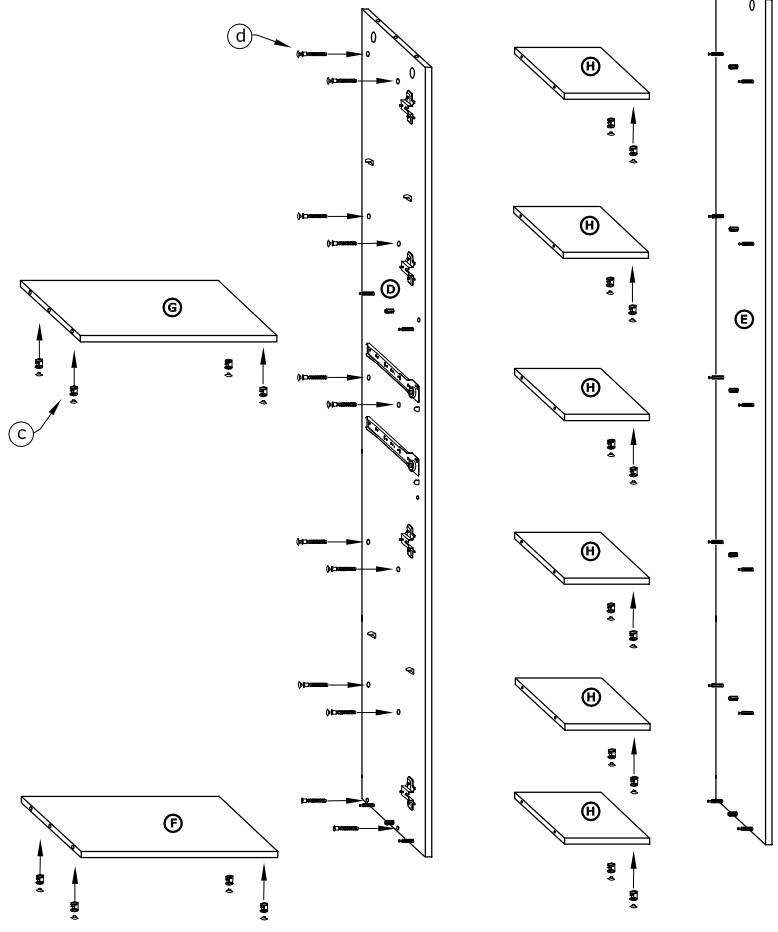
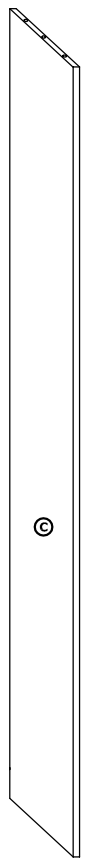

4

- x 8
- (c)
- x 2
- (d)

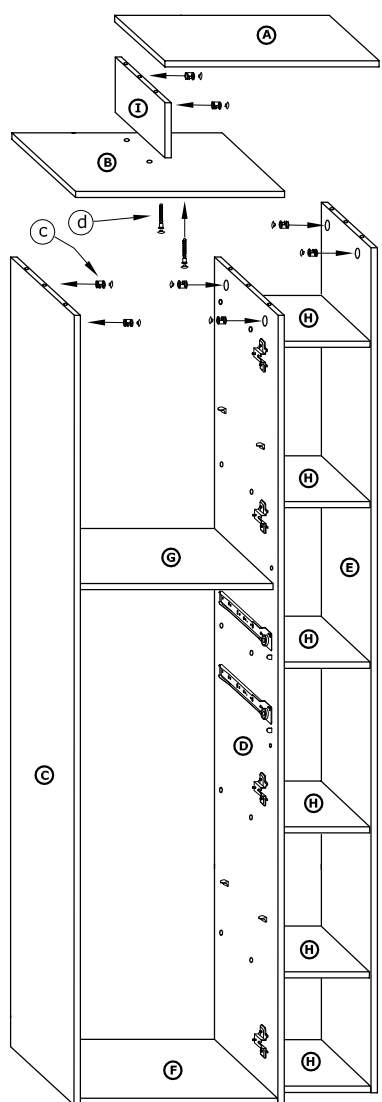

5

- x 40
- (m)

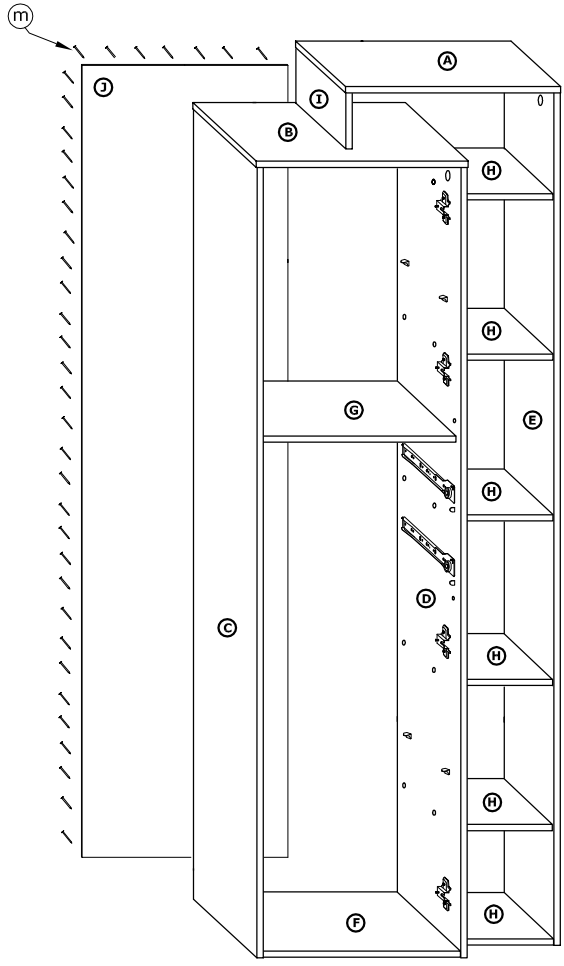

6

- | | | | |
|------------|-------------|-------------------------|------------------------|
| x 8
(d) | x 4
(i) | x 12
(3,5x16)
(j) | x 4
(3,5x30)
(k) |
| x 2
(l) | x 30
(m) | x 2 kpl.
(o) P L | |

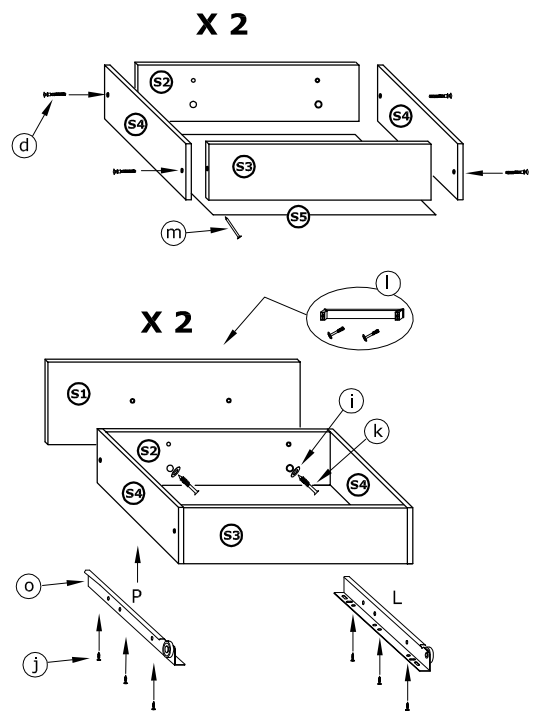

7

- x 4
(e)
- x 8
(3,5x16)
(j)
- x 4
(3,5x30)
(k)
- x 2
(l)

