

Model :

ALA 07 - Bieliźniarka 1D

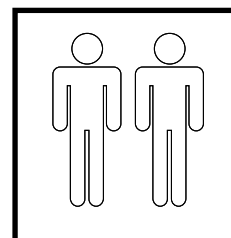

**KIELECKA
FABRYKA
MEBLI**



Przed przystąpieniem do montażu należy sprawdzić zawartość paczek pod względem ilości i jakości z instrukcją montażu.

NIE WOLNO montować uszkodzonych elementów mebli, ewentualne ich wady należy zgłosić przed montażem w przeciwnym razie nie będą one podlegać reklamacji.

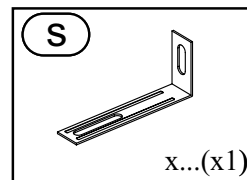
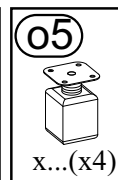
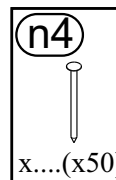
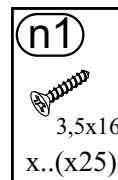
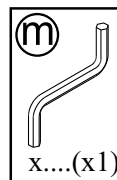
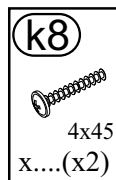
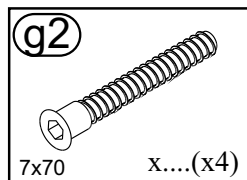
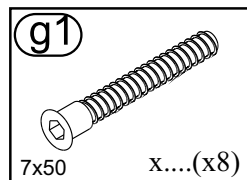
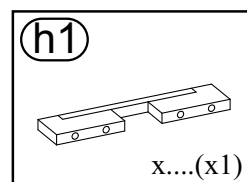
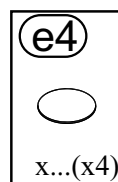
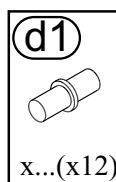
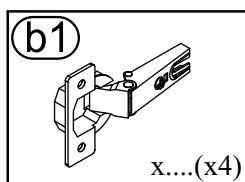
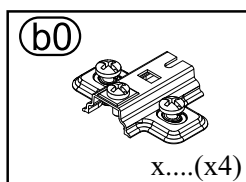
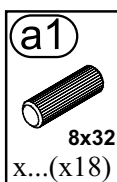
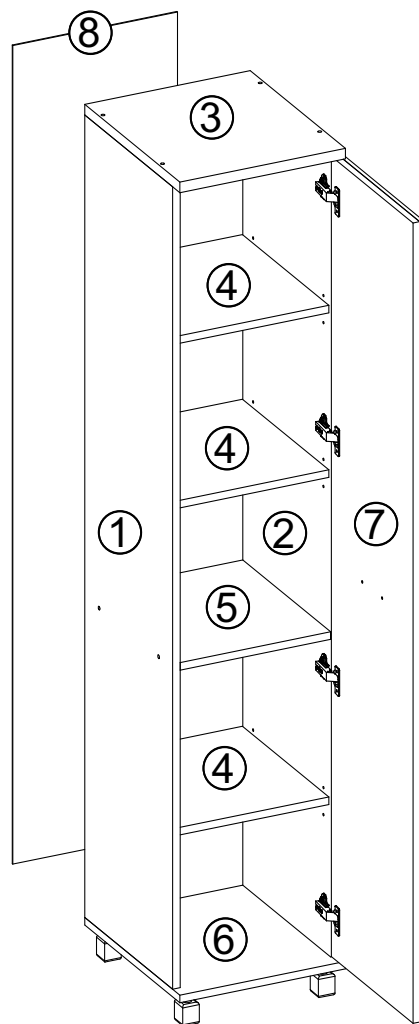

tel. 41 331 63 40,
fax.41 331 64 11
e-mail:biuro@k-f-m.pl
<http://www.kieleckafabrykamebli.pl/>

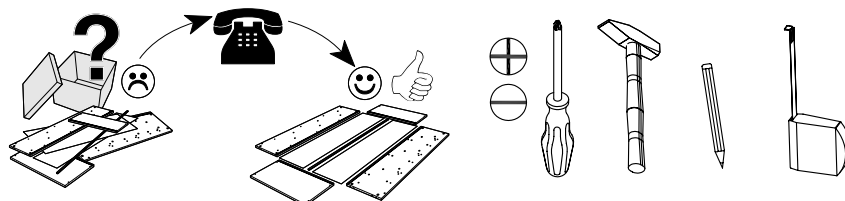

1

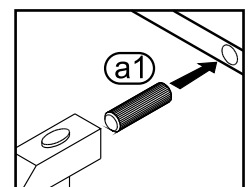
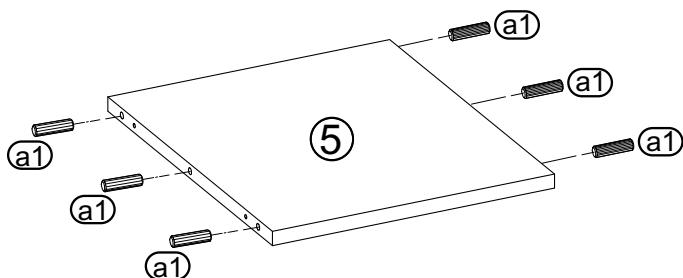
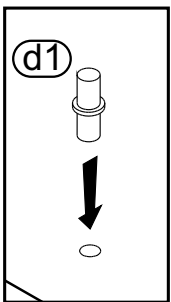
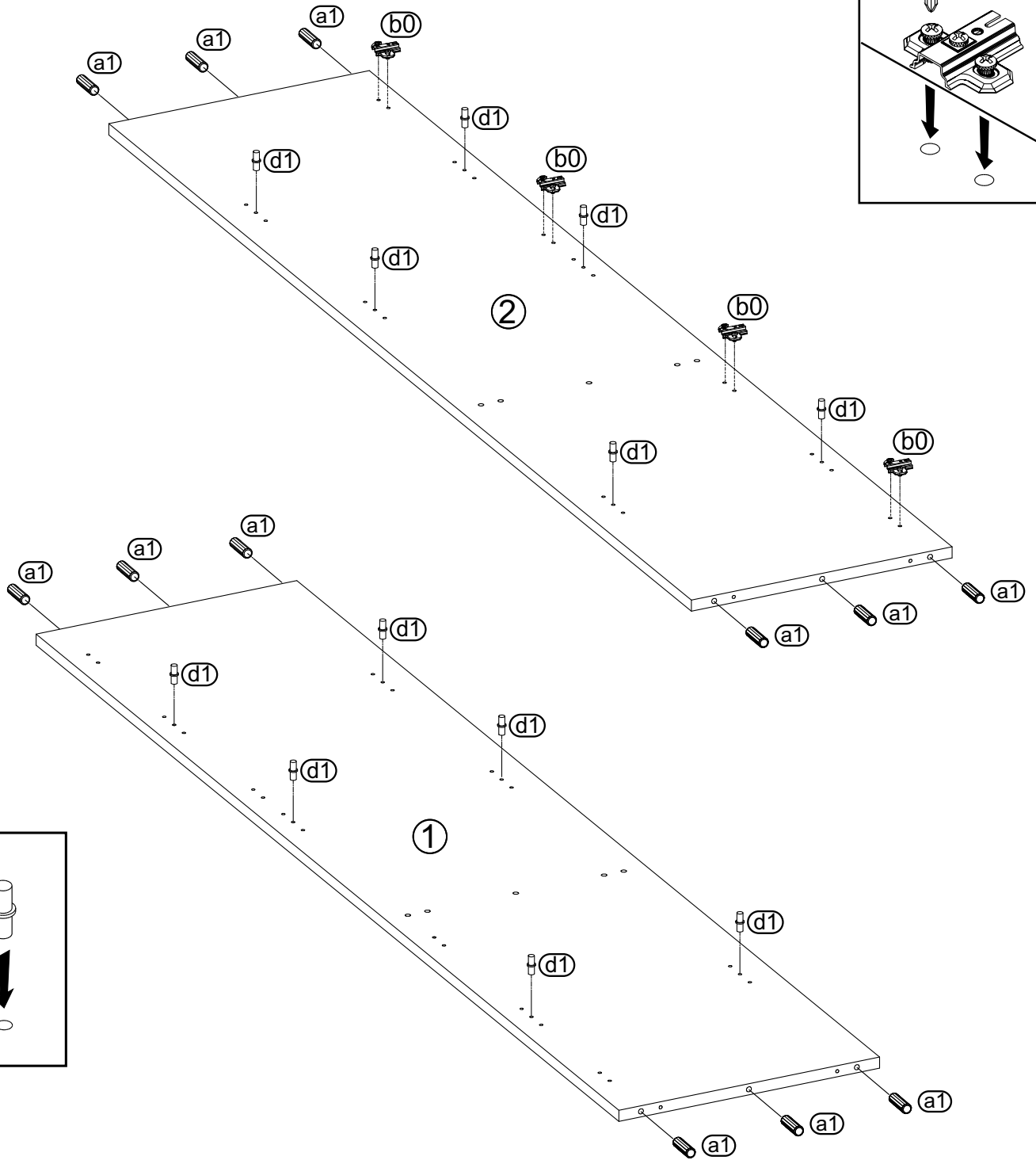
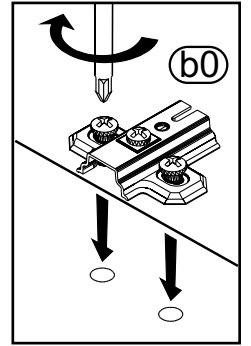

2

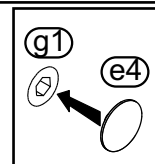
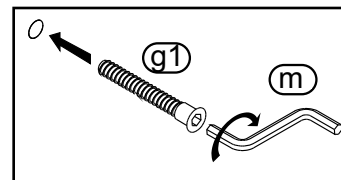
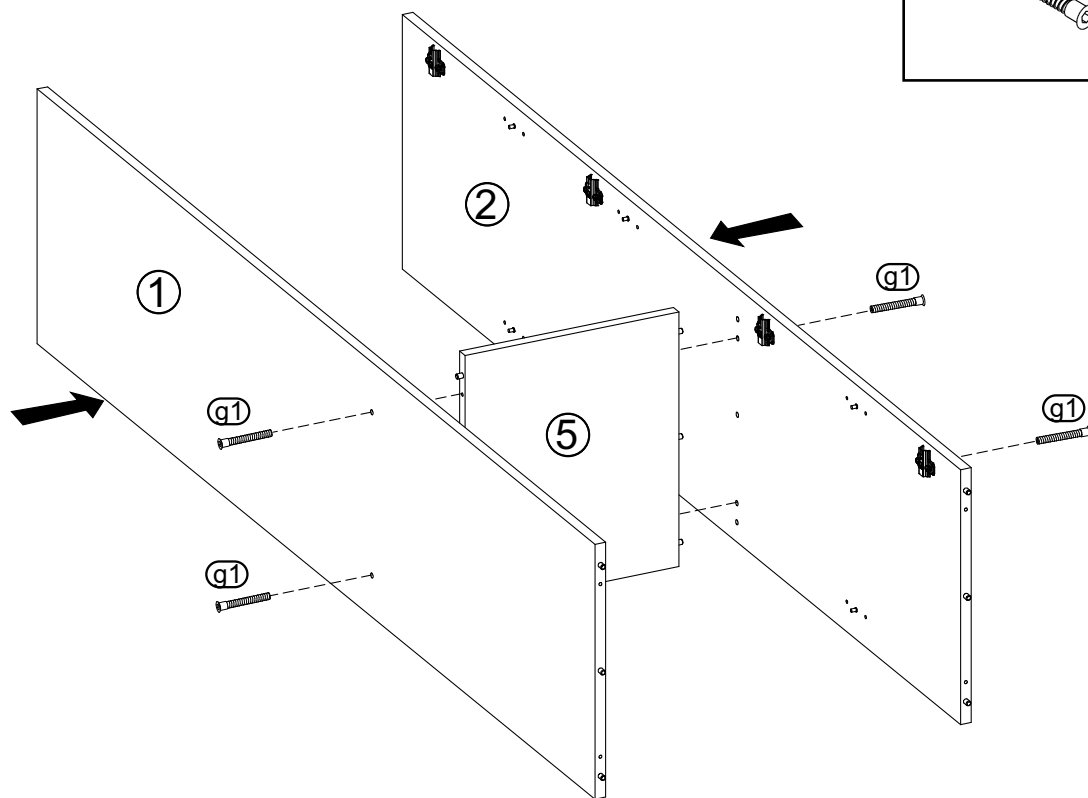

3

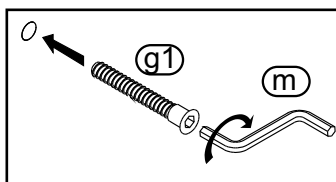
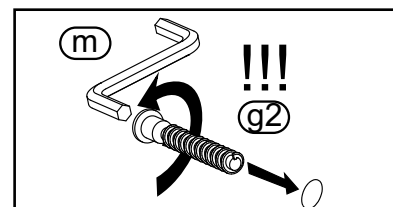
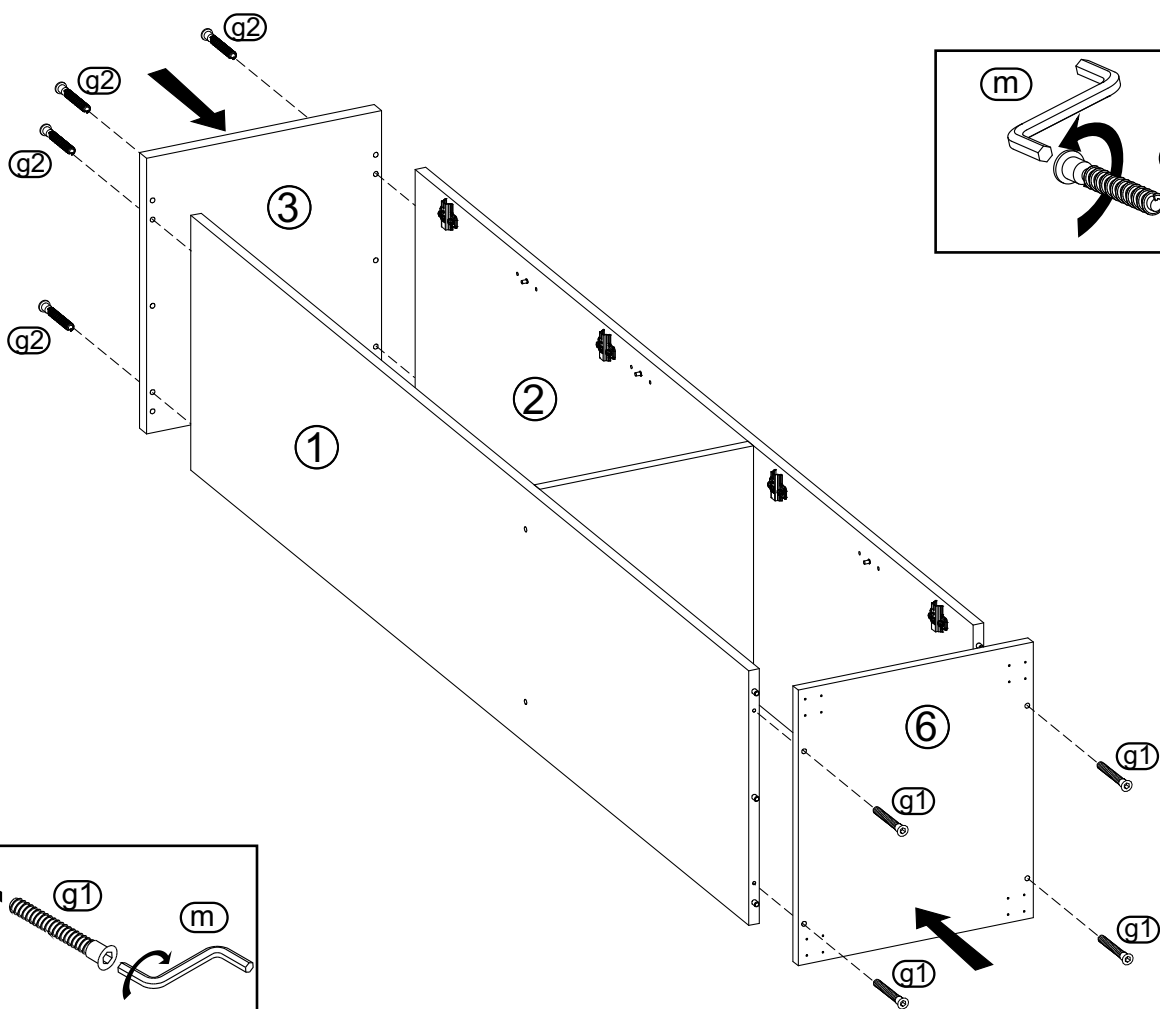

4

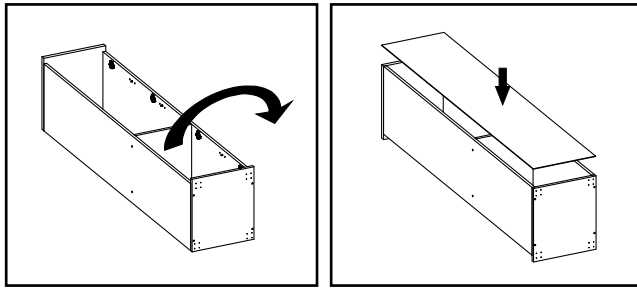

Uwaga !!!
 Przed zamocowaniem ściany tylnej należy zmierzyć przekątną szafki. Jeżeli wymiary są jednakowe to możemy przystąpić do zamocowania jej, jeżeli nie to musimy do tego doprowadzić ściskając przeciwległe rogi szafki, tam gdzie wymiar był większy.

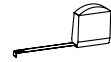
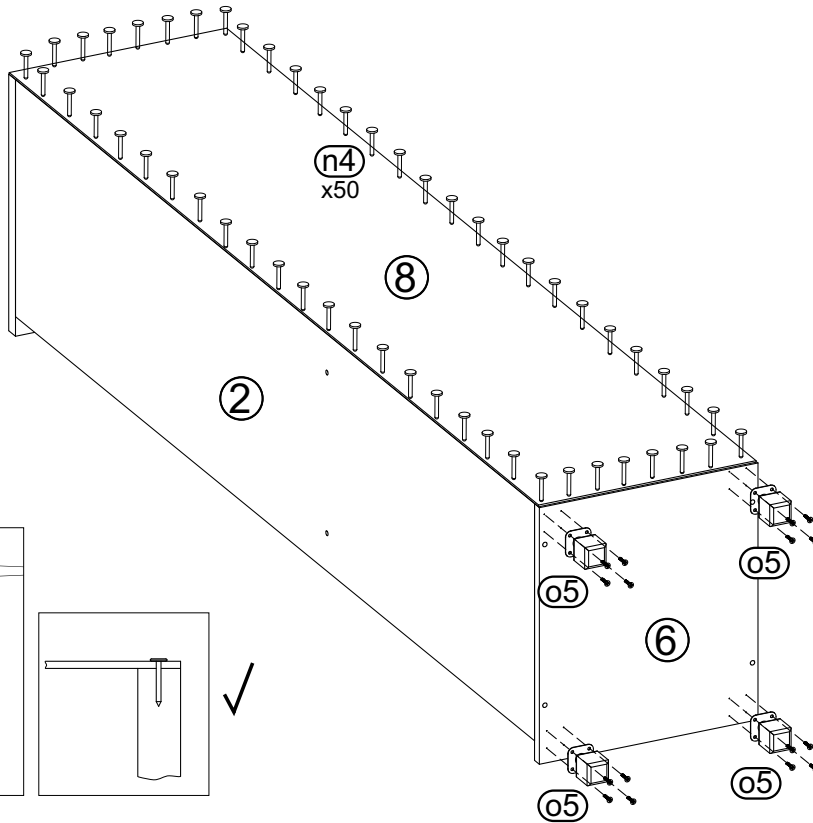

A=B

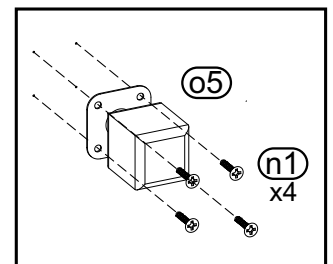
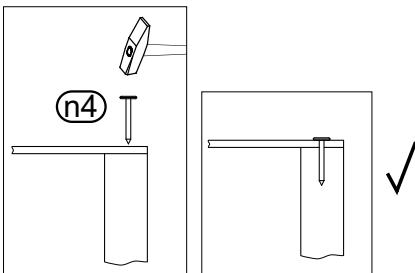
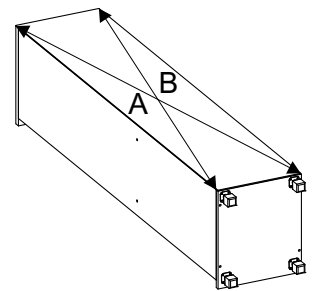

5

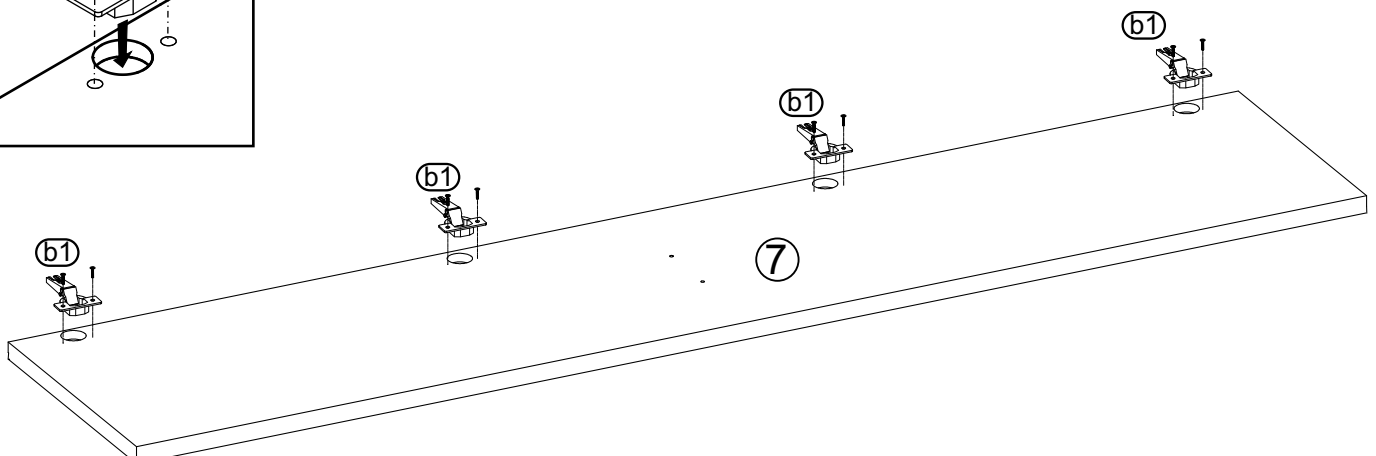
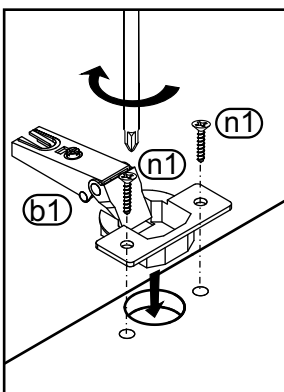

6



UWAGA!

Mebel należy trwale zamocować do ściany, aby uniknąć ryzyka związanego z przewróceniem się mebla. W paczce nie ma śrub mocujących, ponieważ rodzaj mocowania należy odpowiednio dobrać do rodzaju ściany. Dobierz właściwe do twojego rodzaju ściany.

