











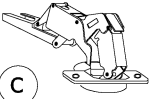
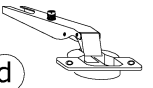
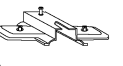

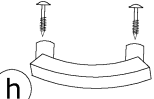
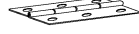
x 32  a	x 21  b	x 4  c	x 4  d	x 8  e	x 16  f
x 6  g	x 5  h	x 3  i	x 2  m		
x 4 (ø6x18x2)  o	x 8 (3,5x30)  p	x 70 (3,5-16)  r	x 8 (6,3-13)  s	x 8  t	 60 min
x 8  w	x 1  z	x 100  x	x 1  y	x 1  q	
x 1  i	x 1 (1400 mm)  j	x 2 (400 mm - kpl.)  k		x 1 (772 mm)  n	

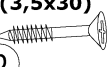
1 - FAZY MONTAŻU

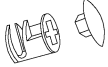
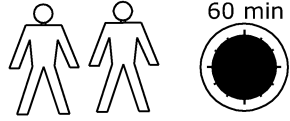
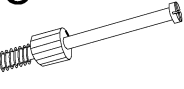
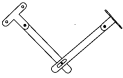
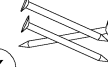
A - OZNACZENIE ELEMENTÓW

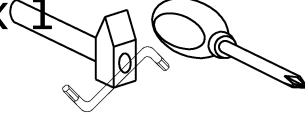
a - OZNACZENIE AKCESORIÓW

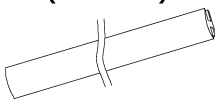
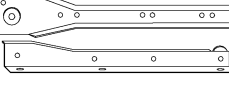
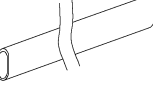
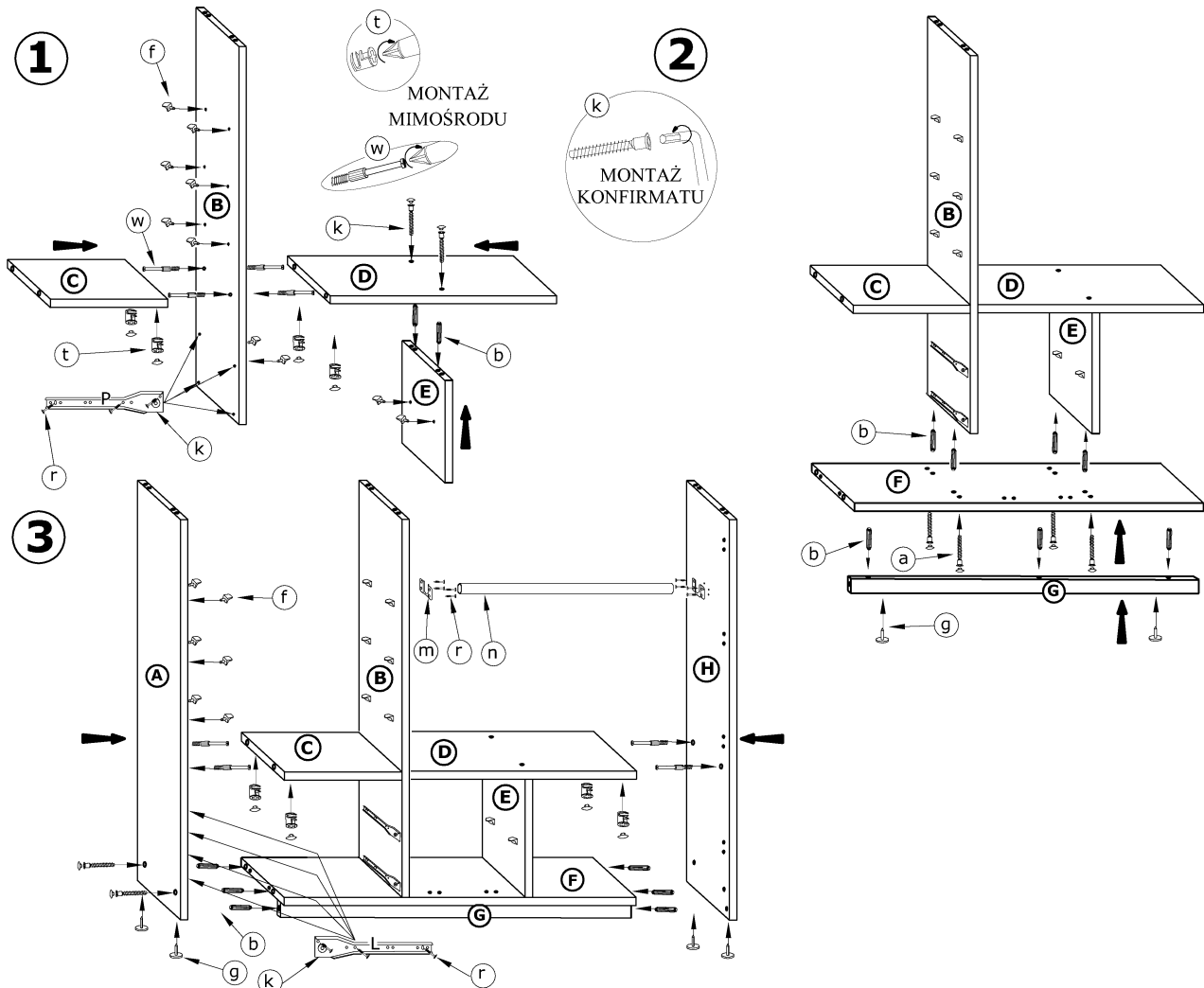

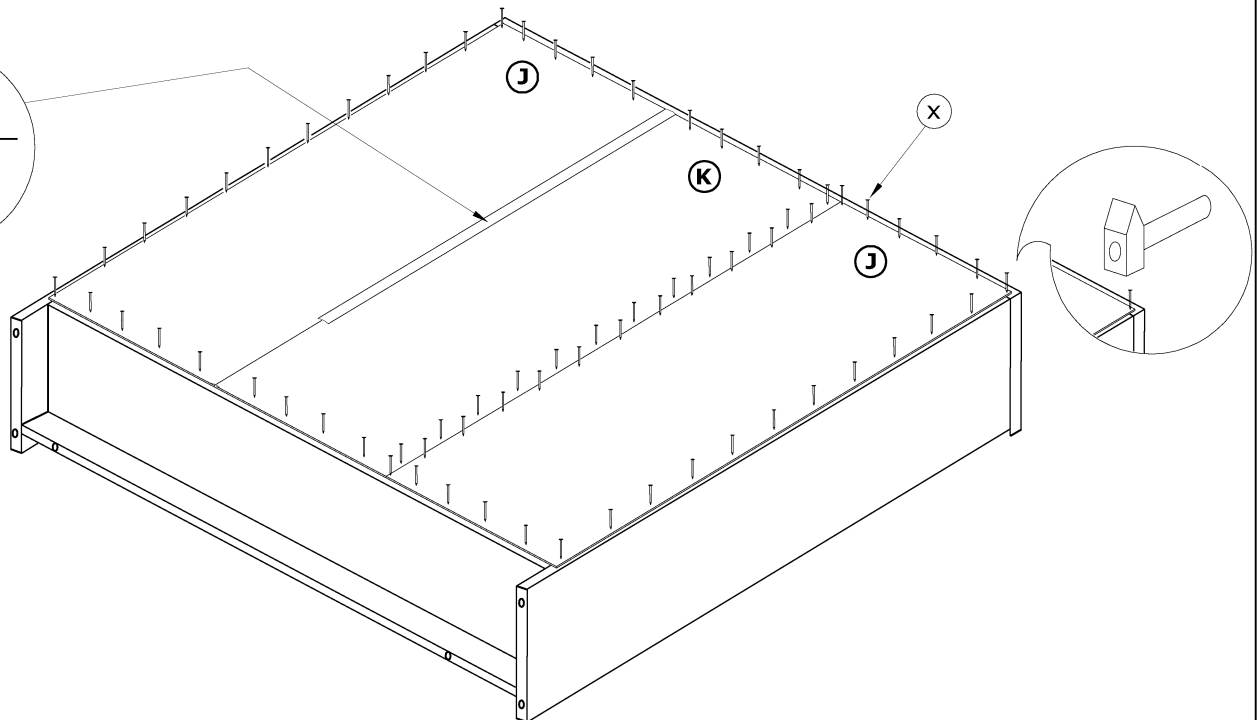
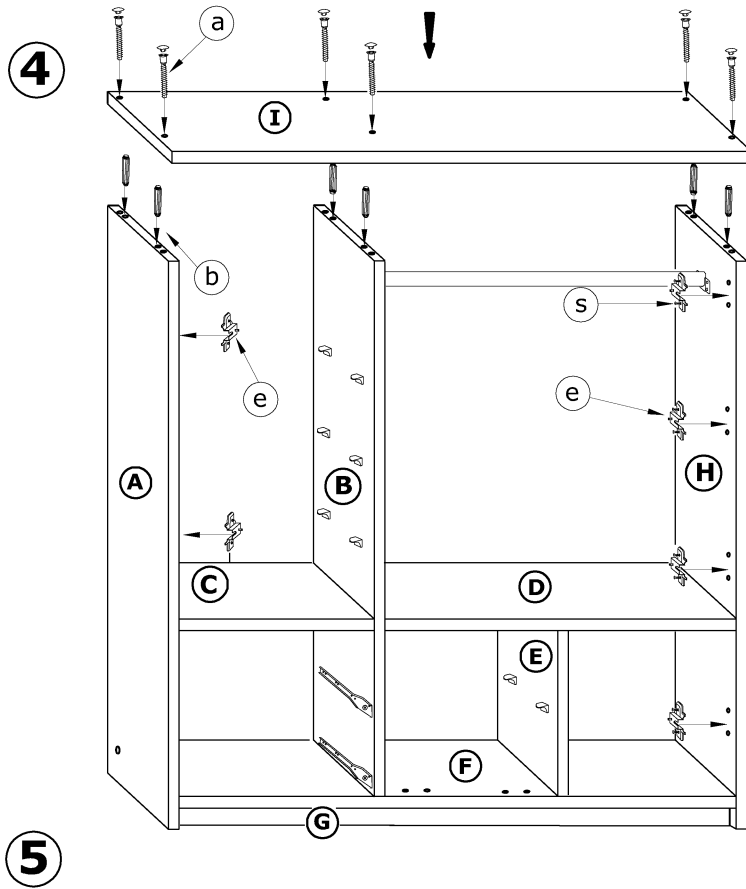

6

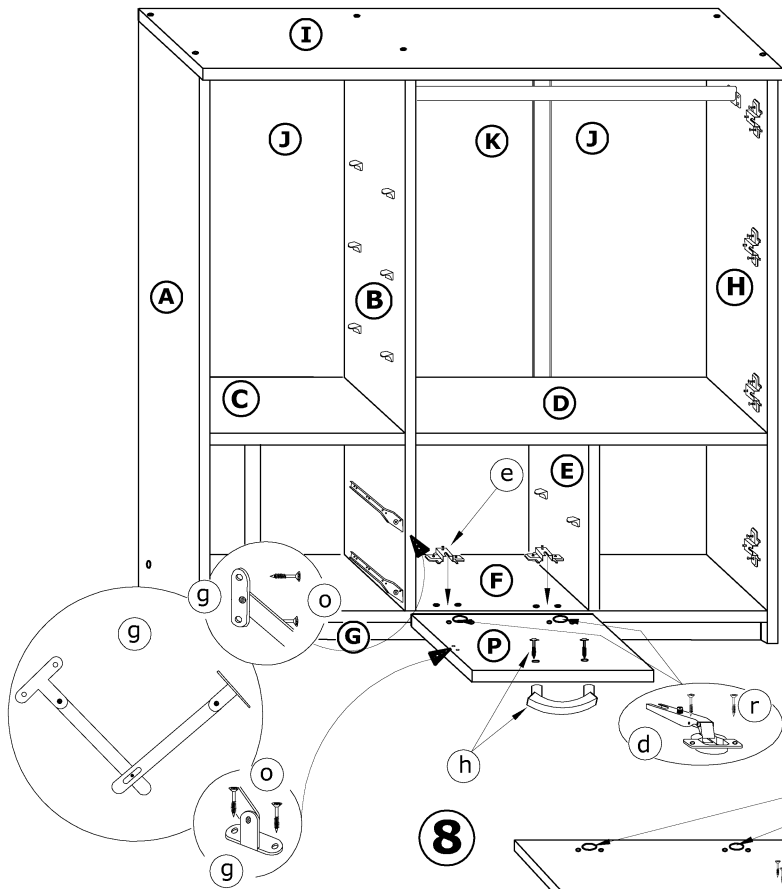

7

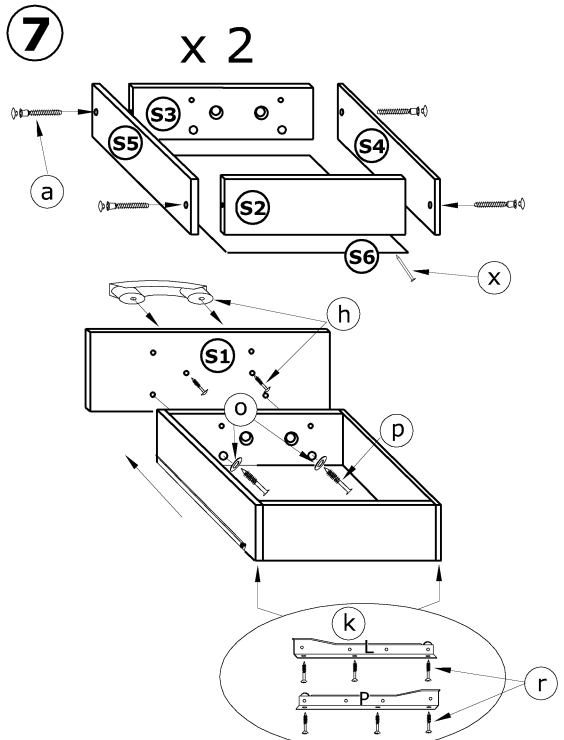

8

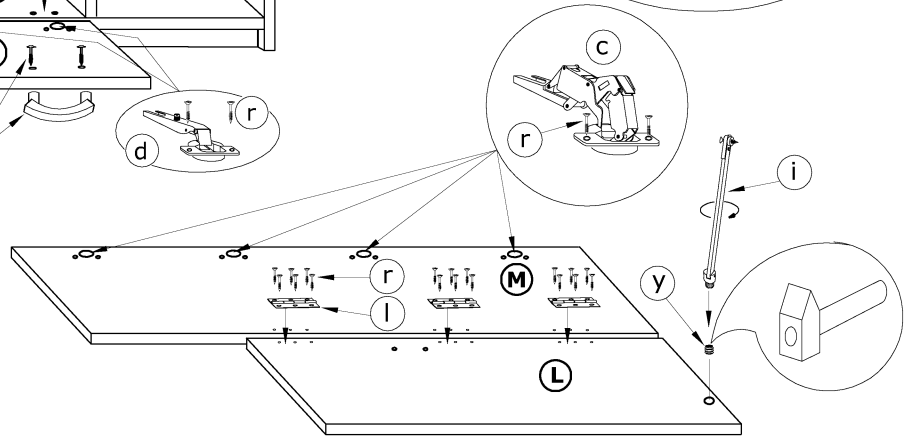

9

