

PL INSTRUKCJA MONTAŻU
CZ NÁVOD K MONTÁŽI
D MONTAGEANLEITUNG
GB ASSEMBLY INSTRUCTIONS
F MODEL D'EMPLOI

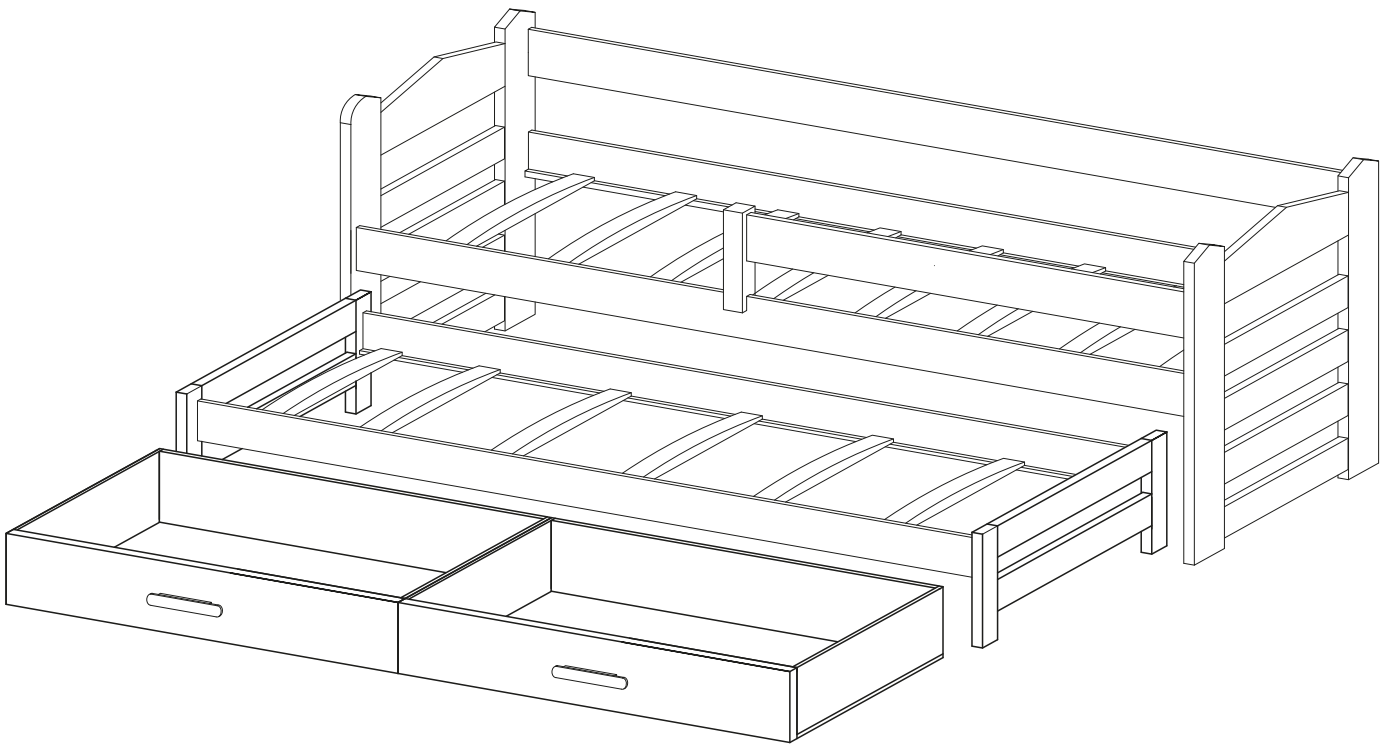
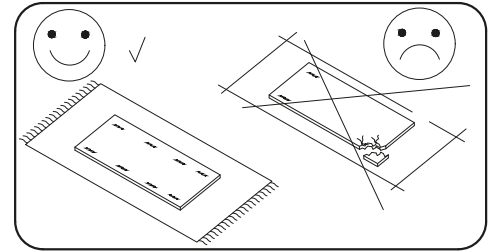
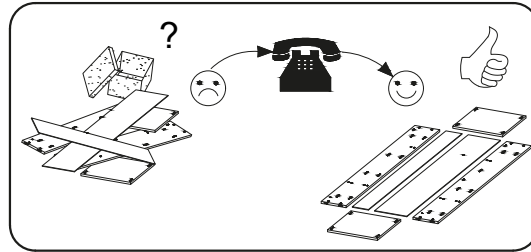
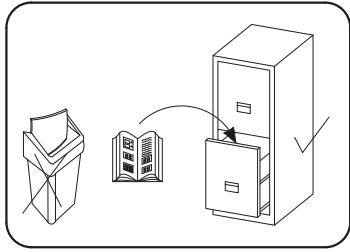
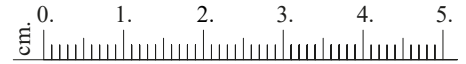
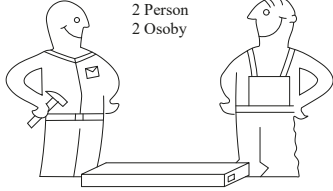

Uwaga Upozornění Achtung Caution Attention

Czyszczenie należy wykonać wyłącznie za pomocą ściereczki lub lekko nawilżonego ręcznika. Nie stosować środków czyszczących do szorowania.

Čištění je nutné vykonávat výhradně pomocí utěrky nebo lehce navlženého ručníku. epoužívejte čisticí prostředky obsahující abrazivní částice

Bitte nur mit einem Staubtuch oder leicht feuchtem Lappen reinigen. Keine scheuerenden Putzmittel verwenden.

Please only clean with a duster or a damp cloth. Do not use any abrasive cleaners.

Le nettoyage se fait uniquement à l'aide d'un torchon ou d'une serviette légèrement mouillée.

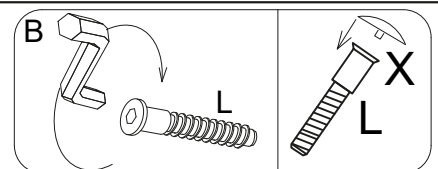
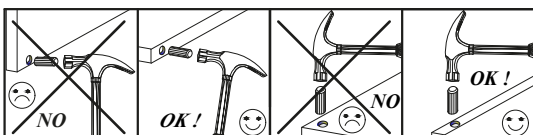

AKCESORIA / ACCESSORIES

L-85	Ø - 10.0mm				3.5x16	7.0X50	3.5x40	Ø - 8.0mm			
F	E	C	X	B	G	L	J	T	N	R	U
12	12	24	16	1	50	4	12	16	10	1	2

