

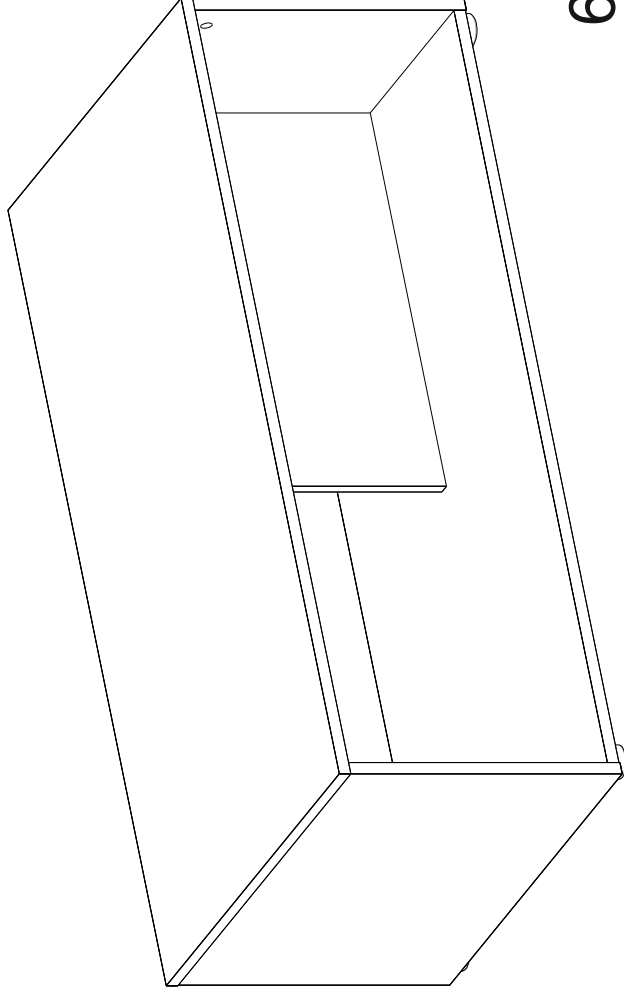

XXXXXXXXXXXX serie: xxx  
 .....  
 Hergestellt fur:  
 .....  
 .....

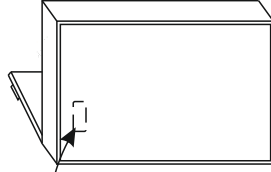

60 min 



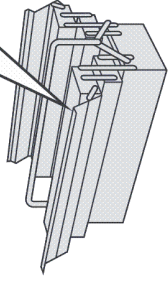
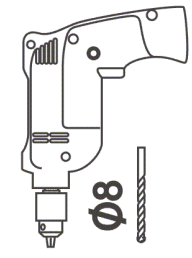
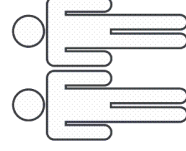
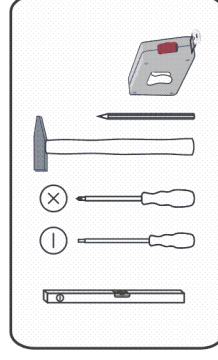
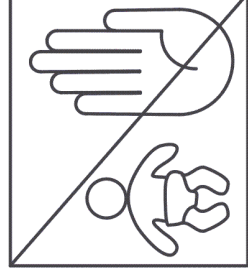
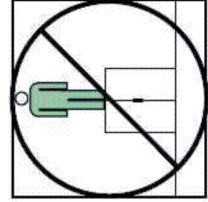
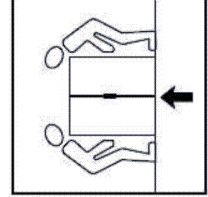
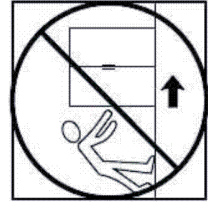
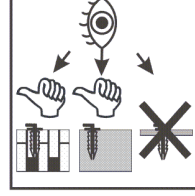
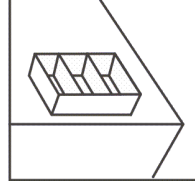
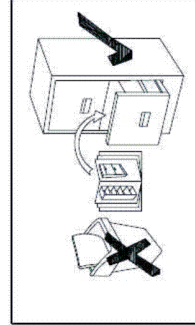
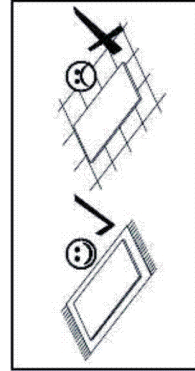
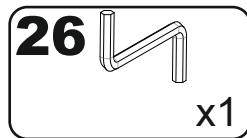
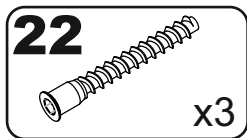
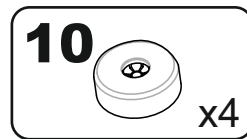
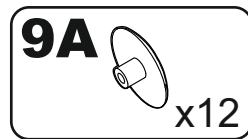
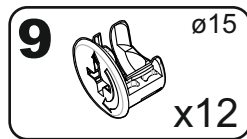
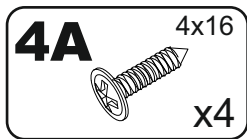
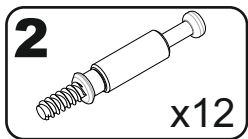
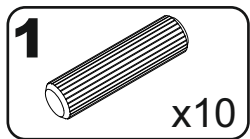
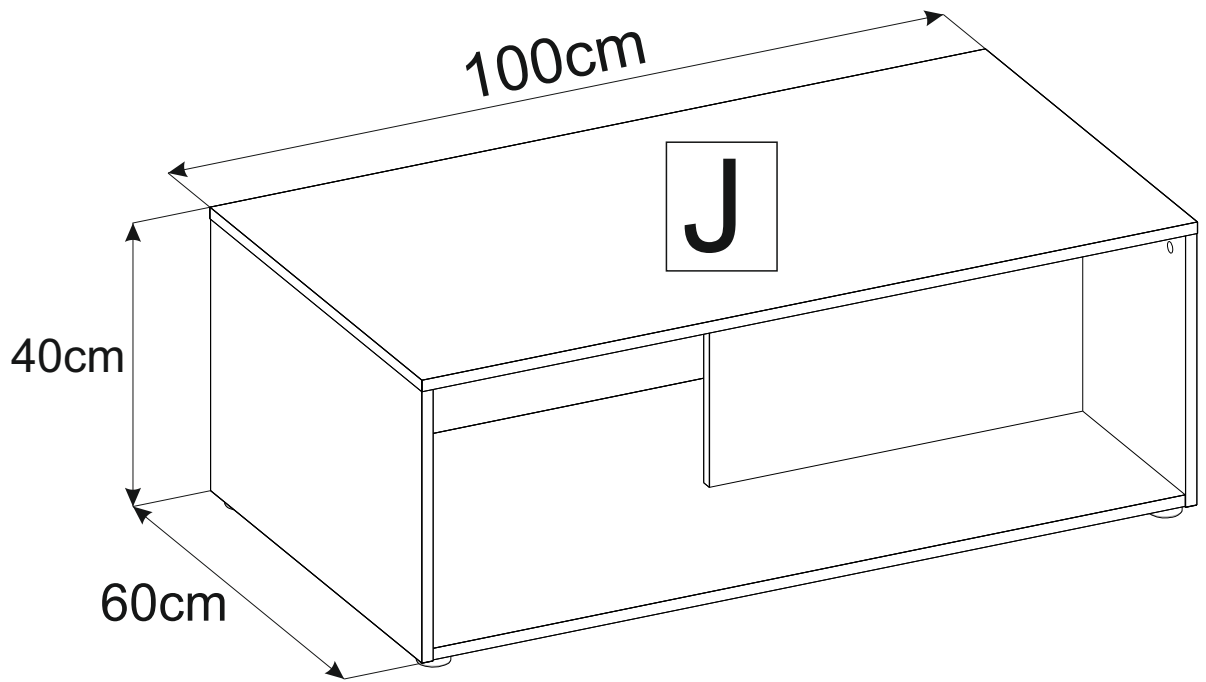
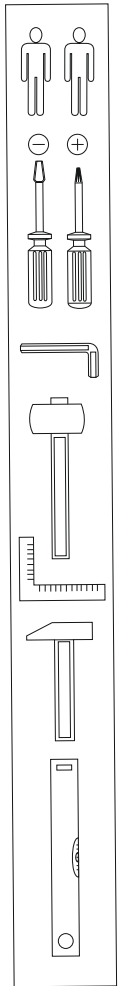

# J

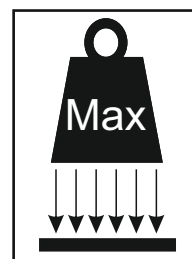
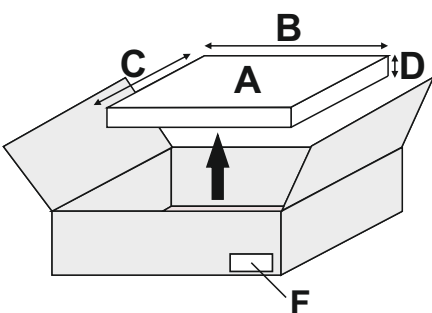
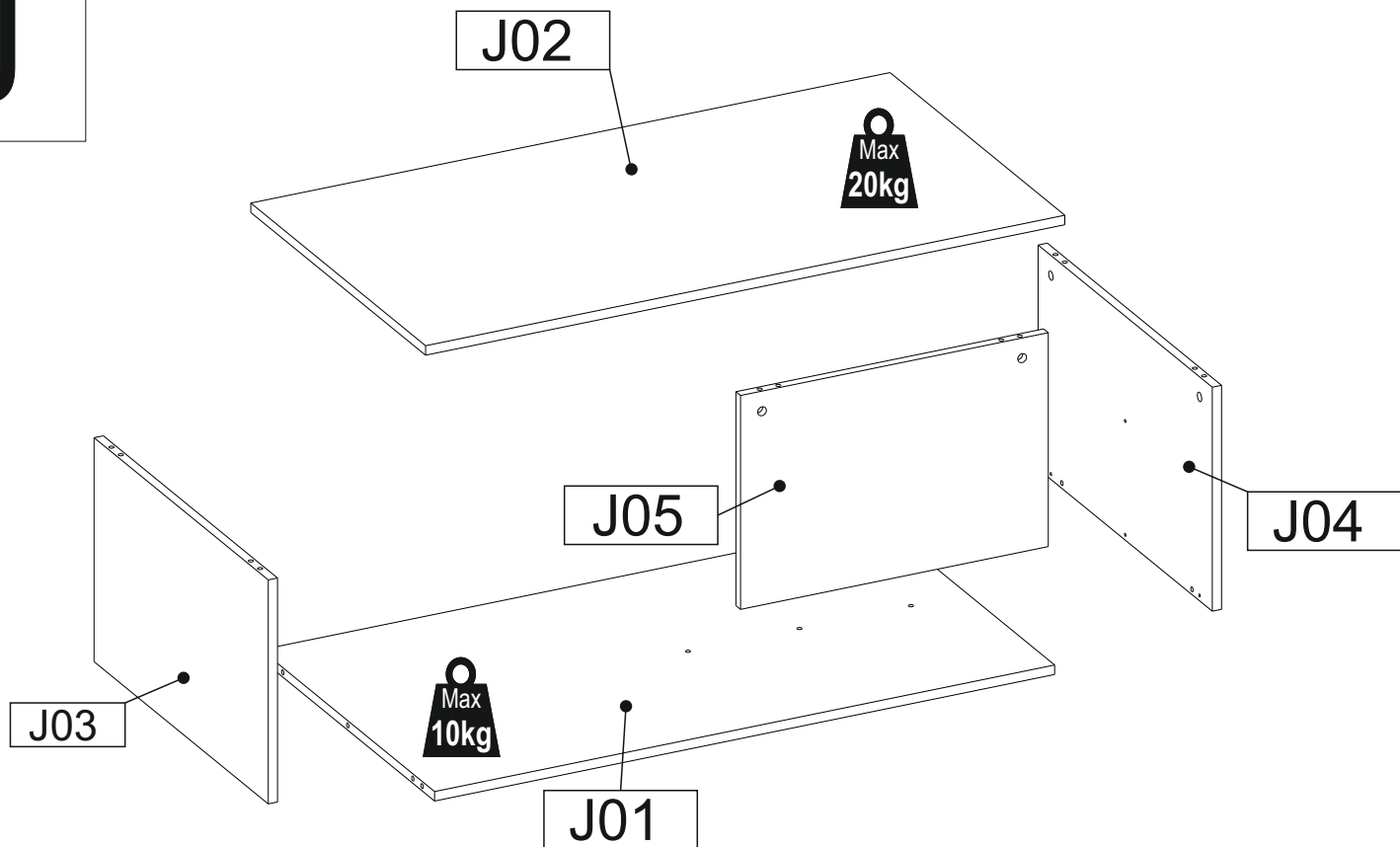

A	B_(mm)	C_(mm)	D_(mm)	E	F
J01	1068	598	16	1	1 1
J02	1101	602	16	1	1 1
J03	378	600	16	1	1 1
J04	378	600	16	1	1 1
J05	530	361	16	1	1 1

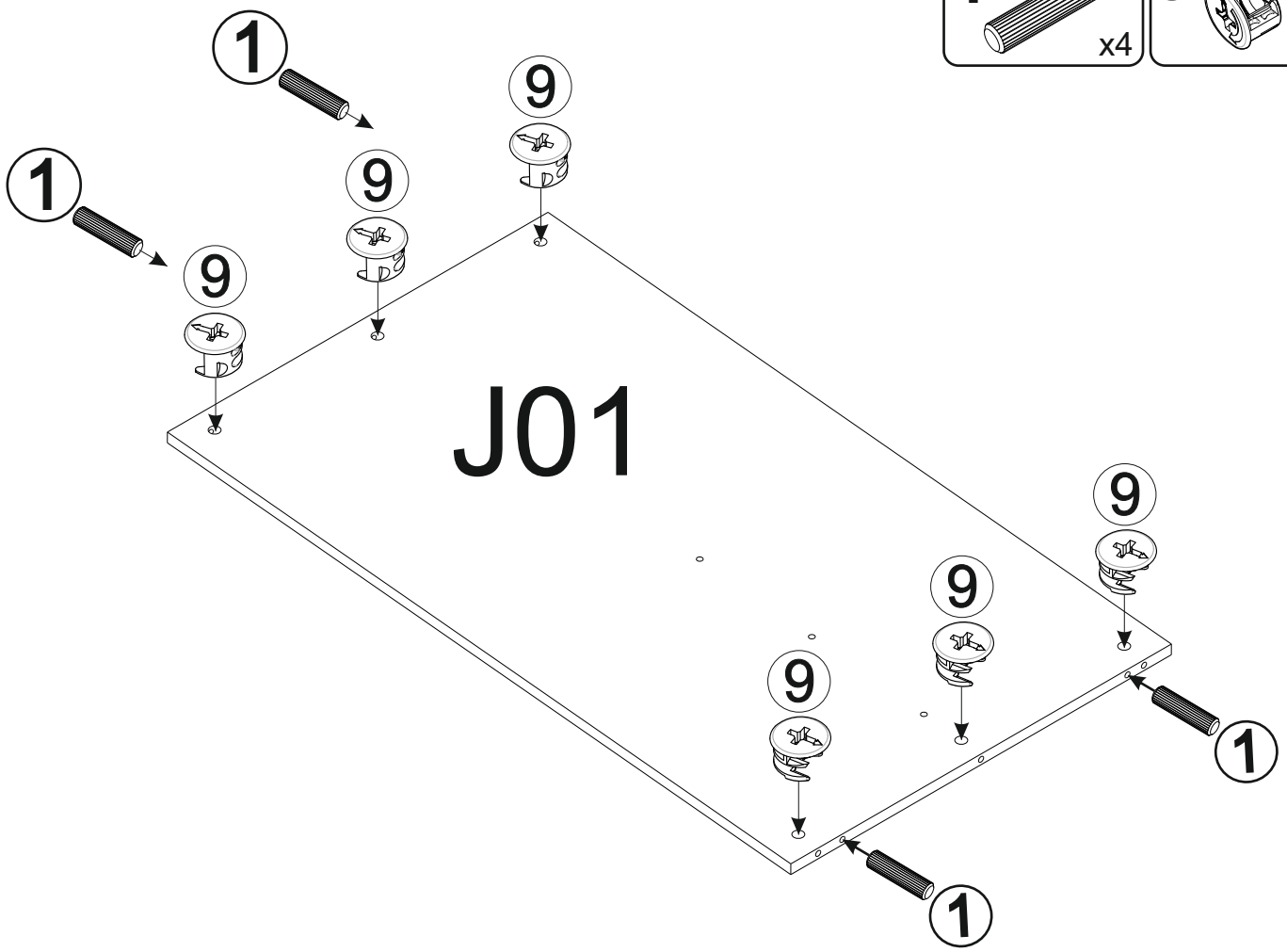

# 1

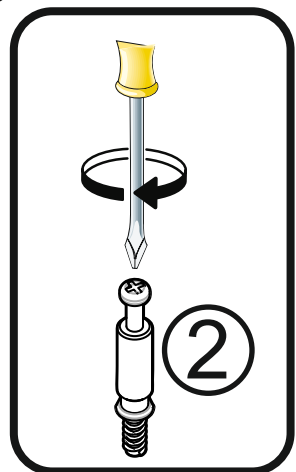
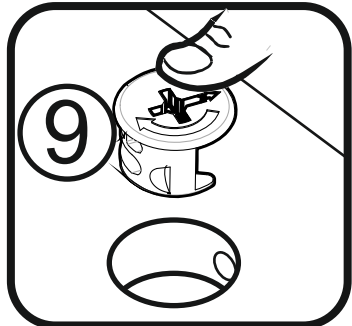
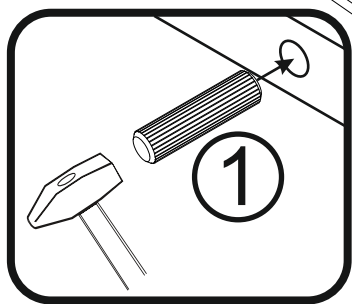
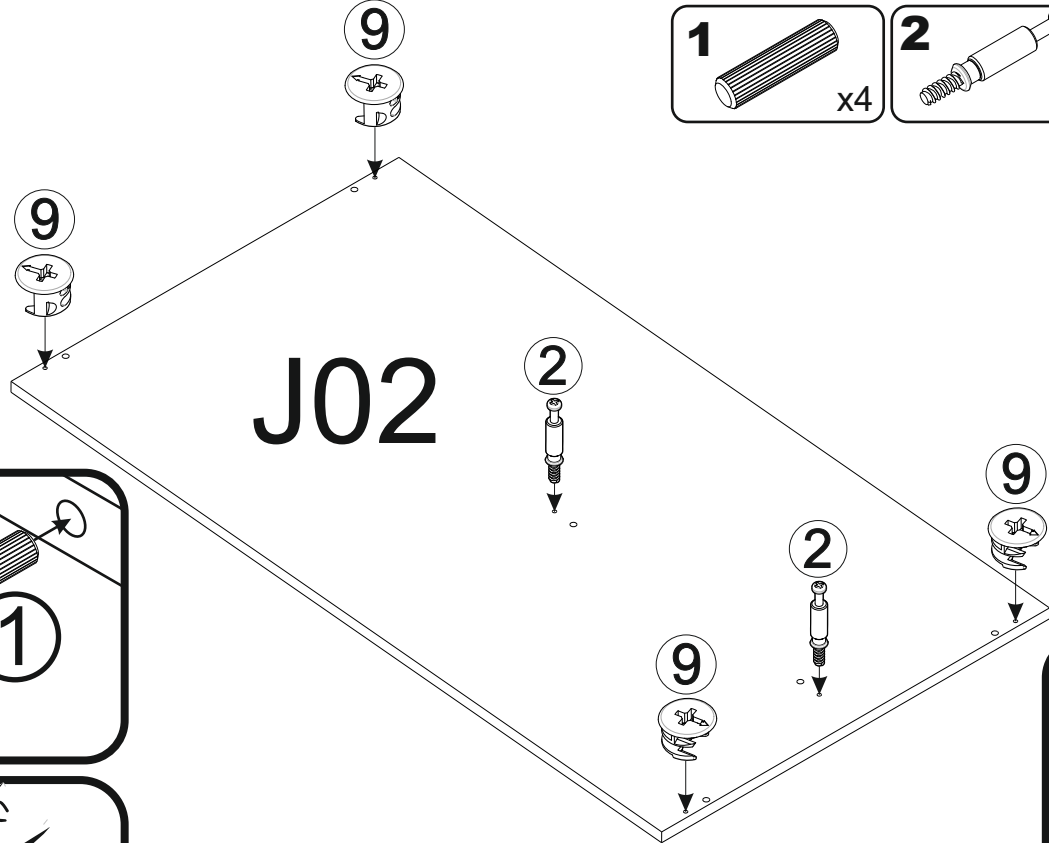
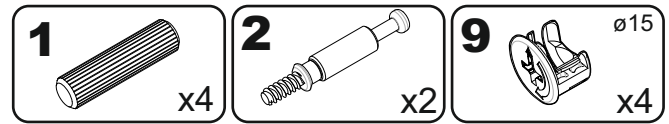

# 2

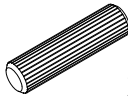
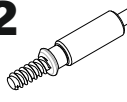

# 3

- 1**  x2
- 2**  x3
- 9**   $\varnothing 15$  x2

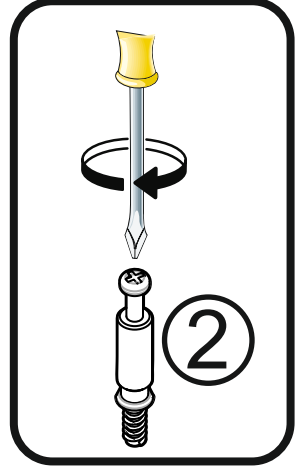
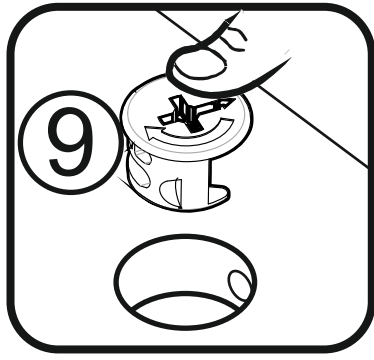
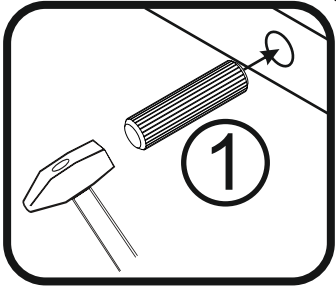
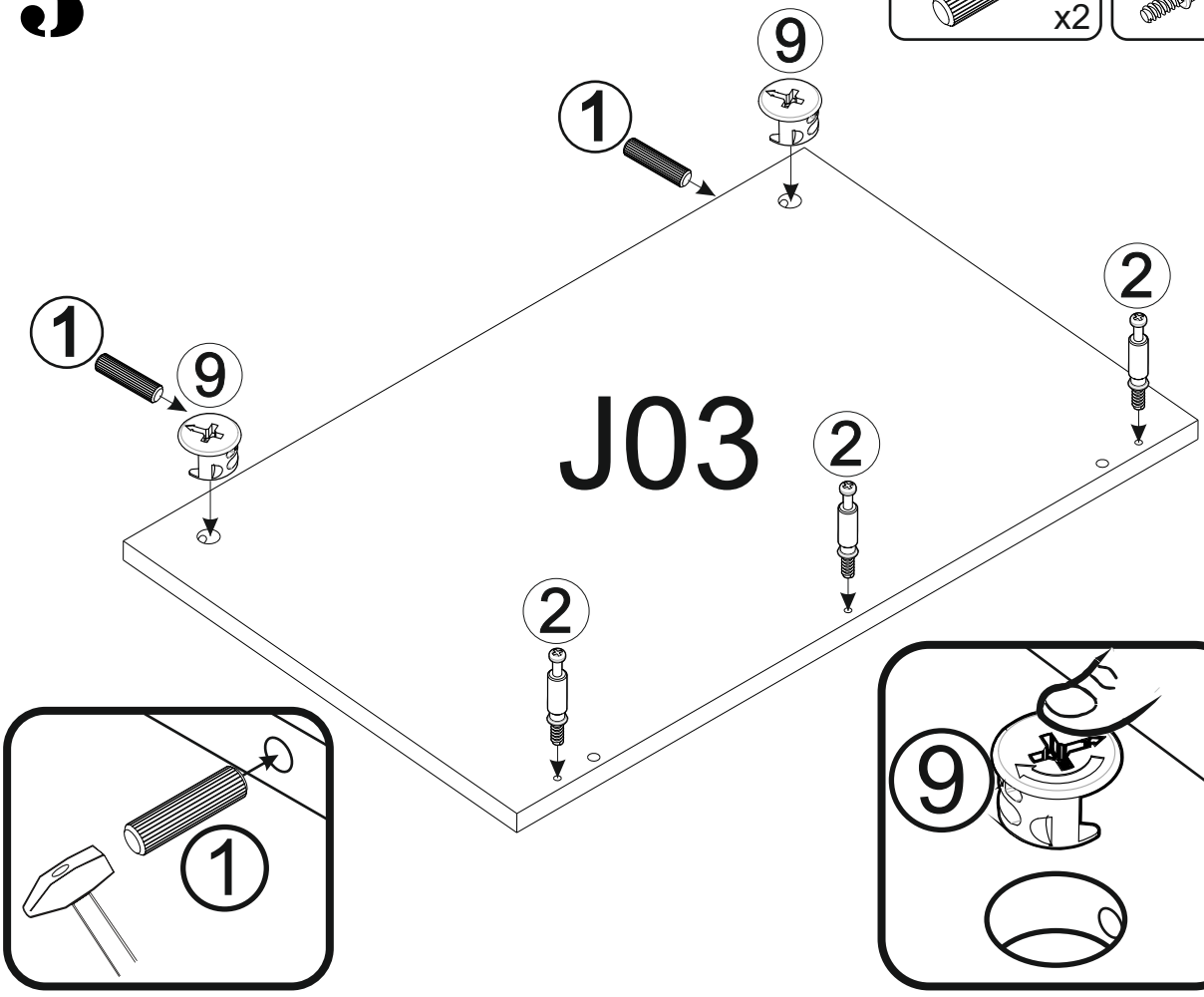

# 4

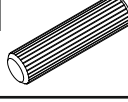
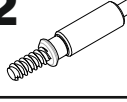
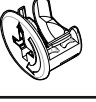
- 1**  x2
- 2**  x3
- 9**   $\varnothing 15$  x2

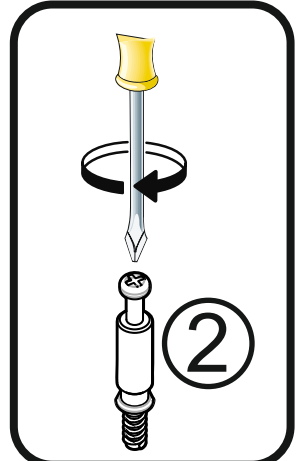
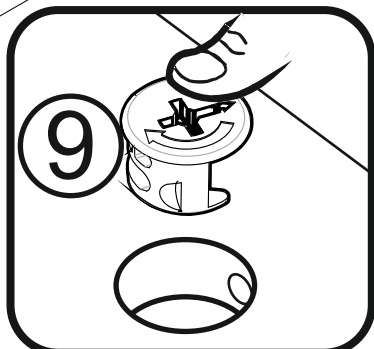
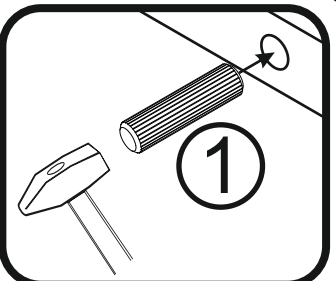
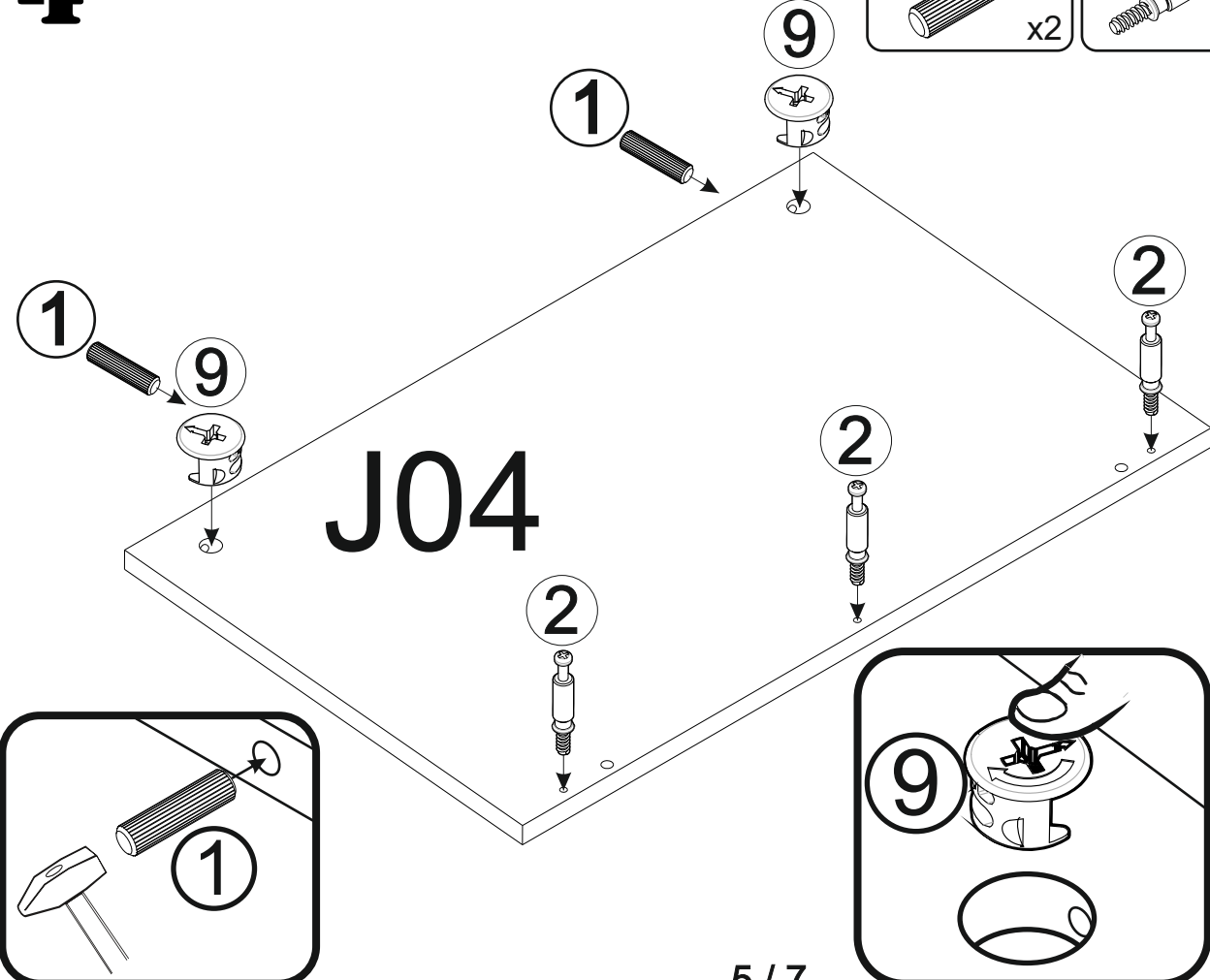

5

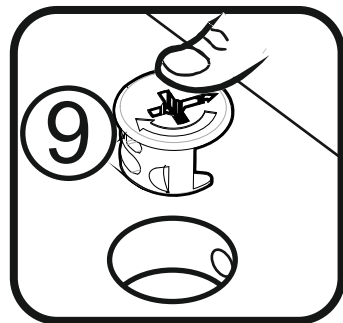
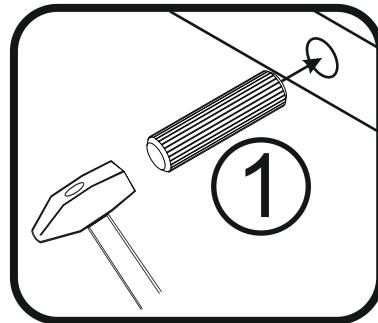
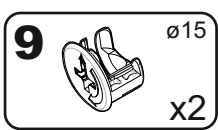
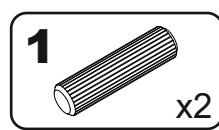
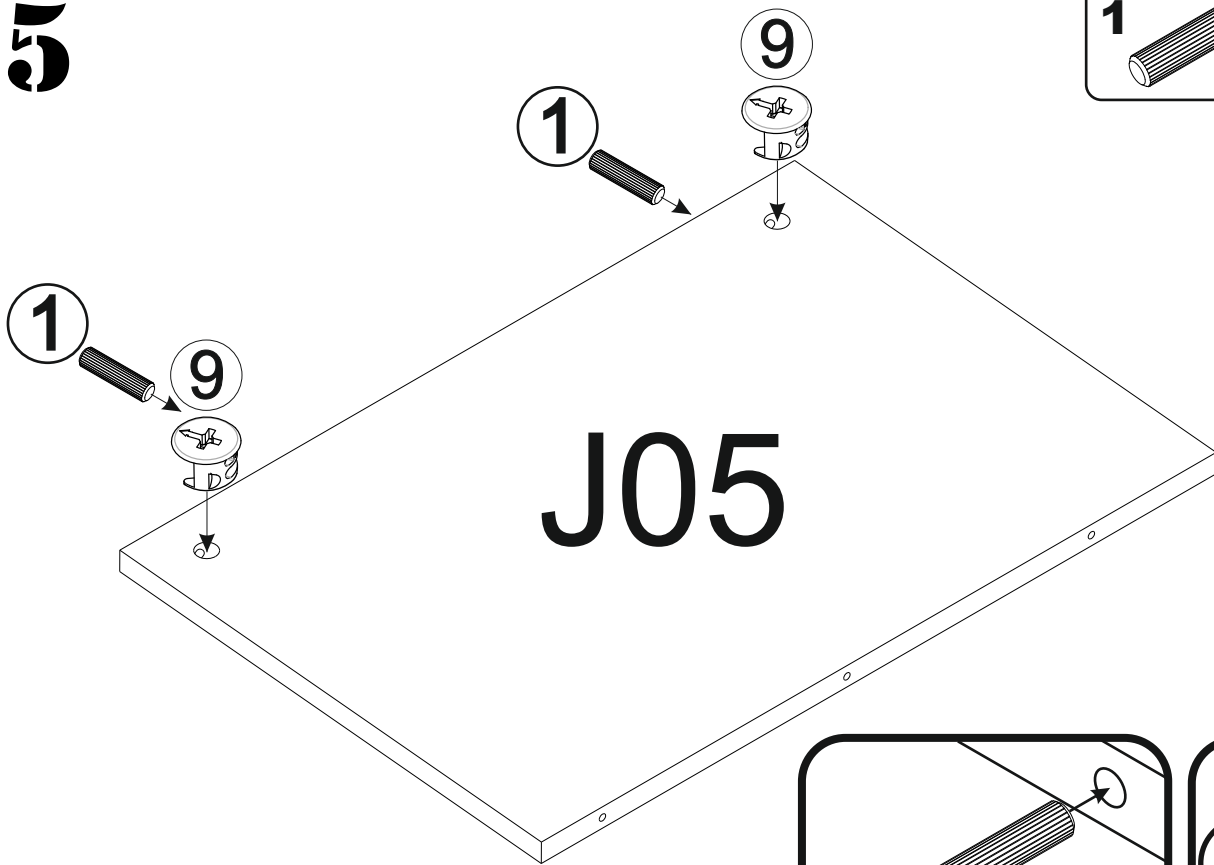

6

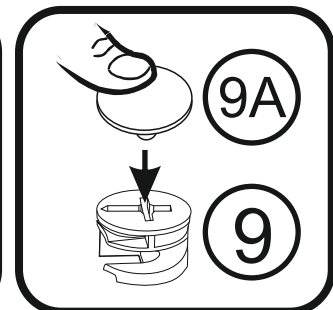
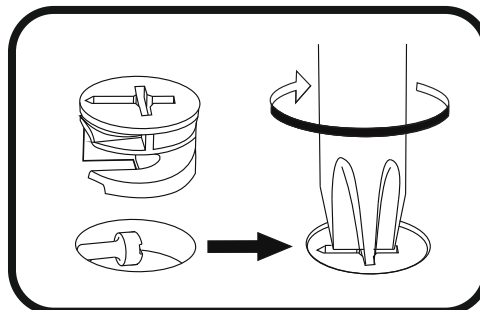
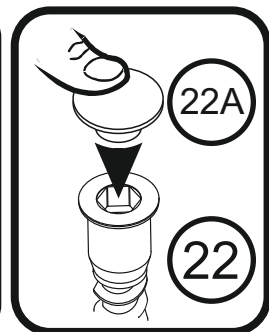
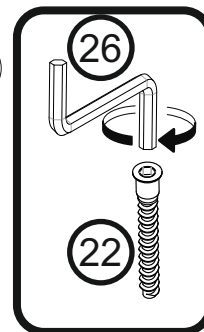
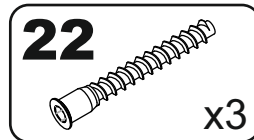
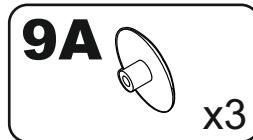
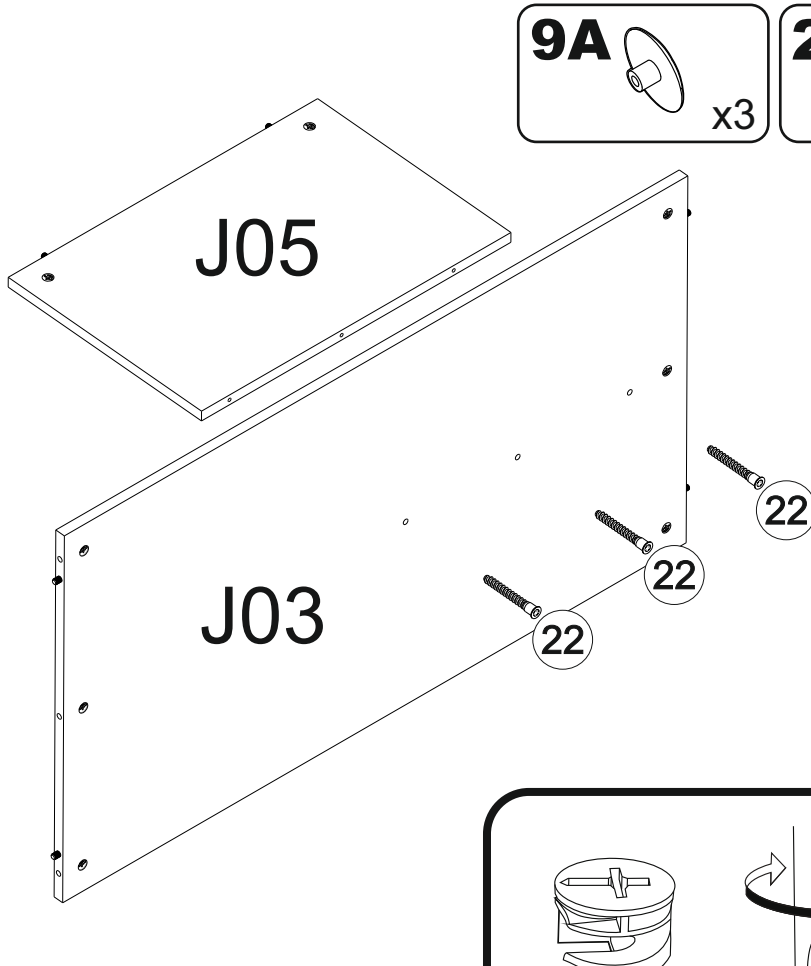

7

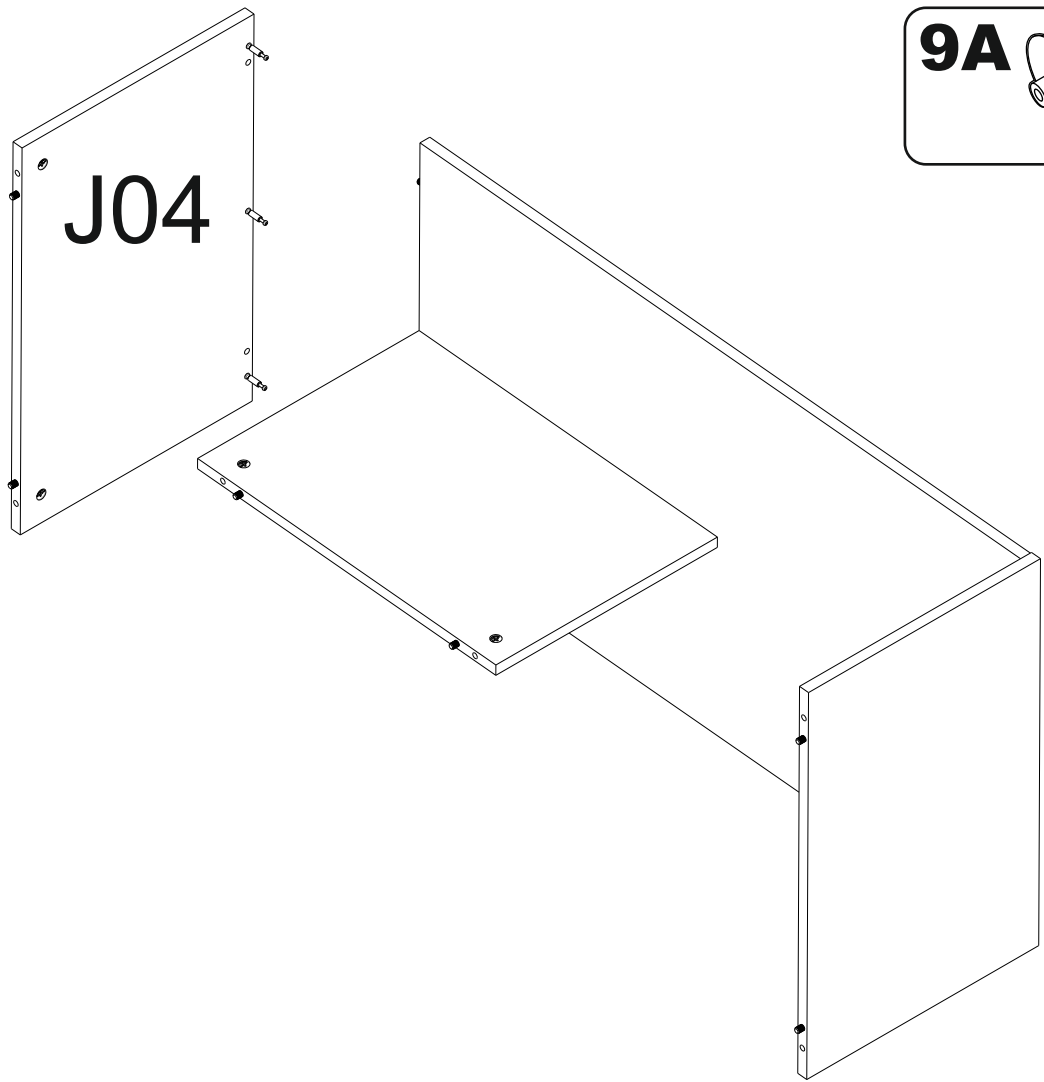

9A x4

8

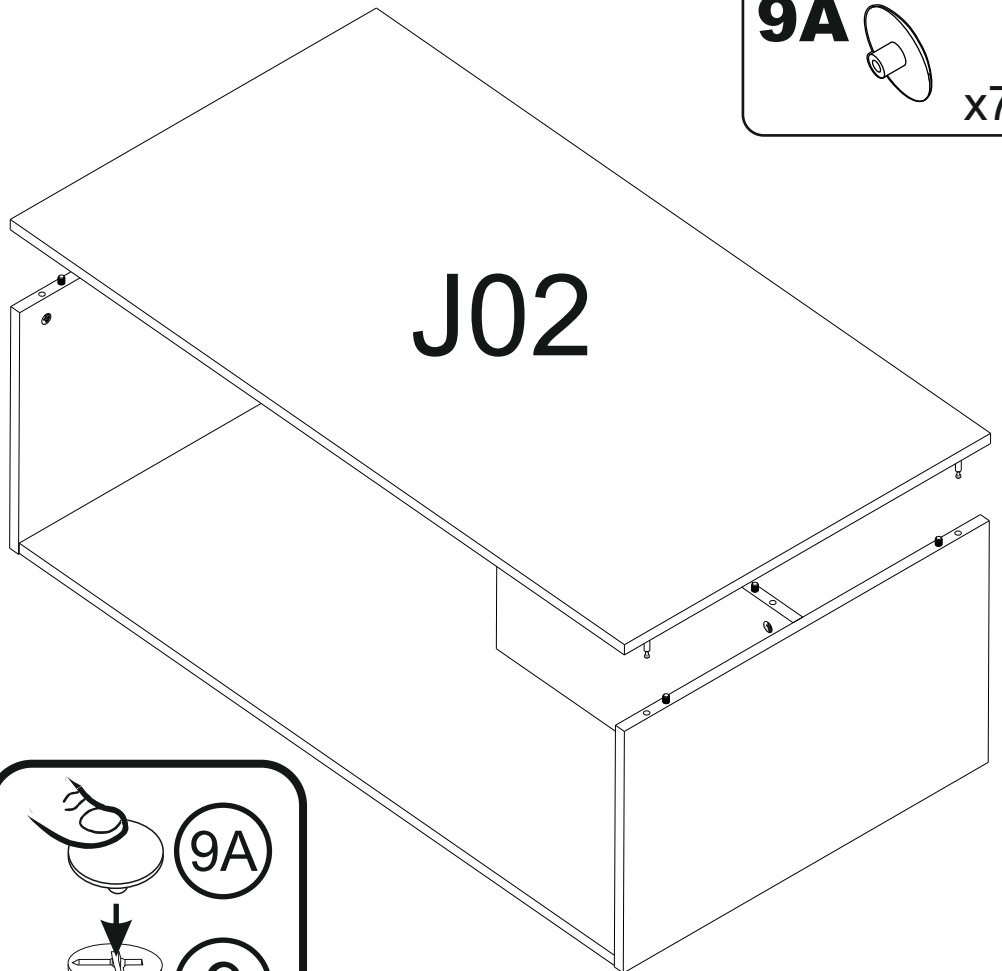

9A x7

